

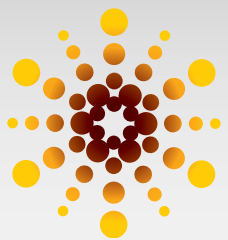

## STOCKED TOWERS CATALOG USA 2019

TITAN® SS SuperTITAN® KD SuperTitan® Weld SuperTITAN® MAX STG™



# Trylon

[www.trylon.com](http://www.trylon.com)



# Table of Contents

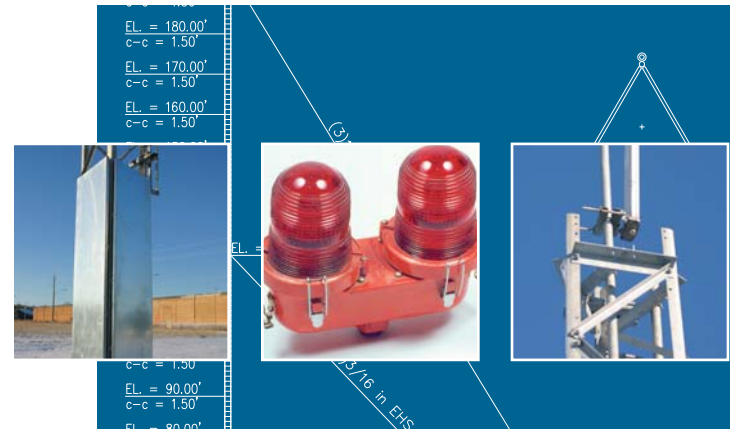

## Titan® Self-Support Tower ..... 1

Tower Comparison.....	2
16' Towers.....	3
24' Towers.....	4
32' Towers.....	5
40' Towers.....	6
48' Towers.....	7
56' Towers.....	8
64' Towers.....	9
72' Towers.....	10
80' Towers.....	11
88' Towers.....	12
96' Towers.....	13
Individual Tower Sections.....	14
Accessories.....	15
Replacement Parts.....	20
Concrete Foundation Details.....	23

## SuperTitan® Self-Support Towers.....25

Wind Load Capacity for TIA/EIA 222 Rev."G".....	26
20' Towers.....	27
30' Towers.....	28
40' Towers.....	29
50' Towers.....	30
60' Towers.....	32
70' Towers.....	34
80' Towers.....	36
90' Towers.....	38
100' Towers.....	40
110' Towers.....	42
120' Towers.....	44
130' Towers.....	46
140' Towers.....	48
150' Towers.....	50
160' Towers.....	52
170' Towers.....	53
180' Towers.....	54
190' Towers.....	55
Individual Tower Sections.....	56
Accessories.....	59
Replacement Parts.....	71
Anti-Climb Panel Installation.....	75
Concrete Foundation Details.....	76
Rapid Deployment Details.....	79

## SuperTitan® Max Towers .....83

Tower Comparison.....	84
-----------------------	----

Tower Profile.....	85
61' Towers.....	86
80' Towers.....	87
99' Towers.....	88
108' Towers.....	89
118' Towers.....	90
127' Towers.....	91
137' Towers.....	92
146' Towers.....	93
156' Towers.....	94
165' Towers.....	95
175' Towers.....	96
184' Towers.....	97
194' Towers.....	98
203' Towers.....	99
213' Towers.....	100
222' Towers.....	101
232' Towers.....	102
241' Towers.....	103
251' Towers.....	104
Accessories.....	105

## SuperTitan® Weld Towers ..... 107

20' Towers.....	109
30' Towers.....	110
40' Towers.....	111
50' Towers.....	112
60' Towers.....	114
70' Towers.....	116
80' Towers.....	118
90' Towers.....	120
100' Towers.....	122
110' Towers.....	124
120' Towers.....	126
130' Towers.....	128
40' Towers.....	129
150' Towers.....	130

## STG™ Tower Series ..... 133

STG vs Rohn Guyed.....	134
Tower Sections.....	135
STG Self-Support Complete Tower s / Foundations Details.....	136
STG Bracketed Complete Tower s / Foundations Details.....	137
STG Guyed Tower Kits.....	138
Concrete Foundation Details.....	145
Accessories.....	146
P.E. Stamped Drawings.....	152

## Notes

- All prices shown in this catalog are "Suggested List Prices" only, and are subject to change without notice.
- All prices shown in this catalog are in U.S. dollar funds.
- Any tower loading capacities stated in this Stocked Towers Catalog are based upon a maximum allowable antenna area being centrally located and balanced no more than 3' above the tower top. Addition of offset distances or other variations may result in a reduction of allowable antenna areas.
- Allowable antenna areas (sq.ft.) stated in this book for SuperTITAN SS towers are based on one (1) 1/2" coax line per 10 sq.ft. of round member antenna area placed at the tower top. If user has antenna placements below the tower top, or at wind speeds that do not correspond to the wind speeds in this book, they should contact Trylon TSF® or a Trylon TSF® Distributor to request a FREE TowerCalc™ analysis to determine the appropriate tower for the application.
- Readers are cautioned to understand the difference between wind load capacity based on "ANSI/TIA 222 F/G" standard and based on "Survival" standard. Some towers in this book provide maximum wind load ratings for both types. Prior to making any tower purchase, the user should first determine if their tower requirement calls for a "Survival" rating or an ANSI/TIA rating rev. F or G.
- In reference to wind load capacities, "--" means the tower model failed at that wind speed.

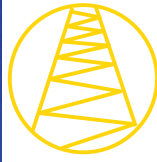

# TITAN<sup>®</sup>TOWER

SELF-SUPPORT

- .. Free-standing TITAN<sup>™</sup> Self-Support Towers need only minimal footprint area
- .. Heights ranging from 16 ft. to 96 ft.
- .. Lightweight, commercial-duty
- .. Ideal for ISP and SCADA
- .. Survives up to 100mph, depending on height and model

# Titan, the introductory level to the Stocked Tower family!

Total Height: 96'  
 Total Load: 15 sq ft\*



(\*70 mph Survival Wind Speed & 0" ice)

Total Height: 190'  
 Total Load: 10 sq ft\*

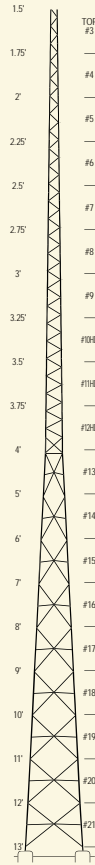

(\*90 mph EIA 222G Class 1 & 0.75" ice)

MAX Height: 251'  
 MAX Load: 62 sq ft\*

EL. = 251.00'  
 h-h = 2.50'

EL. = 241.00'  
 h-h = 2.76'

EL. = 222.00'  
 h-h = 3.25'

EL. = 203.00'  
 h-h = 3.75'

EL. = 190.00'  
 h-h = 4.00'

EL. = 171.00'  
 h-h = 6.00'

EL. = 152.00'  
 h-h = 8.00'

EL. = 133.00'  
 h-h = 10.00'

EL. = 114.00'  
 h-h = 12.00'

EL. = 95.00'  
 h-h = 14.00'

EL. = 76.00'  
 h-h = 16.00'

EL. = 57.00'  
 h-h = 18.00'

EL. = 38.00'  
 h-h = 20.00'

EL. = 19.00'  
 h-h = 22.00'

EL. = 0'  
 h-h = 24.00'

(\*90 mph EIA 222G Class 2 & 0.75" ice)



- Survival tower
- Not compliant to EIA 222 F and G
- Stocked and sold through distribution
- Ship assembled in 8' sections
- Max face width: 45 inches
- P.E. stamp **not** available
- Model shown: 96' T200

- EIA 222 F and G compliant, Stocked and sold through distribution
- Ship knocked-down (unassembled) in 10' sections
- Max face width: 13 feet
- P.E. stamp available
- Model shown: 190' S310

- EIA 222 F and G compliant, Ships directly from Trylon
- Ship knocked-down (unassembled) in 19' sections
- Max face width: 24 feet
- P.E. stamp available
- Model shown: 251' M300



# 16' Towers



Model Designation:		T200	T300	T400	T500	T600	T700	T800
Part Number:		4.95.0201.000	4.95.0301.000	4.95.0401.000	4.95.0501.000	4.95.0601.000	4.95.0701.000	4.95.0801.000
Includes 4' anchor stub legs for concrete, splice hardware, 8' antenna mounting pipe, angle frames, and u-bolt assembly in top section.								
Allowable antenna area in ft <sup>2</sup> at 70/85/100 mph wind*	Survival no ice	Round: 16/9/4 Flat: 11/6/3	Round: 28/16/9 Flat: 19/11/6	Round: 39/24/15 Flat: 26/16/10	Round: 64/41/27 Flat: 43/27/18	Round: 87/55/36 Flat: 58/36/24	Round: 108/69/47 Flat: 72/46/31	Round: 132/86/58 Flat: 88/57/38
	Survival 1/2" ice	Round: 2/--/-- Flat: 1/--/--	Round: 3/--/-- Flat: 2/--/--	Round: 10/--/-- Flat: 6/--/--	Round: 24/1/-- Flat: 16/1/--	Round: 36/6/-- Flat: 24/4/--	Round: 60/18/2 Flat: 45/12/1	Round: 80/32/6 Flat: 53/21/4
Shipping Dimensions (L"xW"xH")		101x40x17	101x40x20	101x40x22	101x40x26	101x40x32	101x50x36	101x60x38
Shipping Weight (lbs)		189	210	233	264	294	320	363

\*Based on the antenna load being centrally located and balanced 3' or less above the tower top ("--" indicates tower failure). Titan towers' wind loads are based on survival design and cannot be P.E. stamped.  
\*Round antennas include omnis, dipoles, dishes with radomes, etc. Antennas where wind hits a round surface. Flat Antennas include flat panels, dishes without radomes and cameras, where wind hits a flat surface.

## Common Accessories

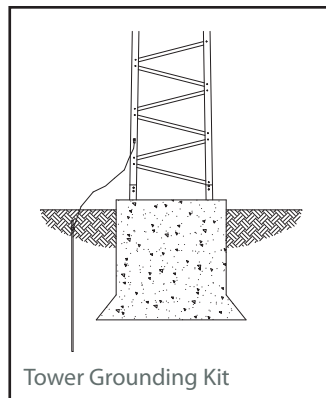
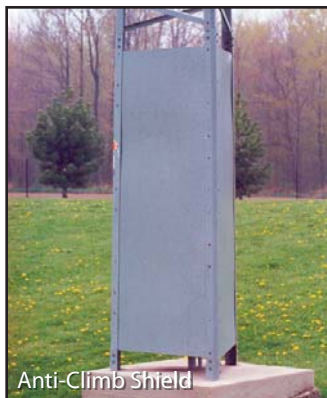

Accessory:	T200	T300	T400	T500	T600	T700	T800
<b>Anti-Climb Shield</b> set of 3	N/A	4.92.0104.000	4.92.0105.000	4.92.0106.000	4.92.0107.000	4.92.0108.000	4.92.0109.000
<b>Tower Grounding Kit</b> with #6 copper wire	4.91.0101.000	4.91.0101.000	4.91.0101.000	4.91.0101.000	4.91.0101.000	4.91.0101.000	4.91.0101.000
<b>Side Mount (Top Section)</b> with 2 angle frames, clip angles, u-bolt assemblies, and 6' pipe	4.84.1141.000	4.84.1142.000	4.84.1151.000	4.84.1152.000	4.84.1161.000	4.84.1162.000	4.84.1171.000
For more Antenna Side Mount Kits, see accessories page 16.							
<b>Base Foot Weldments</b> set of 3	4.82.0104.000	4.82.0105.000	4.82.0106.000	4.82.0107.000	4.82.0108.000	4.82.0109.000	4.82.0110.000
<b>Lighting Kits</b> with cable	4.93.0102.000	4.93.0102.000	4.93.0102.000	4.93.0102.000	4.93.0102.000	4.93.0102.000	4.93.0102.000

For more TITAN Accessories and Replacement Parts, see pages 15 to 22.

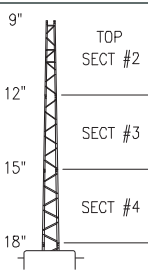
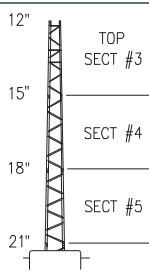
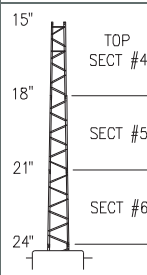
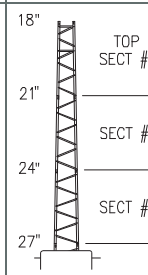
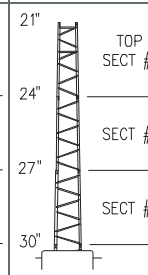
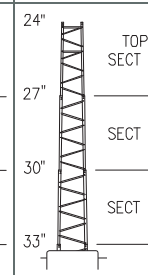
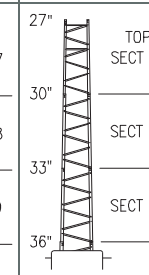

Model Designation:		T200	T300	T400	T500	T600	T700	T800
Part Number:		4.95.0202.000	4.95.0302.000	4.95.0402.000	4.95.0502.000	4.95.0602.000	4.95.0702.000	4.95.0802.000
Includes 4' anchor stub legs for concrete, splice hardware, 8' antenna mounting pipe, angle frames, and u-bolt assembly in top section.								
Allowable antenna area in ft <sup>2</sup> at 70/85/100 mph wind*	Survival no ice	Round: 16/8/3 Flat: 11/6/2	Round: 24/12/5 Flat: 16/8/3	Round: 39/23/14 Flat: 26/15/9	Round: 60/36/21 Flat: 40/24/14	Round: 76/46/29 Flat: 51/31/19	Round: 94/58/37 Flat: 63/38/24	Round: 131/85/57 Flat: 88/56/38
	Survival 1/2" ice	Round: 2/--/-- Flat: 1/--/--	Round: 3/--/-- Flat: 2/--/--	Round: 10/--/-- Flat: 6/--/--	Round: 24/1/-- Flat: 16/1/--	Round: 36/6/-- Flat: 24/4/--	Round: 60/18/2 Flat: 45/12/1	Round: 80/32/6 Flat: 53/21/4
Shipping Dimensions (LxWxH")		101x40x20	101x40x22	101x40x26	101x48x32	101x50x36	101x60x38	101x60x40
Shipping Weight (lbs)		234	259	302	340	379	433	516

\*Based on the antenna load being centrally located and balanced 3' or less above the tower top ("--" indicates tower failure). Titan towers' wind loads are based on survival design and cannot be P.E. stamped. Round antennas include omnis, dipoles, dishes with radomes, etc. Antennas where wind hits a round surface. Flat Antennas include flat panels, dishes without radomes and cameras, where wind hits a flat surface.

## Common Accessories

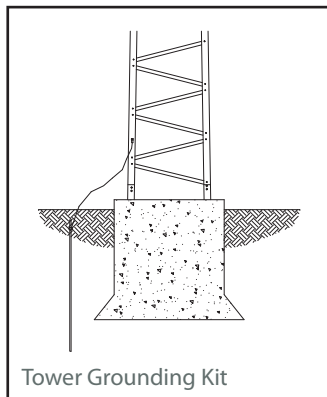

Accessory:	T200	T300	T400	T500	T600	T700	T800
<b>Anti-Climb Shield</b> set of 3	4.92.0104.000	4.92.0105.000	4.92.0106.000	4.92.0107.000	4.92.0108.000	4.92.0109.000	4.92.0110.000
<b>Tower Grounding Kit</b> with #6 copper wire	4.91.0101.000	4.91.0101.000	4.91.0101.000	4.91.0101.000	4.91.0101.000	4.91.0101.000	4.91.0101.000
<b>Side Mount (Top Section)</b> with 2 angle frames, clip angles, u-bolt assemblies, and 6" pipe	4.84.1141.000	4.84.1142.000	4.84.1151.000	4.84.1152.000	4.84.1161.000	4.84.1162.000	4.84.1171.000
<i>For more Antenna Side Mount Kits, see accessories page 16.</i>							
<b>Base Foot Weldments</b> set of 3	4.82.0105.000	4.82.0106.000	4.82.0107.000	4.82.0108.000	4.82.0109.000	4.82.0110.000	4.82.0111.000
<b>Lighting Kits</b> with cable	4.93.0103.000	4.93.0103.000	4.93.0103.000	4.93.0103.000	4.93.0103.000	4.93.0103.000	4.93.0103.000

For more TITAN Accessories and Replacement Parts, see pages 15 to 22.

# 32' Towers



Model Designation:		T200	T300	T400	T500	T600	T700	T800
Part Number:		4.95.0203.000	4.95.0303.000	4.95.0403.000	4.95.0503.000	4.95.0603.000	4.95.0703.000	4.95.0803.000
<p>Includes 4' anchor stub legs for concrete, splice hardware, 8' x 1.9"OD antenna mounting pipe.</p> <p>Tower height shown is nominal. Actual tower height is achieved using support pipe provided with tower.</p>								
Allowable antenna area in ft <sup>2</sup> at 70/85/100 mph wind*	Survival no ice	Round: 16/6/-- Flat: 10/4/--	Round: 24/13/6 Flat: 16/9/4	Round: 39/24/12 Flat: 26/16/8	Round: 56/32/17 Flat: 38/21/11	Round: 70/40/23 Flat: 47/27/15	Round: 95/59/37 Flat: 63/39/25	Round: 132/86/57 Flat: 88/57/38
	Survival 1/2" ice	Round: 2/--/-- Flat: 1/--/--	Round: 3/--/-- Flat: 2/--/--	Round: 10/--/-- Flat: 6/--/--	Round: 24/1/-- Flat: 16/1/--	Round: 36/6/-- Flat: 24/4/--	Round: 60/18/2 Flat: 45/12/1	Round: 80/32/6 Flat: 53/21/4
Shipping Dimensions (L"xW"xH")		101x40x22	101x40x26	101x48x32	101x50x36	101x60x38	101x60x40	101x64x42
Shipping Weight (lbs)		283	328	377	425	493	587	675

\*Based on the antenna load being centrally located and balanced 3' or less above the tower top ("--" indicates tower failure). Titan towers' wind loads are based on survival design and cannot be P.E. stamped.  
 \*Round antennas include omnis, dipoles, dishes with radomes, etc. Antennas where wind hits a round surface. Flat Antennas include flat panels, dishes without radomes and cameras, where wind hits a flat surface.

## Common Accessories

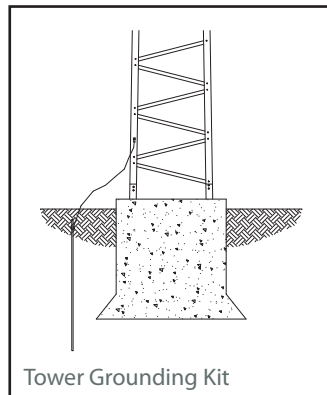
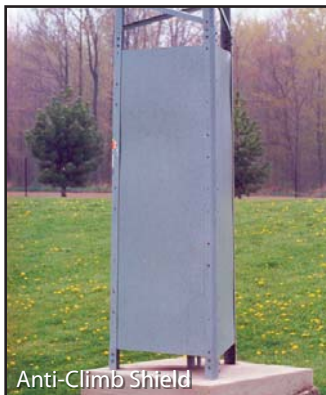

Accessory:	T200	T300	T400	T500	T600	T700	T800
<b>Anti-Climb Shield</b> <i>set of 3</i>	4.92.0105.000	4.92.0106.000	4.92.0107.000	4.92.0108.000	4.92.0109.000	4.92.0110.000	4.92.0111.000
<b>Tower Grounding Kit</b> <i>with #6 copper wire</i>	4.91.0101.000	4.91.0101.000	4.91.0101.000	4.91.0101.000	4.91.0101.000	4.91.0101.000	4.91.0101.000
<b>Side Mount (Top Section)</b> <i>with 2 angle frames, clip angles, u-bolt assemblies, and 6' pipe</i>	4.84.1141.000	4.84.1142.000	4.84.1151.000	4.84.1152.000	4.84.1161.000	4.84.1162.000	4.84.1171.000
<i>For more Antenna Side Mount Kits, see accessories page 16.</i>							
<b>Base Foot Weldments</b> <i>set of 3</i>	4.82.0106.000	4.82.0107.000	4.82.0108.000	4.82.0109.000	4.82.0110.000	4.82.0111.000	4.82.0112.000

For more TITAN Accessories and Replacement Parts, see pages 15 to 22.



Model Designation:		T200	T300	T400	T500	T600	T700	T800
Part Number:		4.95.0204.000	4.95.0304.000	4.95.0404.000	4.95.0504.000	4.95.0604.000	4.95.0704.000	4.95.0804.000
Includes 4' anchor stub legs for concrete, splice hardware, 8' x 1.9"OD antenna mounting pipe.  Tower height shown is nominal. Actual tower height is achieved using support pipe provided with tower.								
Allowable antenna area in ft <sup>2</sup> at 70/85/100 mph wind*	Survival no ice	Round: 16/6/-- Flat: 10/4/--	Round: 25/13/4 Flat: 17/9/3	Round: 40/20/8 Flat: 27/14/5	Round: 52/27/12 Flat: 35/18/8	Round: 70/40/23 Flat: 47/27/15	Round: 95/59/37 Flat: 64/39/25	Round: 132/79/47 Flat: 88/53/32
	Survival 1/2" ice	Round: 2/--/-- Flat: 1/--/--	Round: 3/--/-- Flat: 2/--/--	Round: 10/--/-- Flat: 6/--/--	Round: 24/1/-- Flat: 16/1/--	Round: 36/6/-- Flat: 24/4/--	Round: 60/18/2 Flat: 45/12/1	Round: 80/32/6 Flat: 53/21/4
Shipping Dimensions (L"xW"xH")		101x40x26	101x48x32	101x50x36	101x60x38	101x60x40	101x64x42	101x67x45
Shipping Weight (lbs)		352	403	463	538	647	743	833

\*Based on the antenna load being centrally located and balanced 3' or less above the tower top ("--" indicates tower failure). Titan towers' wind loads are based on survival design and cannot be P.E. stamped. Round antennas include omnis, dipoles, dishes with radomes, etc. Antennas where wind hits a round surface. Flat Antennas include flat panels, dishes without radomes and cameras, where wind hits a flat surface.

## Common Accessories

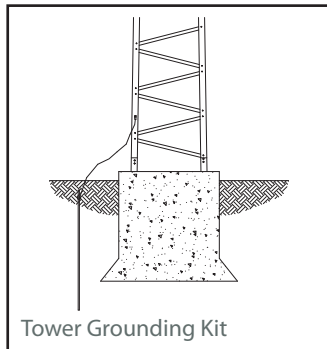
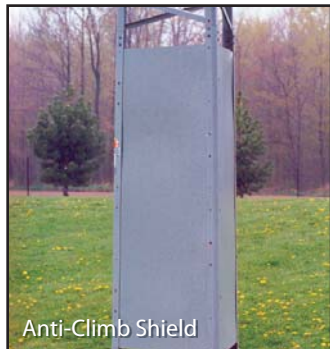

Accessory:	T200	T300	T400	T500	T600	T700	T800
<b>Anti-Climb Shield</b> set of 3	4.92.0106.000	4.92.0107.000	4.92.0108.000	4.92.0109.000	4.92.0110.000	4.92.0111.000	4.92.0112.000
<b>Tower Grounding Kit</b> with #6 copper wire	4.91.0101.000	4.91.0101.000	4.91.0101.000	4.91.0101.000	4.91.0101.000	4.91.0101.000	4.91.0101.000
<b>Side Mount (Top Section)</b> with 2 angle frames, clip angles, u-bolt assemblies, and 6" pipe	4.84.1141.000	4.84.1142.000	4.84.1151.000	4.84.1152.000	4.84.1161.000	4.84.1162.000	4.84.1171.000
<i>For more Antenna Side Mount Kits, see accessories page 16.</i>							
<b>Base Foot Weldments</b> set of 3	4.82.0107.000	4.82.0108.000	4.82.0109.000	4.82.0110.000	4.82.0111.000	4.82.0112.000	4.82.0113.000

For more TITAN Accessories and Replacement Parts, see pages 15 to 22.

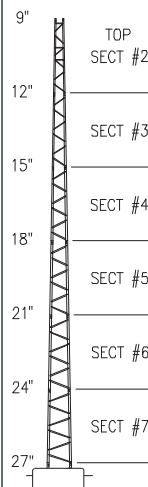
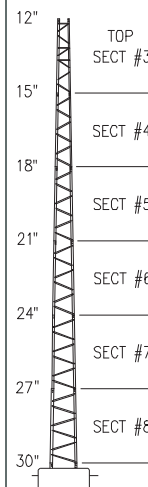
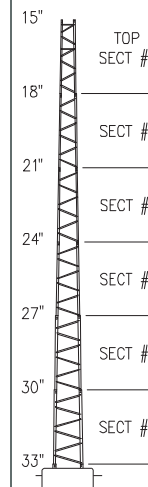
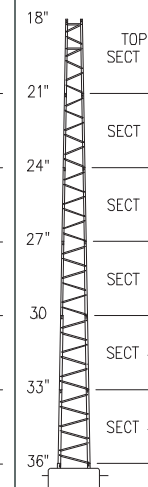
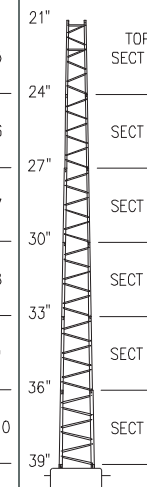
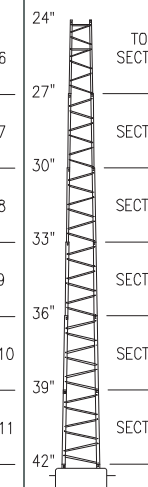
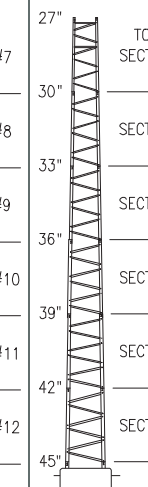

Model Designation:		T200	T300	T400	T500	T600	T700	T800
Part Number:		4.95.0205.000	4.95.0305.000	4.95.0405.000	4.95.0505.000	4.95.0605.000	4.95.0705.000	4.95.0805.000
<p>Includes 4' anchor stub legs for concrete, splice hardware, 8' x 1.9"OD antenna mounting pipe.</p> <p>Tower height shown is nominal. Actual tower height is achieved using support pipe provided with tower.</p>								
Allowable antenna area in ft <sup>2</sup> at 70/85/100 mph wind*	Survival no ice	Round: 16/6/-- Flat: 10/4/--	Round: 25/11/1 Flat: 17/8/1	Round: 37/17/4 Flat: 25/11/3	Round: 50/27/12 Flat: 34/18/8	Round: 67/40/23 Flat: 45/27/15	Round: 95/59/32 Flat: 64/39/21	Round: 126/72/40 Flat: 84/48/27
	Survival 1/2" ice	Round: 2/--/-- Flat: 1/--/--	Round: 3/--/-- Flat: 2/--/--	Round: 10/--/-- Flat: 6/--/--	Round: 24/1/-- Flat: 16/1/--	Round: 36/6/-- Flat: 24/4/--	Round: 60/18/2 Flat: 45/12/1	Round: 80/32/6 Flat: 53/21/4
Shipping Dimensions (L"xW"xH")		101x48x32	101x50x36	101x60x38	101x60x40	101x64x42	101x67x45	101x75x49
Shipping Weight (lbs)		427	489	577	692	803	904	1,044

\*Based on the antenna load being centrally located and balanced 3' or less above the tower top ("--" indicates tower failure). Titan towers' wind loads are based on survival design and cannot be P.E. stamped.  
\*Round antennas include omnis, dipoles, dishes with radomes, etc. Antennas where wind hits a round surface. Flat Antennas include flat panels, dishes without radomes and cameras, where wind hits a flat surface.

## Common Accessories

Accessory:	T200	T300	T400	T500	T600	T700	T800
<b>Anti-Climb Shield</b> <i>set of 3</i>	4.92.0107.000	4.92.0108.000	4.92.0109.000	4.92.0110.000	4.92.0111.000	4.92.0112.000	4.92.0113.000
<b>Tower Grounding Kit</b> <i>with #6 copper wire</i>	4.91.0101.000	4.91.0101.000	4.91.0101.000	4.91.0101.000	4.91.0101.000	4.91.0101.000	4.91.0101.000
<b>Side Mount (Top Section)</b> <i>with 2 angle frames, clip angles, u-bolt assemblies, and 6' pipe</i>	4.84.1141.000	4.84.1142.000	4.84.1151.000	4.84.1152.000	4.84.1161.000	4.84.1162.000	4.84.1171.000
<i>For more Antenna Side Mount Kits, see accessories page 16.</i>							
<b>Base Foot Weldments</b> <i>set of 3</i>	4.82.0108.000	4.82.0109.000	4.82.0110.000	4.82.0111.000	4.82.0112.000	4.82.0113.000	4.82.0114.000
<b>Lighting Kits</b> <i>with cable</i>	4.93.0106.000	4.93.0106.000	4.93.0106.000	4.93.0106.000	4.93.0106.000	4.93.0106.000	4.93.0106.000

For more TITAN Accessories and Replacement Parts, see pages 15 to 22.

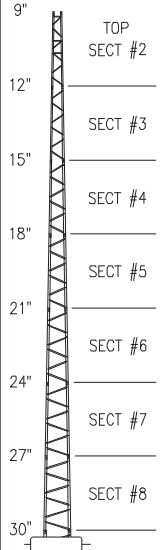
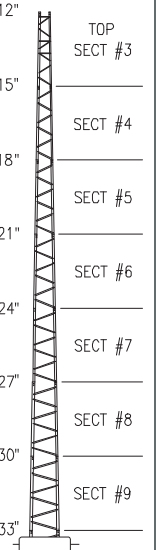
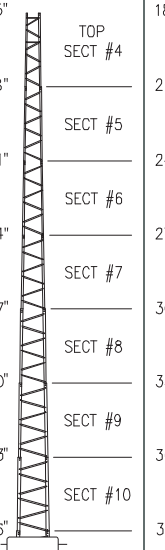
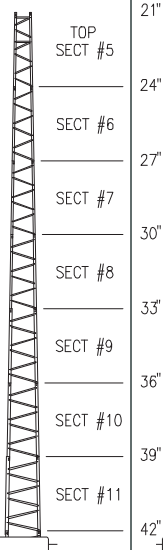
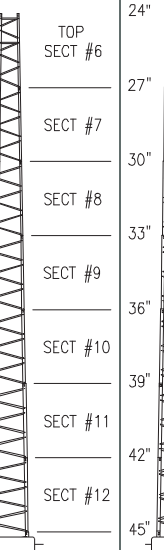
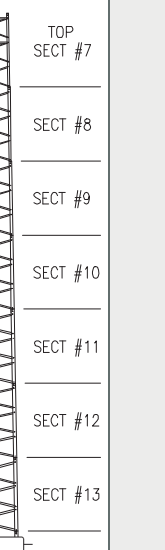
Model Designation:		T200	T300	T400	T500	T600	T700
Part Number:		4.95.0206.000	4.95.0306.000	4.95.0406.000	4.95.0506.000	4.95.0606.000	4.95.0706.000
<p>Includes 4' anchor stub legs for concrete, splice hardware, 8' x 1.9"OD antenna mounting pipe.</p> <p>Tower height shown is nominal. Actual tower height is achieved using support pipe provided with tower.</p>							
Allowable antenna area in ft <sup>2</sup> at 70/85/100 mph wind*	Survival no ice	Round: 16/5/-- Flat: 10/3/--	Round: 25/9/-- Flat: 17/6/--	Round: 38/17/4 Flat: 26/11/3	Round: 52/27/12 Flat: 35/18/8	Round: 70/40/20 Flat: 47/27/13	Round: 95/54/26 Flat: 64/36/17
	Survival 1/2" ice	Round: 2/--/-- Flat: 1/--/--	Round: 3/--/-- Flat: 2/--/--	Round: 10/--/-- Flat: 6/--/--	Round: 24/1/-- Flat: 16/1/--	Round: 36/6/-- Flat: 24/4/--	Round: 60/18/2 Flat: 45/12/1
Shipping Dimensions (L"xW"xH")		101x50x36	101x60x38	101x60x40	101x64x42	101x67x45	101x75x49
Shipping Weight (lbs)		513	602	730	848	964	1,115

\*Based on the antenna load being centrally located and balanced 3' or less above the tower top ("--" indicates tower failure). Titan towers' wind loads are based on survival design and cannot be P.E. stamped.  
\*Round antennas include omnis, dipoles, dishes with radomes, etc. Antennas where wind hits a round surface. Flat Antennas include flat panels, dishes without radomes and cameras, where wind hits a flat surface.

## Common Accessories

Accessory:	T200	T300	T400	T500	T600	T700
<b>Anti-Climb Shield</b> <i>set of 3</i>	4.92.0108.000	4.92.0109.000	4.92.0110.000	4.92.0111.000	4.92.0112.000	4.92.0113.000
<b>Tower Grounding Kit</b> <i>with #6 copper wire</i>	4.91.0101.000	4.91.0101.000	4.91.0101.000	4.91.0101.000	4.91.0101.000	4.91.0101.000
<b>Side Mount (Top Section)</b> <i>with 2 angle frames, clip angles, u-bolt assemblies, and 6' pipe</i>	4.84.1141.000	4.84.1142.000	4.84.1151.000	4.84.1152.000	4.84.1161.000	4.84.1162.000
<i>For more Antenna Side Mount Kits, see accessories page 16.</i>						
<b>Base Foot Weldments</b> <i>set of 3</i>	4.82.0109.000	4.82.0110.000	4.82.0111.000	4.82.0112.000	4.82.0113.000	4.82.0114.000
<b>Lighting Kits</b> <i>with cable</i>	4.93.0107.000	4.93.0107.000	4.93.0107.000	4.93.0107.000	4.93.0107.000	4.93.0107.000

For more TITAN Accessories and Replacement Parts, see pages 15 to 22.

Model Designation:		T200	T300	T400	T500	T600		
Part Number:		4.95.0207.000	4.95.0307.000	4.95.0407.000	4.95.0507.000	4.95.0607.000		
<p>Includes 4' anchor stub legs for concrete, splice hardware, 8' x 1.9"OD antenna mounting pipe.</p> <p>To support the mounting pipe, every top section is factory installed with angle frames and u-bolts at top and middle of the section.</p> <p>Tower height shown is nominal. Actual tower height is achieved using support pipe provided with tower.</p>								
Allowable antenna area in ft <sup>2</sup> at 70/85/100 mph wind*	Survival no ice	Round: 16/3/-- Flat: 10/2/--	Round: 25/9/-- Flat: 17/6/--	Round: 39/17/4 Flat: 26/11/3	Round: 52/27/10 Flat: 35/18/7	Round: 70/40/15 Flat: 47/27/10		
	Survival 1/2" ice	Round: 2/--/-- Flat: 1/--/--	Round: 3/--/-- Flat: 2/--/--	Round: 10/--/-- Flat: 6/--/--	Round: 24/1/-- Flat: 16/1/--	Round: 36/6/-- Flat: 24/4/--		
Shipping Dimensions (L"xW"xH")		101x60x38	101x60x40	101x64x42	101x67x45	101x75x49		
Shipping Weight (lbs)		627	756	886	1,009	1,174		

\*Based on the antenna load being centrally located and balanced 3' or less above the tower top ("--" indicates tower failure). Titan towers' wind loads are based on survival design and cannot be P.E. stamped.  
 \*Round antennas include omnis, dipoles, dishes with radomes, etc. Antennas where wind hits a round surface. Flat Antennas include flat panels, dishes without radomes and cameras, where wind hits a flat surface.

## Common Accessories

Accessory:	T200	T300	T400	T500	T600		
<b>Anti-Climb Shield</b> <i>set of 3</i>	4.92.0109.000	4.92.0110.000	4.92.0111.000	4.92.0112.000	4.92.0113.000		
<b>Tower Grounding Kit</b> <i>with #6 copper wire</i>	4.91.0101.000	4.91.0101.000	4.91.0101.000	4.91.0101.000	4.91.0101.000		
<b>Side Mount (Top Section)</b> <i>with 2 angle frames, clip angles, u-bolt assemblies, and 6' pipe</i>	4.84.1141.000	4.84.1142.000	4.84.1151.000	4.84.1152.000	4.84.1161.000		
<i>For more Antenna Side Mount Kits, see accessories page 16.</i>							
<b>Base Foot Weldments</b> <i>set of 3</i>	4.82.0110.000	4.82.0111.000	4.82.0112.000	4.82.0113.000	4.82.0114.000		

For more TITAN Accessories and Replacement Parts, see pages 15 to 22.

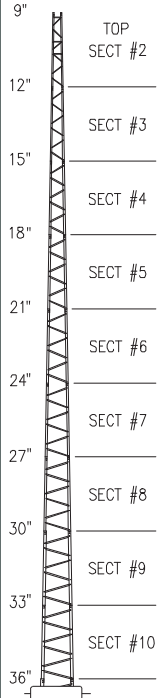
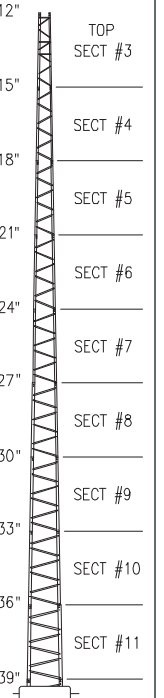
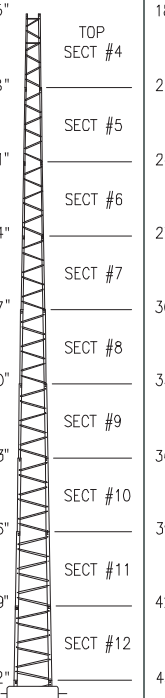
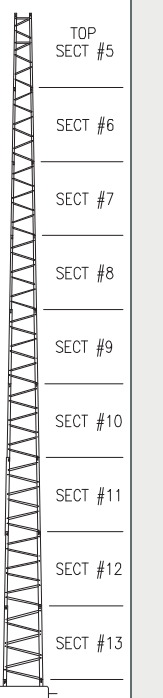
Model Designation:		T200	T300	T400	T500			
Part Number:		4.95.0208.000	4.95.0308.000	4.95.0408.000	4.95.0508.000			
<p>Includes 4' anchor stub legs for concrete, splice hardware, 8' x 1.9"OD antenna mounting pipe.</p> <p>To support the mounting pipe, every top section is factory installed with angle frames and u-bolts at top and middle of the section.</p> <p>Tower height shown is nominal. Actual tower height is achieved using support pipe provided with tower.</p>								
Allowable antenna area in ft <sup>2</sup> at 70/85/100 mph wind*	Survival no ice	Round: 16/3/-- Flat: 10/2/--	Round: 25/9/-- Flat: 17/6/--	Round: 39/17/3 Flat: 26/11/9	Round: 45/22/6 Flat: 34/18/4			
	Survival 1/2" ice	Round: 2/--/-- Flat: 1/--/--	Round: 3/--/-- Flat: 2/--/--	Round: 10/--/-- Flat: 6/--/--	Round: 24/1/-- Flat: 16/1/--			
Shipping Dimensions (L"xW"xH")		101x60x40	101x64x42	101x67x45	101x75x49			
Shipping Weight (lbs)		780	912	1,047	1,220			

\*Based on the antenna load being centrally located and balanced 3' or less above the tower top ("--" indicates tower failure). Titan towers' wind loads are based on survival design and cannot be P.E. stamped. \*Round antennas include omnis, dipoles, dishes with radomes, etc. Antennas where wind hits a round surface. Flat Antennas include flat panels, dishes without radomes and cameras, where wind hits a flat surface.

## Common Accessories

Accessory:	T200	T300	T400	T500			
<b>Anti-Climb Shield</b> set of 3	4.92.0110.000	4.92.0111.000	4.92.0112.000	4.92.0113.000			
<b>Tower Grounding Kit</b> with #6 copper wire	4.91.0101.000	4.91.0101.000	4.91.0101.000	4.91.0101.000			
<b>Side Mount (Top Section)</b> with 2 angle frames, clip angles, u-bolt assemblies, and 6' pipe	4.84.1141.000	4.84.1142.000	4.84.1151.000	4.84.1152.000			
For more Antenna Side Mount Kits, see accessories page 16.							
<b>Base Foot Weldments</b> set of 3	4.82.0111.000	4.82.0112.000	4.82.0113.000	4.82.0114.000			

For more TITAN Accessories and Replacement Parts, see pages 15 to 22.



# 80' Towers



Model Designation:		T200	T300	T400				
Part Number:		4.95.0209.000	4.95.0309.000	4.95.0409.000				
<p>Includes 4' anchor stub legs for concrete, splice hardware, 8' x 1.9"OD antenna mounting pipe.</p> <p>To support the mounting pipe, every top section is factory installed with angle frames and u-bolts at top and middle of the section.</p> <p>Tower height shown is nominal. Actual tower height is achieved using support pipe provided with tower.</p>								
Allowable antenna area in ft <sup>2</sup> at 70/85/100 mph wind*	Survival no ice	Round: 15/2/-- Flat: 10/2/--	Round: 25/9/-- Flat: 17/6/--	Round: 39/17/1 Flat: 26/11/1				
	Survival 1/2" ice	Round: 2/--/-- Flat: 1/--/--	Round: 3/--/-- Flat: 2/--/--	Round: 10/--/-- Flat: 6/--/--				
Shipping Dimensions (L"xW"xH")		101x64x42	101x67x45	101x75x49				
Shipping Weight (lbs)		936	1,073	1,258				

\*Based on the antenna load being centrally located and balanced 3' or less above the tower top ("--" indicates tower failure). Titan towers' wind loads are based on survival design and cannot be P.E. stamped.  
 \*Round antennas include omnis, dipoles, dishes with radomes, etc. Antennas where wind hits a round surface. Flat Antennas include flat panels, dishes without radomes and cameras, where wind hits a flat surface.

## Common Accessories

Accessory:	T200	T300	T400			
<b>Anti-Climb Shield</b> set of 3	4.92.0111.000	4.92.0112.000	4.92.0113.000			
<b>Tower Grounding Kit</b> with #6 copper wire	4.91.0101.000	4.91.0101.000	4.91.0101.000			
<b>Side Mount (Top Section)</b> with 2 angle frames, clip angles, u-bolt assemblies, and 6' pipe	4.84.1141.000	4.84.1142.000	4.84.1151.000			
For more Antenna Side Mount Kits, see accessories page 16.						

For more TITAN Accessories and Replacement Parts, see pages 15 to 22.

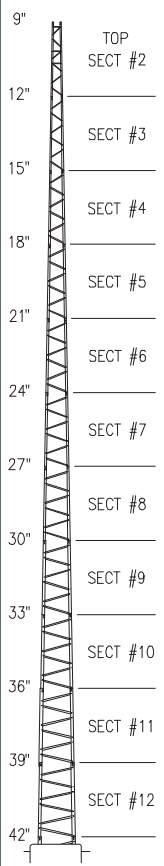
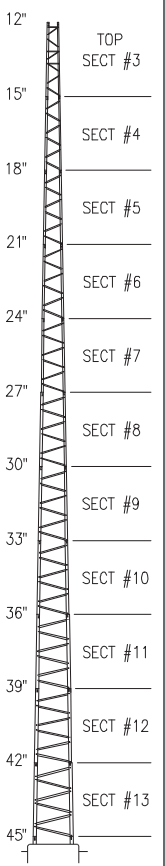
Model Designation:		T200	T300				
Part Number:		4.95.0210.000	4.95.0310.000				
<p>Includes 4' anchor stub legs for concrete, splice hardware, 8' x 1.9"OD antenna mounting pipe.</p> <p>To support the mounting pipe, every top section is factory installed with angle frames and u-bolts at top and middle of the section.</p> <p>Tower height shown is nominal. Actual tower height is achieved using support pipe provided with tower.</p>		 <p>9" TOP SECT #2</p> <p>12" SECT #3</p> <p>15" SECT #4</p> <p>18" SECT #5</p> <p>21" SECT #6</p> <p>24" SECT #7</p> <p>27" SECT #8</p> <p>30" SECT #9</p> <p>33" SECT #10</p> <p>36" SECT #11</p> <p>39" SECT #12</p> <p>42" SECT #12</p>	 <p>12" TOP SECT #3</p> <p>15" SECT #4</p> <p>18" SECT #5</p> <p>21" SECT #6</p> <p>24" SECT #7</p> <p>27" SECT #8</p> <p>30" SECT #9</p> <p>33" SECT #10</p> <p>36" SECT #11</p> <p>39" SECT #12</p> <p>42" SECT #12</p> <p>45" SECT #13</p>				
Allowable antenna area in ft <sup>2</sup> at 70/85/100 mph wind*	Survival no ice	Round: 16/3/-- Flat: 10/2/--	Round: 22/6/-- Flat: 15/4/--				
	Survival 1/2" ice	Round: 2/--/-- Flat: 1/--/--	Round: 3/--/-- Flat: 2/--/--				
Shipping Dimensions (L"xW"xH")		101x67x45	101x75x49				
Shipping Weight (lbs)		1,098	1,284				

\*Based on the antenna load being centrally located and balanced 3' or less above the tower top ("--" indicates tower failure). Titan towers' wind loads are based on survival design and cannot be P.E. stamped. \*Round antennas include omnis, dipoles, dishes with radomes, etc. Antennas where wind hits a round surface. Flat Antennas include flat panels, dishes without radomes and cameras, where wind hits a flat surface.

## Common Accessories

Accessory:	T200	T300				
<b>Anti-Climb Shield</b> set of 3	4.92.0112.000	4.92.0113.000				
<b>Tower Grounding Kit</b> with #6 copper wire	4.91.0101.000	4.91.0101.000				

For more TITAN Accessories and Replacement Parts, see pages 15 to 22.

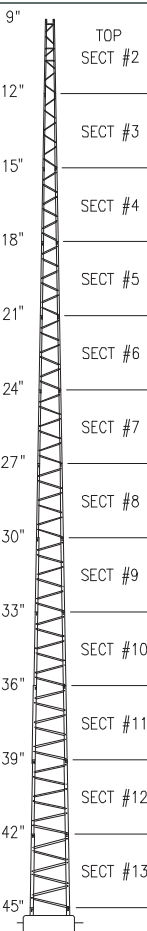
Model Designation:		T200					
Part Number:		4.95.0211.000					
Includes 4' anchor stub legs for concrete, splice hardware, 8' x 1.9"OD antenna mounting pipe.  Tower height shown is nominal. Actual tower height is achieved using support pipe provided with tower.							
Allowable antenna area in ft <sup>2</sup> at 70/85/100 mph wind*	Survival no ice	Round: 15/3/-- Flat: 10/2/--					
	Survival 1/2" ice	Round: 2/--/-- Flat: 1/--/--					
Shipping Dimensions (L"xW"xH")		101x75x49					
Shipping Weight (lbs)		1,308					

\*Based on the antenna load being centrally located and balanced 3' or less above the tower top ("--" indicates tower failure). Titan towers' wind loads are based on survival design and cannot be P.E. stamped.  
 \*Round antennas include omnis, dipoles, dishes with radomes, etc. Antennas where wind hits a round surface. Flat Antennas include flat panels, dishes without radomes and cameras, where wind hits a flat surface.

## Common Accessories

Accessory:	T200					
<b>Anti-Climb Shield</b> <i>set of 3</i>	4.92.0113.000					
<b>Tower Grounding Kit</b> <i>with #6 copper wire</i>	4.91.0101.000					

For more TITAN Accessories and Replacement Parts, see pages 15 to 22.

# TITAN<sup>®</sup> TOWER SELF-SUPPORT Individual Tower Sections

## Pre-Assembled 8' Sections (with Splice Hardware to mate with next section)

Part Number	Description	Bare Wt. (lbs)	Ship LxWxH (in)	Image
4.95.0022.000	Tower section # 2 Top c/w hot-dip galv. 1.9"OD x 8' pipe	35	101x40x22	
4.95.0031.000	Tower section # 3	30	101x40x25	
4.95.0032.000	Tower section # 3 Top c/w hot-dip galv. 1.9"OD x 8' pipe	40	101x40x25	
4.95.0041.000	Tower section # 4	38	101x40x28	
4.95.0042.000	Tower section # 4 Top c/w hot-dip galv. 1.9"OD x 8' pipe	53	101x40x28	
4.95.0051.000	Tower section # 5	44	101x40x31	
4.95.0052.000	Tower section # 5 Top c/w hot-dip galv. 1.9"OD x 8' pipe	59	101x40x31	
4.95.0061.000	Tower section # 6	58	101x40x34	
4.95.0062.000	Tower section # 6 Top c/w hot-dip galv. 1.9"OD x 8' pipe	85	101x40x34	
4.95.0071.000	Tower section # 7	71	101x40x37	
4.95.0072.000	Tower section # 7 Top c/w hot-dip galv. 1.9"OD x 8' pipe	91	101x40x37	
4.95.0081.000	Tower section # 8	78	101x40x40	
4.95.0082.000	Tower section # 8 Top c/w hot-dip galv. 1.9"OD x 8' pipe	110	101x40x40	
4.95.0091.000	Tower section # 9	107	101x48x43	
4.95.0101.000	Tower section #10	133	101x48x46	
4.95.0111.000	Tower section #11	148	101x48x49	
4.95.0121.000	Tower section #12	160	101x48x52	
4.95.0131.000	Tower section #13	190	101x48x55	

## Anchor Stub Legs - Set of 3 (4' long, for concrete foundations)

Part Number	Description	Ship Wt. (lbs)	Ship LxWxH (in)	Image
4.81.0104.000	Anchor Stub Leg # 4 - fits section # 3	10	48x6x6	
4.81.0105.000	Anchor Stub Leg # 5 - fits section # 4	13	48x6x6	
4.81.0106.000	Anchor Stub Leg # 6 - fits section # 5	16	48x6x6	
4.81.0107.000	Anchor Stub Leg # 7 - fits section # 6	21	48x6x6	
4.81.0108.000	Anchor Stub Leg # 8 - fits section # 7	25	48x6x6	
4.81.0109.000	Anchor Stub Leg # 9 - fits section # 8	28	48x6x6	
4.81.0110.000	Anchor Stub Leg #10 - fits section # 9	40	48x6x6	
4.81.0111.000	Anchor Stub Leg #11 - fits section #10	48	48x6x6	
4.81.0112.000	Anchor Stub Leg #12 - fits section #11	58	48x6x6	
4.81.0113.000	Anchor Stub Leg #13 - fits section #12	75	48x6x6	
4.81.0114.000	Anchor Stub Leg #14 - fits section #13	80	48x6x6	

## 4' Short Foundation Sections (for embedment in concrete; alternate to anchor stub legs)

Part Number	Description	Ship Wt. (lbs)	Ship LxWxH (in)	Image
4.81.0204.000	4' Foundation section - fits section # 3	15	48x48x21	
4.81.0205.000	4' Foundation section - fits section # 4	19	48x48x24	
4.81.0206.000	4' Foundation section - fits section # 5	22	48x48x27	
4.81.0207.000	4' Foundation section - fits section # 6	29	48x48x30	
4.81.0208.000	4' Foundation section - fits section # 7	35	48x48x33	
4.81.0209.000	4' Foundation section - fits section # 8	39	48x48x36	
4.81.0210.000	4' Foundation section - fits section # 9	53	48x48x39	
4.81.0211.000	4' Foundation section - fits section #10	66	48x48x42	
4.81.0212.000	4' Foundation section - fits section #11	75	48x48x45	
4.81.0213.000	4' Foundation section - fits section #12	95	48x48x48	
4.81.0214.000	4' Foundation section - fits section #13	100	48x51x51	



<b>Base Foot Weldments</b> (alternate anchor type to embedment stub legs; does not include foundation bolts of any kind)				
Part Number	Description	Ship Wt. (lbs)	Ship LxWxH (in)	Image
4.82.0104.000	TITAN Base Foot Weldment # 4 - fits # 3	12	3@5x4x6	
4.82.0105.000	TITAN Base Foot Weldment # 5 - fits # 4	12	3@5x4x6	
4.82.0106.000	TITAN Base Foot Weldment # 6 - fits # 5	12	3@5x4x8	
4.82.0107.000	TITAN Base Foot Weldment # 7 - fits # 6	12	3@5x4x8	
4.82.0108.000	TITAN Base Foot Weldment # 8 - fits # 7	18	3@5x4x8	
4.82.0109.000	TITAN Base Foot Weldment # 9 - fits # 8	18	3@6x5x8	
4.82.0110.000	TITAN Base Foot Weldment #10 - fits # 9	33	3@6x5x8	
4.82.0111.000	TITAN Base Foot Weldment #11 - fits #10	33	3@8x6x8	
4.82.0112.000	TITAN Base Foot Weldment #12 - fits #11	33	3@8x6x8	
4.82.0113.000	TITAN Base Foot Weldment #13 - fits #12	33	3@8x6x8	
4.82.0114.000	TITAN Base Foot Weldment #14 - fits #13	63	3@10x6x8	

<b>Rock Bolts</b> (for sound and solid rock; base foot weldments sold separately)				
Part Number	Description	Ship Wt. (lbs)	Ship LxWxH (in)	Image
4.80.0100.100	5/8" x 5' Rock Bolts, 3-pak - fits # 3 - # 6	22	61x4x5	
4.80.0101.100	3/4" x 5' Rock Bolts, 3-pak - fits # 7 - # 8	24	61x4x5	
4.80.0102.100	1" x 5' Rock Bolts, 3-pak - fits # 9 - #12	45	61x4x5	
4.80.0102.200	1" x 5' Rock Bolts, 6 pak - fits #13	90	2@61x5x5	

Note: Rock bolts above are suitable provided the following rock conditions exist:

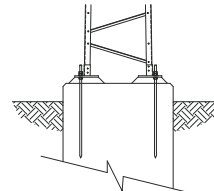

- 1) Rock quality – RQD 90% or better
- 2) Rock unit weight – 180 pcf
- 3) Exposed rock at surface (max 6" of earth cover)

<b>Anchor Bolt Kits</b> (for existing concrete pads and roofs; base foot weldments sold separately – includes bolts, adhesive compound, and hardware)				
Part Number	Description	Ship Wt. (lbs)	Ship LxWxH (in)	Image
4.80.0200.100	Anchor Bolt Kit, 3-pak - fits # 3 - # 6	22	1@36x2x2 + 1@8x8x8	
4.80.0200.200	Anchor Bolt Kit, 3-pak - fits # 7 - # 8	24	1@36x2x2 + 1@8x8x8	
4.80.0200.300	Anchor Bolt Kit, 3-pak - fits # 9 - #12	45	1@36x3x3 + 1@8x8x8	
4.80.0200.400	Anchor Bolt Kit, 6 pak - fits #13	90	1@36x4x4 + 1@8x8x8	

**Side Mount Kit** (with 2 angle frames, clip angles, u-bolt assemblies, and 6' pipe)

Part Number	Description	Ship Wt. (lbs)	Ship LxWxH (in)	Image
4.84.1141.000	Section # 2	22	15x6x6	
4.84.1142.000	Section # 3	23	18x6x6	
4.84.1151.000	Section # 4	25	21x6x6	
4.84.1152.000	Section # 5	27	24x6x6	
4.84.1161.000	Section # 6	28	27x6x6	
4.84.1162.000	Section # 7	29	30x6x6	
4.84.1171.000	Section # 8	31	33x6x6	
4.84.1172.000	Section # 9	33	36x6x6	
4.84.1181.000	Section #10	35	39x6x6	
4.84.1182.000	Section #11	36	42x6x6	
4.84.1191.000	Section #12	37	45x6x6	

**Cluster Antenna Mounts**

Part Number	Description	Ship Wt. (lbs)	Ship LxWxH (in)	Image
4.84.3CLS.00A	3-cluster Antenna Mount, 1.66" OD tube, fits TITAN SS	40	48x10x4	 <i>6-cluster Antenna Mount</i>  <i>3-cluster Antenna Mount</i>
4.84.6CLS.00A	6-cluster Antenna Mount, 1.66" OD tube, fits TITAN SS	80	2@48x10x4	

*Note: These cluster mounts install on the top pipe of the TITAN tower. They do NOT mount to the legs, they can be side mounted ONLY with the addition of a TITAN side-mount kit.*

*On a 6-cluster mount, the distance from one half of the cluster to the other half is 5.5".*

*Cluster mounts have built-in down tilt adjustment.*

**Surveillance Camera Mounting Accessory** (1.9"OD tubing x 6' long)

Part Number	Description	Ship Wt. (lbs)	Ship LxWxH (in)	Image
4.85.0101.000	Heavy duty flat plate welded at top, hot-dip galvanized	20	60x8x8	

<b>Thrust Bearing</b>				
Part Number	Description	Ship Wt. (lbs)	Ship LxWxH (in)	Image
4.600.2703.001	TB3 Thrust Bearing – supports up to 2"OD Mast	4	8x8x8	
4.600.2704.001	TB4 Thrust Bearing – supports up to 3"OD Mast	4	8x8x8	

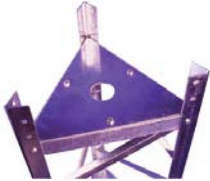
<b>Amateur Radio Mounts</b> (rotor plates for thrust bearing)				
Part Number	Description	Ship Wt. (lbs)	Ship LxWxH (in)	Image
4.89.0121.000	Rotor Plate, galvanized - top section # 2	8	15x15x1	
4.89.0122.000	Rotor Plate, galvanized - middle section # 2	9	16x16x1	
4.89.0131.000	Rotor Plate, galvanized - top section # 3	10	18x18x1	
4.89.0132.000	Rotor Plate, galvanized - middle section # 3	11	20x20x1	
4.89.0141.000	Rotor Plate, galvanized - top section # 4	14	22x22x1	
4.89.0142.000	Rotor Plate, galvanized - middle section # 4	15	24x24x1	
4.89.0151.000	Rotor Plate, galvanized - top section # 5	17	26x26x1	
4.89.0152.000	Rotor Plate, galvanized - middle section # 5	18	28x28x1	
4.89.0161.000	Rotor Plate, galvanized - top section # 6	19	30x30x1	
4.89.0162.000	Rotor Plate, galvanized - middle section # 6	20	32x32x1	
4.89.0171.000	Rotor Plate, galvanized - top section # 7	22	34x34x1	
4.89.0172.000	Rotor Plate, galvanized - middle section # 7	24	36x36x1	
4.89.0181.000	Rotor Plate, galvanized - top section # 8	28	38x38x1	
4.89.0182.000	Rotor Plate, galvanized - middle section # 8	30	40x40x1	

Note: If you are buying a Radio Mount for anything other than a top section, you must also purchase angle frames.

<b>Angle Frames</b> (with Hardware and U-bolts)				
Part Number	Description	Ship Wt. (lbs)	Ship LxWxH (in)	Image
4.83.0121.000	Angle Frame - top section # 2	5	15x15x1	
4.83.0122.000	Angle Frame - middle section # 2	5	16x16x1	
4.83.0122.100	Angle Frame - top and middle section # 2	10	16x16x1	
4.83.0131.000	Angle Frame - top section # 3	5	20x20x1	
4.83.0132.000	Angle Frame - middle section # 3	5	20x20x1	
4.83.0132.100	Angle Frame - top and middle section # 3	10	20x20x1	
4.83.0141.000	Angle Frame - top section # 4	8	24x24x1	
4.83.0142.000	Angle Frame - middle section # 4	8	24x24x1	
4.83.0142.100	Angle Frame - top and middle section # 4	15	24x24x1	
4.83.0151.000	Angle Frame - top section # 5	8	28x28x1	
4.83.0152.000	Angle Frame - middle section # 5	8	28x28x1	
4.83.0152.100	Angle Frame - top and middle section # 5	15	28x28x1	
4.83.0161.000	Angle Frame - top section # 6	10	32x32x1	
4.83.0162.000	Angle Frame - middle section # 6	10	32x32x1	
4.83.0162.100	Angle Frame - top and middle section # 6	20	32x32x1	
4.83.0171.000	Angle Frame - top section # 7	10	36x36x1	
4.83.0172.000	Angle Frame - middle section # 7	10	36x36x1	
4.83.0172.100	Angle Frame - top and middle section # 7	20	36x36x1	
4.83.0181.000	Angle Frame - top section # 8	13	40x40x1	
4.83.0182.000	Angle Frame - middle section # 8	13	40x40x1	
4.83.0182.100	Angle Frame - top and middle section # 8	25	40x40x1	

**Orange & White Factory Painting** (painted by baked enamel powder coat process)

Paint pricing available upon request, please contact your Trylon distributor.

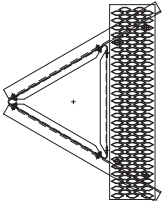

### Working Platforms

Part Number	Description	Ship Wt. (lbs)	Ship LxWxH (in)	Image
4.88.0102.230	Fits sections # 2 and # 3	50	32x10x4	
4.88.0102.456	Fits sections #4, # 5, and # 6	55	40x42x12	
4.88.0102.780	Fits sections # 7 and # 8	60	40x42x12	

### Lightning Rod

Part Number	Description	Ship Wt. (lbs)	Ship LxWxH (in)	Image
4.90.0100.000	Lightning Rod	10	96x6x6	

### Antenna Mounting Pipes (for top of tower)

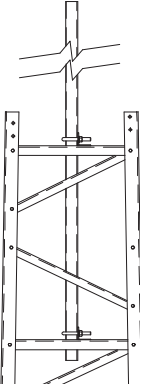
Part Number	Description	Ship Wt. (lbs)	Ship LxWxH (in)	Image
4.87.0101.000	1.9"OD Galv. Tubing x 6', sched. 40, inside diameter=1.625"	14	72x2x2	
4.87.0101.100	1.9"OD Galv. Tubing x 8', sched. 40, inside diameter=1.625"	18	96x2x2	
4.87.0101.200	1.9"OD Galv. Tubing x 10', sched. 40, inside diameter=1.625"	23	120x2x2	
4.87.0101.300	1.9"OD Galv. Tubing x 12', sched. 40, inside diameter=1.625"	28	144x2x2	
4.87.0102.000	2.375"OD Galvanized Tubing x 6', sched. 40	28	72x2.5x2.5	
4.87.0102.100	2.375"OD Galvanized Tubing x 8', sched. 40	37	96x2.5x2.5	
4.87.0102.200	2.375"OD Galvanized Tubing x 10', sched. 40	46	120x2.5x2.5	
4.87.0102.300	2.375"OD Galvanized Tubing x 12', sched. 40	56	144x2.5x2.5	
4.87.0103.000	2.875"OD Galvanized Tubing x 6', sched. 40	34	72x3x3	
4.87.0103.100	2.875"OD Galvanized Tubing x 8', sched. 40	46	96x3x3	
4.87.0103.200	2.875"OD Galvanized Tubing x 10', sched. 40	57	120x3x3	
4.87.0103.300	2.875"OD Galvanized Tubing x 12', sched. 40	68	144x3x3	

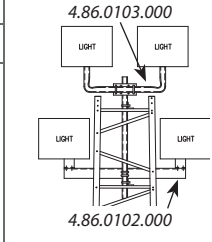

<b>Flood Light Supports</b> (for ballpark, stadium, and parking lot lighting)				
Part Number	Description	Ship Wt. (lbs)	Ship LxWxH (in)	Image
4.86.0103.000	Dual Light Bullhorn Mount, 30" wide	12	30x18x3	
4.86.0102.000	Dual Light Angle Mount, 48" wide	34	48x18x6	

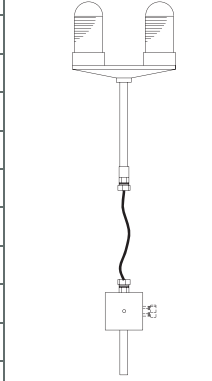
<b>Lighting Kits</b> (steady burning, dual red, non-alarmed)				
Part Number	Description	Ship Wt. (lbs)	Ship LxWxH (in)	Image
4.93.0102.000	16' Lighting Kit with Tech 90 cable	53	40x42x12	
4.93.0103.000	24' Lighting Kit with Tech 90 cable	55	40x42x12	
4.93.0104.000	32' Lighting Kit with Tech 90 cable	57	40x42x12	
4.93.0105.000	40' Lighting Kit with Tech 90 cable	58	40x42x16	
4.93.0106.000	48' Lighting Kit with Tech 90 cable	60	40x42x16	
4.93.0107.000	56' Lighting Kit with Tech 90 cable	60	40x42x18	
4.93.0108.000	64' Lighting Kit with Tech 90 cable	65	40x42x18	
4.93.0109.000	72' Lighting Kit with Tech 90 cable	67	40x42x20	
4.93.0110.000	80' Lighting Kit with Tech 90 cable	68	40x42x20	
4.93.0111.000	88' Lighting Kit with Tech 90 cable	69	40x42x24	
4.93.0112.000	96' Lighting Kit with Tech 90 cable	70	40x42x24	

<b>TITAN Replacement Bulbs</b>				
Part Number	Description	Ship Wt. (lbs)	Ship LxWxH (in)	Image
1404070	TITAN Red Obstruction Bulbs	0.5	10x10x10	

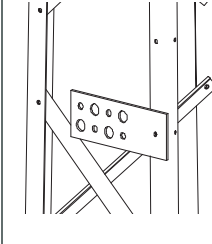
<b>TITAN Transmission Line Support Bracket</b> (1 pak, order 3 per section)				
Part Number	Description	Ship Wt. (lbs)	Ship LxWxH (in)	Image
4.84.0300.200	TITAN Tx Bracket	1	6x4x2	

**Diagonal Braces** (nuts and bolts sold separately, always replace nuts when replacing braces, do not re-use)

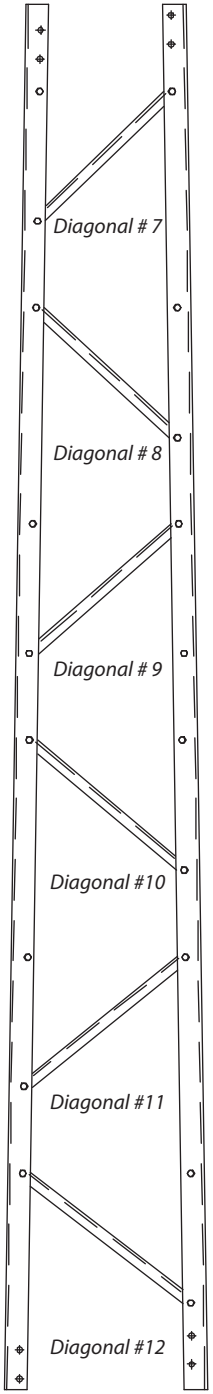
Part Number	Description	Ship Wt. (lbs)	Ship LxWxH (in)	Image
3.85.0022.107	TITAN SS Tower Diagonal # 7 (section # 2)	1	13x1x0.5	
3.85.0022.108	TITAN SS Tower Diagonal # 8 (section # 2)	1	15x1x0.5	
3.85.0022.109	TITAN SS Tower Diagonal # 9 (section # 2)	1	15x1x0.5	
3.85.0022.110	TITAN SS Tower Diagonal #10 (section # 2)	1	15x1x0.5	
3.85.0022.111	TITAN SS Tower Diagonal #11 (section # 2)	2	16x1x0.5	
3.85.0022.112	TITAN SS Tower Diagonal #12 (section # 2)	2	16x1x0.5	
3.85.0022.113	TITAN SS Tower Diagonal #13 (section # 3)	2	17x1x0.75	
3.85.0022.114	TITAN SS Tower Diagonal #14 (section # 3)	2	17x1x0.75	
3.85.0022.115	TITAN SS Tower Diagonal #15 (section # 3)	2	17x1x0.75	
3.85.0022.116	TITAN SS Tower Diagonal #16 (section # 3)	2	18x1x0.75	
3.85.0022.117	TITAN SS Tower Diagonal #17 (section # 3)	2	18x1x0.75	
3.85.0022.118	TITAN SS Tower Diagonal #18 (section # 3)	2	19x1x0.75	
3.85.0022.119	TITAN SS Tower Diagonal #19 (section # 4)	2	19x1x0.75	
3.85.0022.120	TITAN SS Tower Diagonal #20 (section # 4)	2	20x1x0.75	
3.85.0022.121	TITAN SS Tower Diagonal #21 (section # 4)	2	20x1x0.75	
3.85.0022.122	TITAN SS Tower Diagonal #22 (section # 4)	2	20x1x0.75	
3.85.0022.123	TITAN SS Tower Diagonal #23 (section # 4)	2	21x1x0.75	
3.85.0022.124	TITAN SS Tower Diagonal #24 (section # 4)	2	21x1x0.75	
3.85.0022.125	TITAN SS Tower Diagonal #25 (section # 5)	2	22x1.25x1	
3.85.0022.126	TITAN SS Tower Diagonal #26 (section # 5)	2	22x1.25x1	
3.85.0022.127	TITAN SS Tower Diagonal #27 (section # 5)	2	23x1.25x1	
3.85.0022.128	TITAN SS Tower Diagonal #28 (section # 5)	2	23x1.25x1	
3.85.0022.129	TITAN SS Tower Diagonal #29 (section # 5)	2	24x1.25x1	
3.85.0022.130	TITAN SS Tower Diagonal #30 (section # 5)	2	24x1.25x1	
3.85.0022.131	TITAN SS Tower Diagonal #31 (section # 6)	2	24x1.25x1	
3.85.0022.132	TITAN SS Tower Diagonal #32 (section # 6)	2	25x1.25x1	
3.85.0022.133	TITAN SS Tower Diagonal #33 (section # 6)	2	25x1.25x1	
3.85.0022.134	TITAN SS Tower Diagonal #34 (section # 6)	2	25x1.25x1	
3.85.0022.135	TITAN SS Tower Diagonal #35 (section # 6)	2	26x1.25x1	
3.85.0022.136	TITAN SS Tower Diagonal #36 (section # 6)	2	27x1.25x1	
3.85.0022.137	TITAN SS Tower Diagonal #37 (section # 7)	2	27x1.25x1	
3.85.0022.138	TITAN SS Tower Diagonal #38 (section # 7)	2	28x1.25x1	
3.85.0022.139	TITAN SS Tower Diagonal #39 (section # 7)	2	28x1.25x1	
3.85.0022.140	TITAN SS Tower Diagonal #40 (section # 7)	2	29x1.25x1	
3.85.0022.141	TITAN SS Tower Diagonal #41 (section # 7)	2	29x1.25x1	
3.85.0022.142	TITAN SS Tower Diagonal #42 (section # 7)	2	30x1.25x1	
3.85.0022.143	TITAN SS Tower Diagonal #43 (section # 8)	2	30x1.25x1	
3.85.0022.144	TITAN SS Tower Diagonal #44 (section # 8)	2	31x1.25x1	
3.85.0022.145	TITAN SS Tower Diagonal #45 (section # 8)	2	31x1.25x1	
3.85.0022.146	TITAN SS Tower Diagonal #46 (section # 8)	2	31x1.25x1	
3.85.0022.147	TITAN SS Tower Diagonal #47 (section # 8)	2	32x1.25x1	
3.85.0022.148	TITAN SS Tower Diagonal #48 (section # 8)	2	32x1.25x1	
3.85.0022.149	TITAN SS Tower Diagonal #49 (section # 9)	3	33x1.5x1.25	
3.85.0022.150	TITAN SS Tower Diagonal #50 (section # 9)	3	33x1.5x1.25	
3.85.0022.151	TITAN SS Tower Diagonal #51 (section # 9)	3	34x1.5x1.25	
3.85.0022.152	TITAN SS Tower Diagonal #52 (section # 9)	3	34x1.5x1.25	
3.85.0022.153	TITAN SS Tower Diagonal #53 (section # 9)	3	35x1.5x1.25	
3.85.0022.154	TITAN SS Tower Diagonal #54 (section # 9)	3	35x1.5x1.25	
3.85.0022.155	TITAN SS Tower Diagonal #55 (section #10)	3	36x1.5x1.25	
3.85.0022.156	TITAN SS Tower Diagonal #56 (section #10)	4	36x1.5x1.25	
3.85.0022.157	TITAN SS Tower Diagonal #57 (section #10)	4	37x1.5x1.25	
3.85.0022.158	TITAN SS Tower Diagonal #58 (section #10)	4	37x1.5x1.25	
3.85.0022.159	TITAN SS Tower Diagonal #59 (section #10)	4	38x1.5x1.25	

<b>Diagonal Braces</b> (nuts and bolts sold separately, always replace nuts when replacing braces, do not re-use)				
Part Number	Description	Ship Wt. (lbs)	Ship LxWxH (in)	Image
3.85.0022.160	TITAN SS Tower Diagonal #60 (section #10)	4	38x1.5x1.25	See page 20.
3.85.0022.161	TITAN SS Tower Diagonal #61 (section #11)	4	38x1.75x1.25	
3.85.0022.162	TITAN SS Tower Diagonal #62 (section #11)	4	38x1.75x1.25	
3.85.0022.163	TITAN SS Tower Diagonal #63 (section #11)	4	39x1.75x1.25	
3.85.0022.164	TITAN SS Tower Diagonal #64 (section #11)	4	39x1.75x1.25	
3.85.0022.165	TITAN SS Tower Diagonal #65 (section #11)	4	40x1.75x1.25	
3.85.0022.166	TITAN SS Tower Diagonal #66 (section #11)	4	40x1.75x1.25	
3.85.0022.167	TITAN SS Tower Diagonal #67 (section #12)	4	41x1.75x1.25	
3.85.0022.168	TITAN SS Tower Diagonal #68 (section #12)	5	41x1.75x1.25	
3.85.0022.169	TITAN SS Tower Diagonal #69 (section #12)	5	42x1.75x1.25	
3.85.0022.170	TITAN SS Tower Diagonal #70 (section #12)	5	42x1.75x1.25	
3.85.0022.171	TITAN SS Tower Diagonal #71 (section #12)	5	43x1.75x1.25	
3.85.0022.172	TITAN SS Tower Diagonal #72 (section #12)	5	43x1.75x1.25	
3.85.0022.173	TITAN SS Tower Diagonal #73 (section #13)	5	46x2x2	
3.85.0022.174	TITAN SS Tower Diagonal #74 (section #13)	5	46x2x2	
3.85.0022.175	TITAN SS Tower Diagonal #75 (section #13)	5	46x2x2	
3.85.0022.176	TITAN SS Tower Diagonal #76 (section #13)	5	47x2x2	
3.85.0022.177	TITAN SS Tower Diagonal #77 (section #13)	5	47x2x2	
3.85.0022.178	TITAN SS Tower Diagonal #78 (section #13)	5	48x2x2	

<b>Replacement Nuts and Washers for Diagonal Braces</b> (minimum order: 200 pieces)				
Part Number	Description	Ship Wt. (lbs)	Ship LxWxH (in)	Image
1205020	1/4" Kep Nut and Integral Washer	0.01	8x8x8	
1205040	5/16" Kep Nut and Integral Washer	0.01	8x8x8	
1205060	3/8" Kep Nut and Integral Washer	0.02	8x8x8	

<b>Replacement Bolts for Diagonal Braces</b> (minimum order: 200 pieces)				
Part Number	Description	Ship Wt. (lbs)	Ship LxWxH (in)	Image
1205010	1/4" x 1/2" Bolt for braces - fits # 7-48	0.02	12x12x12	
1205011	1/4" x 3/4" Bolt for braces/angle frames	0.02	12x12x12	
1205030	5/16" x 3/4" Bolt for braces - fits #49-72	0.02	12x12x12	
1205050	3/8" x 3/4" Bolt for braces - fits #73-78	0.03	12x12x12	

### Replacement Tower Legs *(hardware sold separately; UPS shippable)*

Part Number	Description	Ship Wt. (lbs)	Ship LxWxH (in)	Image
3.85.0021.002	TITAN SS Tower Leg # 2	7	96x2.3x1.7	
3.85.0021.003	TITAN SS Tower Leg # 3	8	96x2.3x1.7	
3.85.0021.004	TITAN SS Tower Leg # 4	10	96x2.9x2	
3.85.0021.005	TITAN SS Tower Leg # 5	10	96x3x2.2	
3.85.0021.006	TITAN SS Tower Leg # 6	15	96x3x2.2	
3.85.0021.007	TITAN SS Tower Leg # 7	16	96x3.6x2.5	
3.85.0021.008	TITAN SS Tower Leg # 8	18	96x3.9x2.8	
3.85.0021.009	TITAN SS Tower Leg # 9	20	96x4.3x3	
3.85.0021.010	TITAN SS Tower Leg #10	26	96x4.6x3.25	
3.85.0021.011	TITAN SS Tower Leg #11	28	96x5x3.5	
3.85.0021.012	TITAN SS Tower Leg #12	29	96x5.3x3.75	
3.85.0021.013	TITAN SS Tower Leg #13	36	96x5.7x4	

### Splice Bolt Kits *(for attaching tower sections together)*

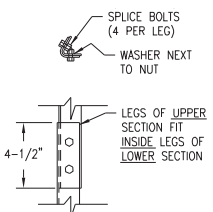
Part Number	Description	Ship Wt. (lbs)	Ship LxWxH (in)	Image
4.78.0212.000	For connecting sections # 2 to # 3	0.4	6x4x2	
4.78.0211.000	For connecting sections # 3 to # 4	0.4	6x4x2	
4.78.0210.000	For connecting sections # 4 to # 5	0.4	6x4x2	
4.78.0209.000	For connecting sections # 5 to # 6	0.4	6x4x2	
4.78.0208.000	For connecting sections # 6 to # 7	0.4	6x4x2	
4.78.0207.000	For connecting sections # 7 to # 8	1.0	6x4x2	
4.78.0206.000	For connecting sections # 8 to # 9	1.0	6x4x2	
4.78.0205.000	For connecting sections # 9 to # 10	1.2	6x4x2	
4.78.0204.000	For connecting sections # 10 to # 11	1.2	6x4x2	
4.78.0203.000	For connecting sections # 11 to # 12	4.2	6x4x2	
4.78.0202.000	For connecting sections # 12 to # 13	4.2	6x4x2	
4.78.0201.000	For connecting sections # 13 to Anchor Stub Leg #14	4.2	6x4x2	
4.78.0202.200	Complete Splice Kit for 96' T200	19	16x16x12	

# Concrete Foundation Details TITAN<sup>®</sup>TOWER SELF-SUPPORT

(Normal dry soil)

How to use this page:

1. Determine what section number is at the bottom of your specific tower model.
2. Using "Chart A", find the anchor type that corresponds to the bottom section of your tower.
3. Using "Chart B", find dimensions that match your anchor type.

Chart A

If Bottom Tower Section Is:	Use Anchor Type from Chart B
#3	1
#4	1
#5	1
#6	1
#7	2
#8	2
#9	3
#10	3
#11	3
#12	3
#13	4

Chart B

ANCHOR TYPE	"B" (FEET)	"W" (FEET)	"L" (FEET)	"X" HORIZONTAL REINFORCING	"Y" VERTICAL REINFORCING	OVERTURNING MOMENT (FT. KIPS)	SHEAR (KIPS)	CONCRETE VOLUME CUBIC YARDS
1	3	4	4	4	16	17	0.7	2.0
2	4	5	5	5	20	28	1.0	4.0
3	5	7	5	5	20	67	1.7	6.0
4	5.5	7.5	5.5	6	24	105	3.0	7.0

Visit [www.trylon.com](http://www.trylon.com) for full foundation installation details, including foundation notes.

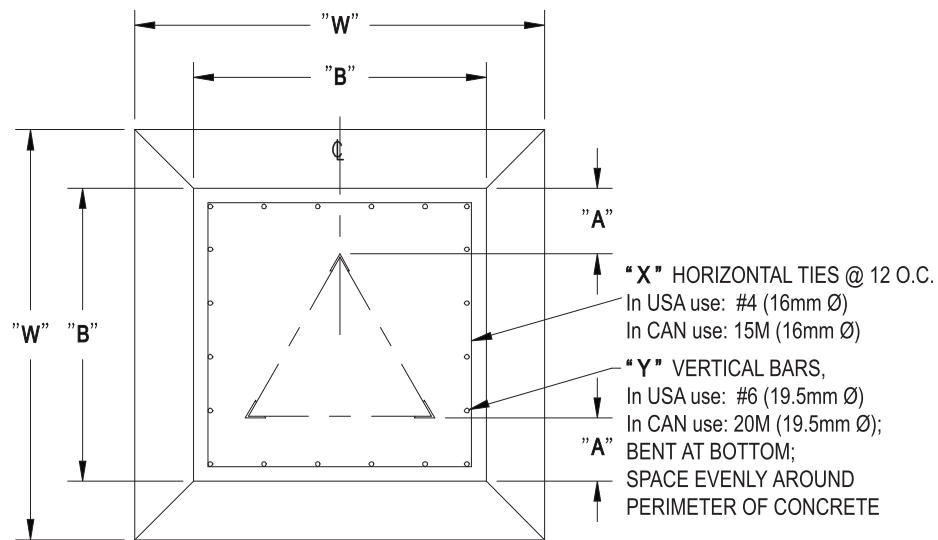

FOUNDATION PLAN

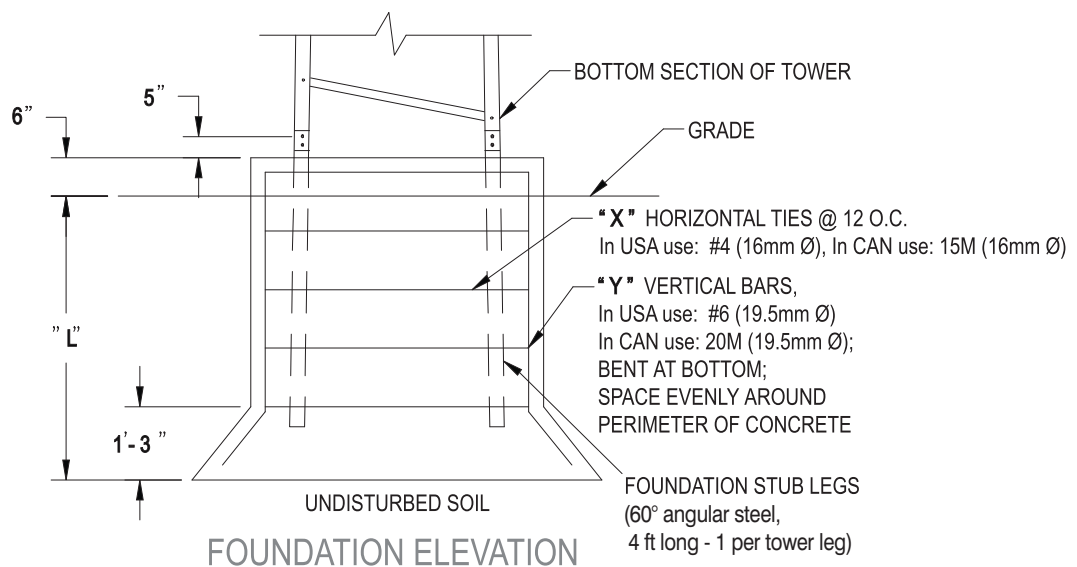

FOUNDATION ELEVATION

# TITAN<sup>®</sup> TOWER SELF-SUPPORT Concrete Foundation Details

(For applications with weak soil or shallow water table)

PLAN VIEW

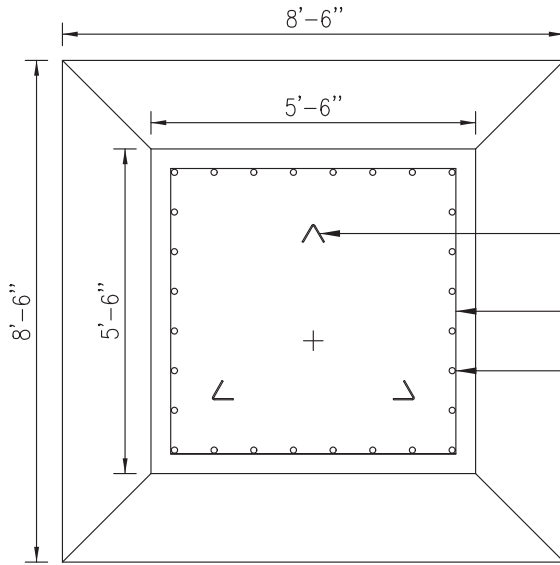

Visit [www.trylon.com](http://www.trylon.com) for full foundation installation details, including foundation notes.

- Install Stub Legs into Concrete (3 req'd)
- (6) 15M/#4 Horizontal Ties
- (24) 20M/#6 Vertical Bars

ELEV VIEW

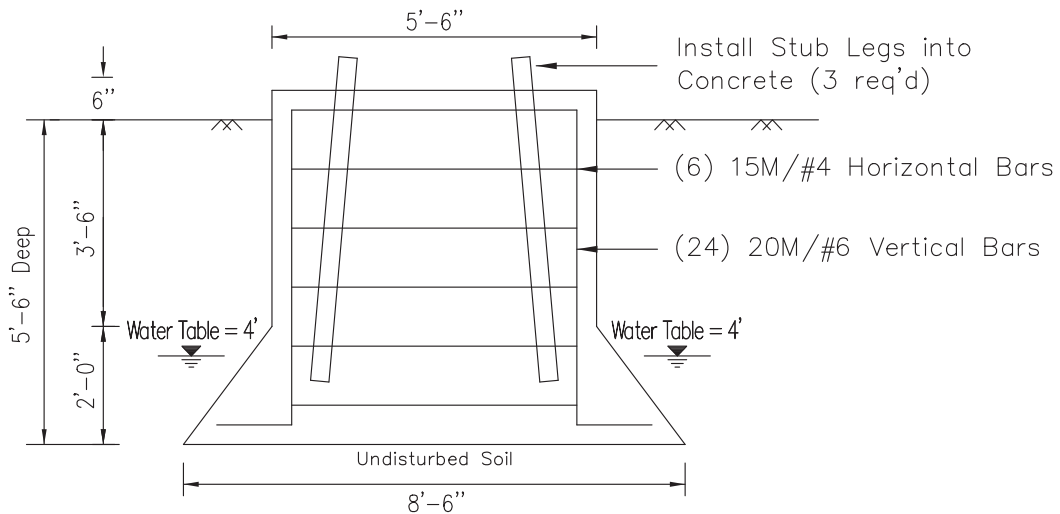

Overturing Moment = 105 k-ft  
Horizontal Shear = 3.0 kips

**Notes:**

1. Assumed Soil Parameters:  
 Allowable Soil Capacity = 2.0 ksf\*  
 Water table at 4' depth below surface\*  
 Dry density of 100 pcf  
 Kp - Ka = 2.7  
 Friction angle of 30°
2. This drawing illustrates a foundation for TITAN SS Towers using bottom section #13.





**SUPER  
TITAN™** **KD**

- .. Compliant to TIA/EIA 222-F and TIA/EIA 222-G
- .. Up to 190' Self-Support Tower
- .. Standard 10' sections
- .. Stocked at our distribution partners for quick delivery
- .. All members are hot-dip galvanized throughout to provide years of trouble free service
- .. Applications:
  - ... *Microwave repeaters up to 130'*
  - ... *Wireless broadband*
  - ... *Police and fire dispatch*
  - ... *High wind coastal zones*
- .. P.E. Stamp available

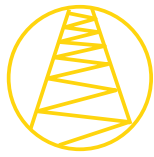

## Wind load capacity per TIA/EIA 222 standard (Rev. F)

TIA/EIA (Rev. F) was released in June 1996, currently both TIA/EIA Rev. F and Rev. G standards are being used. Please verify with your local permit agency which code is applicable for your location. Major differences from Rev F to Rev. G include: Rev. F has one structure classification, while Rev. G has three — explained below. Also, Rev. F uses fastest wind mile wind speed as opposed to three second gusts for Rev. G. For comparative purposes, 70mph fastest wind mile is equivalent to 85mph 3-second gust.

## Wind load capacity per latest revision of TIA/EIA 222 standard (Rev. G)

On January 1, 2006, a new revision (Rev G) of the national standard for tower design (TIA/EIA 222) was issued. The previous revision which is also still in force, is called Rev F. Revision G made many significant changes vs. Rev F. One of the changes was to introduce a ‘classification’ system for different tower structures which allows an Engineer to design a greater or lesser ‘safety factor’ into the tower depending upon it’s intended use and the risk of danger to human life. See Table 1 for the class descriptions. TIA/EIA uses maximum 3-second gust wind speed.

### Classification of Structures

Classification Criteria	Reliability Class
<i>Structures that due to height, use or location represent a low hazard to human life and damage to property in the event of failure and/or used for services that are optional and/or where a delay in returning the services would be acceptable. Class 1 structures need not be designed with any ice loading or earthquake consideration.</i>	<b>1</b>
<i>Structures that due to height, use or location represent a substantial hazard to human life and/or damage to property in the event of failure and/or used for services that may be provided by other means. These structures must consider ice loading and earthquake loading.</i>	<b>2</b>
<i>Structures that due to height, use or location represent a high hazard to human life and/or damage to property in the event of failure and/or used for services that may be provided by other means. These structures must consider ice loading and earthquake loading.</i>	<b>3</b>

To assist Trylon customers who require Rev. G. design for their SuperTitan, we have provided the allowable antenna area chart below, which is based on Class 1 structures. For Class 2 or 3, contact Trylon TSF or your Distributor’s Tech Support group.

# 20' Towers



Model Designation:		S100	S200	S300	S400	S500		
Knocked-down Part Number:		5.94.0100.020	5.94.0200.020	5.94.0300.020	5.94.0400.020	5.94.0500.020		
Assembled Part Number:		5.95.0100.020	5.95.0200.020	5.95.0300.020	5.95.0400.020	5.95.0500.020		
Includes 5' embedment section for concrete foundation, splice hardware, and pipe anchor brackets for antenna mounting pipe (pipe sold separately on page 68).  Knocked-down towers reduce shipping cost in comparison with pre-assembled.								
Allowable antenna area in ft <sup>2</sup> at:*	EIA 222-F 70/90/100 mph wind no ice	Round: 90/50/35 Flat: 64/35/25	Round: 100/60/45 Flat: 71/42/32	Round: 120/70/55 Flat: 85/50/39	Round: 140/80/60 Flat: 100/57/42	Round: 203/117/91 Flat: 145/83/65		
	EIA Rev.G Class 1 90/105/120 mph wind 3/4" ice	Round: 78/52/38 Flat: 52/35/25	Round: 92/64/46 Flat: 61/43/31	Round: 108/74/54 Flat: 72/49/36	Round: 122/86/62 Flat: 81/57/41	Round: 254/182/136 Flat: 169/121/91		
	EIA Rev.G Class 2 90/105/120 mph wind 3/4" ice	Round: 66/46/32 Flat: 44/31/21	Round: 78/54/40 Flat: 52/36/27	Round: 92/64/46 Flat: 61/43/31	Round: 104/72/52 Flat: 69/48/35	Round: 218/156/116 Flat: 145/104/77		
Knocked-down Towers	L"xW"xH"	133x48x15	133x48x15	133x48x15	133x48x15	133x48x16		
Assembled Towers	L"xW"xH"	133x48x24	133x48x28	133x48x31	133x60x34	133x60x43		
Shipping Weight (lbs)		565	578	597	624	731		

\*Assumptions: Projected areas (PA) shown are bare; a 1.5 multiplier used for iced area; loads centrally located and balanced at tower top; considers step-pegs, safety cable, and one 1/2" tx line per 10 sq.ft.; "-" indicates tower failure.  
\*Round antennas include omnis, dipoles, dishes with radomes, etc. Antennas where wind hits a round surface. Flat Antennas include flat panels, dishes without radomes and cameras, where wind hits a flat surface.

## Common Accessories

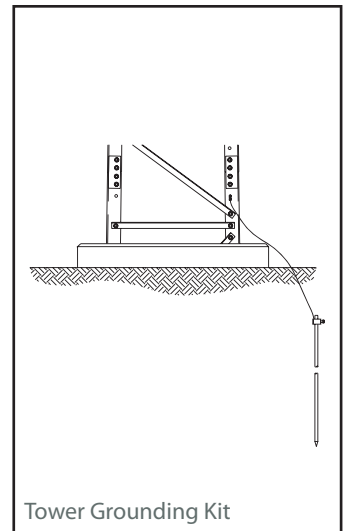

Accessory:	S100	S200	S300	S400	S500		
<b>Cable Safety Climb Kits</b> <i>no slider</i>	4.99.0485.050	4.99.0485.050	4.99.0485.050	4.99.0485.050	4.99.0485.050		
<b>Step-Bolt Kit</b> <i>leg mounted</i>	4.98.0100.020	4.98.0100.020	4.98.0100.020	4.98.0100.020	4.98.0100.020		
<b>Anti-Climb Shield Kits</b>	4.92.0001.002	4.92.0001.003	4.92.0001.004	4.92.0001.005	4.92.0001.006		
<b>Tower Grounding Kit</b> <i>basic, single leg</i>	4.91.0103.000	4.91.0103.000	4.91.0103.000	4.91.0103.000	4.91.0103.000		

For more SuperTitan Accessories and Replacement Parts, see pages 61 to 76.

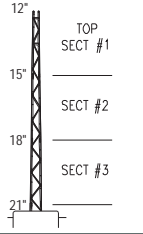
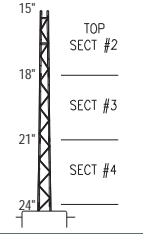
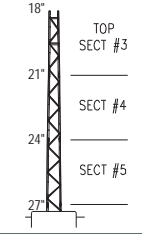
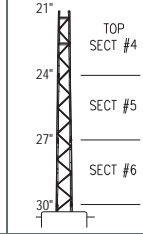
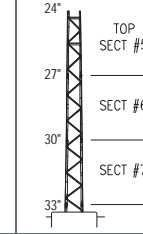
Model Designation:		S100	S200	S300	S400	S500		
Knocked-down Part Number:		5.94.0100.030	5.94.0200.030	5.94.0300.030	5.94.0400.030	5.94.0500.030		
Assembled Part Number:		5.95.0100.030	5.95.0200.030	5.95.0300.030	5.95.0400.030	5.95.0500.030		
Includes 5' embedment section for concrete foundation, splice hardware, and pipe anchor brackets for antenna mounting pipe (pipe sold separately on page 68).  Knocked-down towers reduce shipping cost in comparison with pre-assembled.								
Allowable antenna area in ft <sup>2</sup> *	EIA 222-F 70/90/100 mph wind no ice	Round: 50/25/20 Flat: 35/17/14	Round: 60/30/21 Flat: 42/21/15	Round: 70/35/23 Flat: 50/25/16	Round: 140/75/56 Flat: 100/53/40	Round: 191/105/80 Flat: 136/75/57		
	EIA Rev.G Class 1 90/105/120 mph wind 3/4" ice	Round: 46/30/18 Flat: 31/20/12	Round: 52/34/24 Flat: 35/23/16	Round: 60/40/28 Flat: 40/27/19	Round: 112/78/56 Flat: 75/52/37	Round: 186/130/94 Flat: 124/87/63		
	EIA Rev.G Class 2 90/105/120 mph wind 3/4" ice	Round: 38/24/14 Flat: 25/16/9	Round: 44/30/18 Flat: 29/20/12	Round: 50/32/22 Flat: 33/21/15	Round: 94/66/46 Flat: 63/44/31	Round: 158/110/78 Flat: 105/73/52		
Knocked-down Towers	L"xW"xH"	133x48x15	133x48x15	133x48x15	133x48x16	133x48x16		
Assembled Towers	L"xW"xH"	133x48x27	133x60x31	133x60x34	133x75x37	133x75x40		
Shipping Weight (lbs)		856	875	908	1,018	1,139		

\*Assumptions: Projected areas (PA) shown are bare; a 1.5 multiplier used for iced area; loads centrally located and balanced at tower top; considers step-pegs, safety cable, and one 1/2" tx line per 10 sq.ft.; "-" indicates tower failure.  
\*Round antennas include omnis, dipoles, dishes with radomes, etc. Antennas where wind hits a round surface. Flat Antennas include flat panels, dishes without radomes and cameras, where wind hits a flat surface.

## Common Accessories

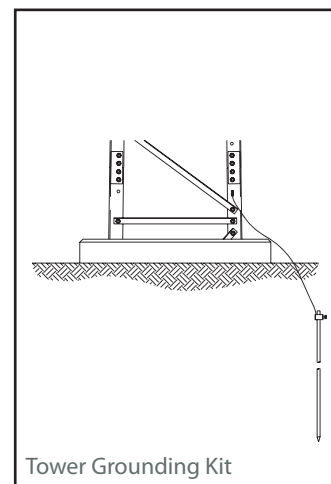

Accessory:	S100	S200	S300	S400	S500		
<b>Cable Safety Climb Kits</b> no slider	4.99.0485.050	4.99.0485.050	4.99.0485.050	4.99.0485.050	4.99.0485.050		
<b>Step-Bolt Kit</b> leg mounted	4.98.0100.030	4.98.0100.030	4.98.0100.030	4.98.0100.030	4.98.0100.030		
<b>Anti-Climb Shield Kits</b>	4.92.0001.003	4.92.0001.004	4.92.0001.005	4.92.0001.006	4.92.0001.007		
<b>Tower Grounding Kit</b> basic, single leg	4.91.0103.000	4.91.0103.000	4.91.0103.000	4.91.0103.000	4.91.0103.000		

For more SuperTitan Accessories and Replacement Parts, see pages 61 to 76.



# 40' Towers



Model Designation:		S100	S200	S300	S400	S500		
Knocked-down Part Number:		5.94.0100.040	5.94.0200.040	5.94.0300.040	5.94.0400.040	5.94.0500.040		
Assembled Part Number:		5.95.0100.040	5.95.0200.040	5.95.0300.040	5.95.0400.040	5.95.0500.040		
<p><i>Includes 5' embedment section for concrete foundation, splice hardware, and pipe anchor brackets for antenna mounting pipe (pipe sold separately on page 68).</i></p> <p><i>Knocked-down towers reduce shipping cost in comparison with pre-assembled.</i></p>								
Allowable antenna area in ft <sup>2</sup> *K	EIA 222-F 70/90/100 mph wind no ice	Round: 40/15/8 Flat: 28/10/5	Round: 45/17/10 Flat: 32/12/7	Round: 70/35/27 Flat: 50/25/19	Round: 135/77/57 Flat: 96/55/40	Round: 157/83/60 Flat: 112/59/42		
	EIA Rev.G Class 1 90/105/120 mph wind 3/4" ice	Round: 28/14/8 Flat: 19/9/5	Round: 32/18/10 Flat: 21/12/7	Round: 56/36/24 Flat: 37/24/16	Round: 104/72/52 Flat: 69/48/35	Round: 126/84/56 Flat: 84/56/37		
	EIA Rev.G Class 2 90/105/120 mph wind 3/4" ice	Round: 22/12/4 Flat: 15/8/3	Round: 26/14/6 Flat: 17/9/4	Round: 46/30/18 Flat: 31/20/12	Round: 88/60/44 Flat: 59/40/29	Round: 106/68/46 Flat: 71/45/31		
Knocked-down Towers	L"xW"xH"	133x48x24	133x48x24	133x48x24	133x48x24	133x48x24		
Assembled Towers	L"xW"xH"	133x60x31	133x60x34	133x60x37	133x75x40	133x75x43		
Shipping Weight (lbs)		1,078	1,111	1,241	1,351	1,467		

\*Assumptions: Projected areas (PA) shown are bare; a 1.5 multiplier used for iced area; loads centrally located and balanced at tower top; considers step-pegs, safety cable, and one 1/2" tx line per 10 sq.ft.; "-" indicates tower failure.  
 \*Round antennas include omnis, dipoles, dishes with radomes, etc. Antennas where wind hits a round surface. Flat Antennas include flat panels, dishes without radomes and cameras, where wind hits a flat surface.

## Common Accessories

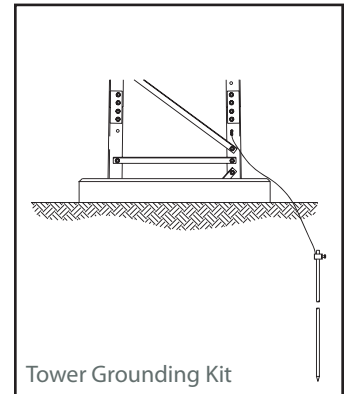

Accessory:	S100	S200	S300	S400	S500		
<b>Cable Safety Climb Kits</b> no slider	4.99.0485.050	4.99.0485.050	4.99.0485.050	4.99.0485.050	4.99.0485.050		
<b>Step-Bolt Kit</b> leg mounted	4.98.0100.040	4.98.0100.040	4.98.0100.040	4.98.0100.040	4.98.0100.040		
<b>Anti-Climb Shield Kits</b>	4.92.0001.004	4.92.0001.005	4.92.0001.006	4.92.0001.007	4.92.0001.008		
<b>Tower Grounding Kit</b> basic, single leg	4.91.0103.000	4.91.0103.000	4.91.0103.000	4.91.0103.000	4.91.0103.000		

For more SuperTitan Accessories and Replacement Parts, see pages 61 to 76.

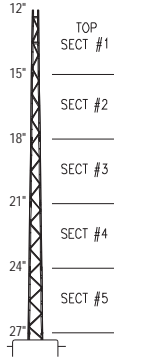
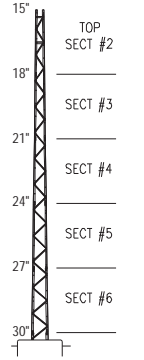
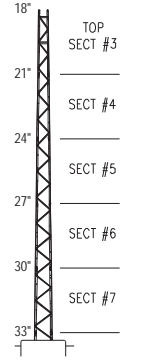
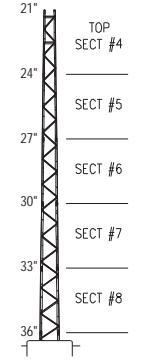
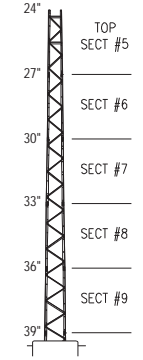
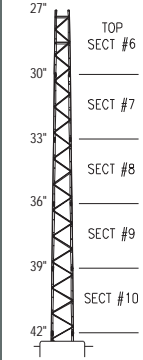
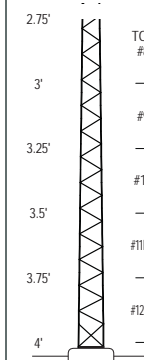
Model Designation:	S100	S200	S300	S400	S500	S600	H800	
Knocked-down Part Number:	5.94.0100.050	5.94.0200.050	5.94.0300.050	5.94.0400.050	5.94.0500.050	5.94.0600.050	5.94.H800.050	
Assembled Part Number:	5.95.0100.050	5.95.0200.050	5.95.0300.050	5.95.0400.050	5.95.0500.050	5.95.0600.050	5.95.H800.050	
Includes anchor material for concrete foundation, splice hardware, and pipe anchor brackets for antenna mounting pipe (pipe sold separately on page 68).  Models S100 to H800 use a 5" embedment section as the anchor for concrete.  Knocked-down towers reduce shipping cost in comparison with pre-assembled.								
Allowable antenna area in ft <sup>2</sup> *	EIA 222-F 70/90/100 mph wind no ice	Round: 22/3/-- Flat: 15/2/--	Round: 40/15/10 Flat: 28/10/7	Round: 60/30/24 Flat: 42/21/17	Round: 90/44/26 Flat: 64/31/18	Round: 100/47/30 Flat: 71/33/21	Round: 110/50/30 Flat: 78/35/21	Round: 113/57/41 Flat: 80/40/29
	EIA Rev.G Class 1 90/105/120 mph wind 3/4" ice	Round: 14/6/-- Flat: 9/4/--	Round: 30/16/8 Flat: 20/11/5	Round: 52/34/22 Flat: 35/23/15	Round: 82/50/32 Flat: 55/33/21	Round: 88/54/34 Flat: 59/36/23	Round: 128/84/54 Flat: 85/56/36	Round: 154/102/68 Flat: 103/68/45
	EIA Rev.G Class 2 90/105/120 mph wind 3/4" ice	Round: 12/--/-- Flat: 8/--/--	Round: 24/12/4 Flat: 16/8/3	Round: 44/28/16 Flat: 29/19/11	Round: 66/42/24 Flat: 44/28/16	Round: 72/44/28 Flat: 48/29/19	Round: 108/68/44 Flat: 72/45/29	Round: 128/84/54 Flat: 85/56/36
Knocked-down Towers	L"xW"xH"	133x48x24	133x48x24	133x48x24	133x48x25	133x48x25	133x48x25	122x48x26
Assembled Towers	L"xW"xH"	133x60x34	133x60x37	133x75x40	133x75x43	133x75x46	133x75x49	133x91x52
Shipping Weight (lbs)	1,314	1,430	1,560	1,679	1,798	1,932	2,479	

\*Assumptions: Projected areas (PA) shown are bare; a 1.5 multiplier used for iced area; loads centrally located and balanced at tower top; considers step-pegs, safety cable, and one 1/2" tx line per 10 sq.ft.; "--" indicates tower failure.  
\*Round antennas include omnis, dipoles, dishes with radomes, etc. Antennas where wind hits a round surface. Flat Antennas include flat panels, dishes without radomes and cameras, where wind hits a flat surface.

## Common Accessories

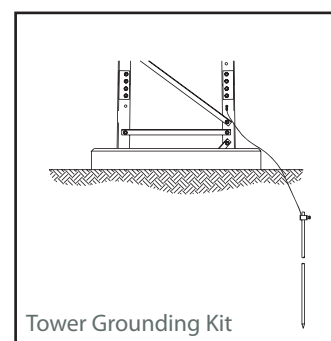
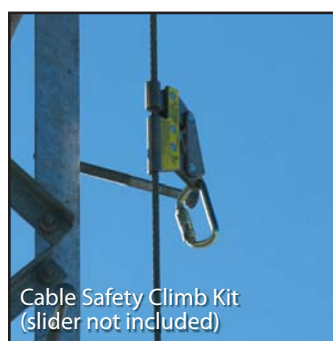

Accessory:	S100	S200	S300	S400	S500	S600	H800
<b>Cable Safety Climb Kits</b> no slider	4.99.0485.050	4.99.0485.050	4.99.0485.050	4.99.0485.050	4.99.0485.050	4.99.0485.050	4.99.0485.050
<b>Step-Bolt Kit</b> leg mounted	4.98.0100.050	4.98.0100.050	4.98.0100.050	4.98.0100.050	4.98.0100.050	4.98.0100.050	4.98.0100.050
<b>Anti-Climb Shield Kits</b>	4.92.0001.005	4.92.0001.006	4.92.0001.007	4.92.0001.008	4.92.0001.009	4.92.0001.010	4.92.0001.012
<b>Tower Grounding Kit</b> basic, single leg	4.91.0103.000	4.91.0103.000	4.91.0103.000	4.91.0103.000	4.91.0103.000	4.91.0103.000	4.91.0103.000

For more SuperTitan Accessories and Replacement Parts, see pages 61 to 76.

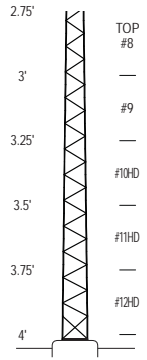
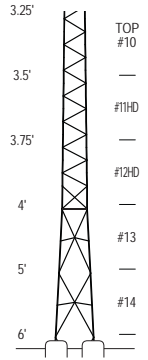
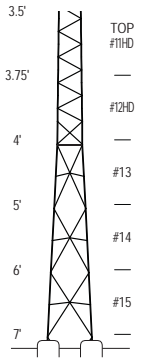
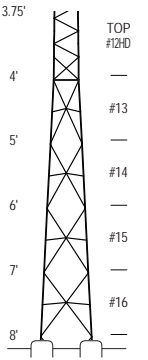

Model Designation:		H810	S1000	S1100	S1200			
Knocked-down Part Number:		5.94.H810.050	5.94.1000.050	5.94.1100.050	5.94.1200.050			
Assembled Part Number:		5.95.H810.050	N/A	N/A	N/A			
<p><i>Includes anchor material for concrete foundation, splice hardware, and pipe anchor brackets for antenna mounting pipe (pipe sold separately on page 68).</i></p> <p><i>Model H810 uses a 5' embedment section as the anchor for concrete; models S1000 to S1200 use base feet and tie-rods for concrete foundation.</i></p> <p><i>Knocked-down towers reduce shipping cost in comparison with pre-assembled.</i></p>								
Allowable antenna area in ft <sup>2</sup> *	EIA 222-F 70/90/100 mph wind no ice	Round: TBA Flat: TBA	Round: 119/67/53 Flat: 85/47/37	Round: 180/100/70 Flat: 128/71/50	Round: 187/103/80 Flat: 133/73/57			
	EIA Rev.G Class 1 90/105/120 mph wind 3/4" ice	Round: 154/102/68 Flat: 103/68/45	Round: 274/186/126 Flat: 183/124/84	Round: 276/188/122 Flat: 184/125/81	Round: 278/190/134 Flat: 185/127/89			
	EIA Rev.G Class 2 90/105/120 mph wind 3/4" ice	Round: 128/84/54 Flat: 85/56/36	Round: 230/152/102 Flat: 153/101/68	Round: 236/152/92 Flat: 157/101/63	Round: 234/158/110 Flat: 156/105/73			
Knocked-down Towers	L"xW"xH"	122x48x26	133x48x48	133x48x48	133x48x48			
Assembled Towers	L"xW"xH"	133x91x52	N/A	N/A	N/A			
Shipping Weight (lbs)		2,526	4,024	4,359	4,668			

\*Assumptions: Projected areas (PA) shown are bare; a 1.5 multiplier used for iced area; loads centrally located and balanced at tower top; considers step-pegs, safety cable, and one 1/2" tx line per 10 sq.ft.; "-" indicates tower failure.  
\*Round antennas include omnis, dipoles, dishes with radomes, etc. Antennas where wind hits a round surface. Flat Antennas include flat panels, dishes without radomes and cameras, where wind hits a flat surface.

## Common Accessories

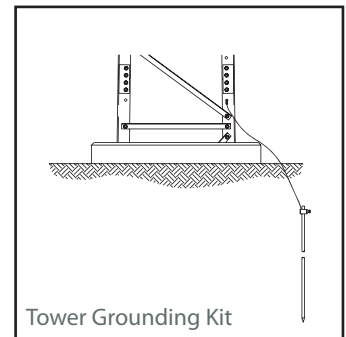
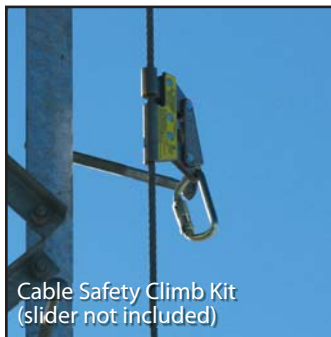

Accessory:	H810	S1000	S1100	S1200			
<b>Cable Safety Climb Kits</b> <i>no slider</i>	4.99.0485.050	4.99.0485.050	4.99.0485.050	4.99.0485.050			
<b>Step-Bolt Kit</b> <i>leg mounted</i>	4.98.0100.050	4.98.1000.050	4.98.1100.050	4.98.1200.050			
<b>Anti-Climb Shield Kits</b>	4.92.0001.012	4.92.0001.213	4.92.0001.213	4.92.0001.213			
<b>Tower Grounding Kit</b> <i>basic, single leg</i>	4.91.0103.000	4.91.0103.003	4.91.0103.003	4.91.0103.003			

For more SuperTitan Accessories and Replacement Parts, see pages 61 to 76.

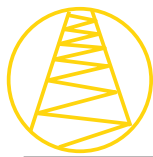

Model Designation:		S100	S200	S300	S400	S500	S600	H700
Knocked-down Part Number:		5.94.0100.060	5.94.0200.060	5.94.0300.060	5.94.0400.060	5.94.0500.060	5.94.0600.060	5.94.H700.060
Assembled Part Number:		5.95.0100.060	5.95.0200.060	5.95.0300.060	5.95.0400.060	5.95.0500.060	5.95.0600.060	5.95.H700.060
<p><i>Includes anchor material for concrete foundation, splice hardware, and pipe anchor brackets for antenna mounting pipe (pipe sold separately on page 68).</i></p> <p><i>Models S100 to H700 use a 5" embedment section as the anchor for concrete.</i></p> <p><i>Knocked-down towers reduce shipping cost in comparison with pre-assembled.</i></p>								
Allowable antenna area in ft <sup>2</sup> *	EIA 222-F 70/90/100 mph wind no ice	Round: 21/3/-- Flat: 15/2/--	Round: 40/15/8 Flat: 28/10/5	Round: 60/28/17 Flat: 42/20/12	Round: 70/30/19 Flat: 50/21/13	Round: 80/33/21 Flat: 57/23/15	Round: 100/40/23 Flat: 71/28/16	Round: 103/47/30 Flat: 73/33/21
	EIA Rev.G Class 1 90/105/120 mph wind 3/4" ice	Round: 14/4/-- Flat: 9/3/--	Round: 28/14/6 Flat: 19/9/4	Round: 50/30/16 Flat: 33/20/11	Round: 56/32/16 Flat: 37/21/11	Round: 82/50/32 Flat: 55/33/21	Round: 122/80/50 Flat: 81/53/33	Round: 126/76/46 Flat: 84/51/31
	EIA Rev.G Class 2 90/105/120 mph wind 3/4" ice	Round: 10/--/-- Flat: 7/--/--	Round: 22/10/2 Flat: 15/7/1	Round: 42/22/10 Flat: 28/15/7	Round: 46/24/12 Flat: 31/16/8	Round: 66/40/24 Flat: 44/27/16	Round: 102/62/38 Flat: 68/41/25	Round: 102/58/36 Flat: 68/39/24
Knocked-down Towers	L"xW"xH"	133x48x24	133x48x25	133x48x25	133x48x25	133x48x25	133x48x26	133x48x30
Assembled Towers	L"xW"xH"	133x60x37	133x75x40	133x75x43	133x75x46	133x75x49	133x87x52	133x90x52
Shipping Weight (lbs)		1,633	1,763	1,888	2,010	2,147	2,360	2,784

\*Assumptions: Projected areas (PA) shown are bare; a 1.5 multiplier used for iced area; loads centrally located and balanced at tower top; considers step-pegs, safety cable, and one 1/2" tx line per 10 sq.ft.; "--" indicates tower failure. \*Round antennas include omnis, dipoles, dishes with radomes, etc. Antennas where wind hits a round surface. Flat Antennas include flat panels, dishes without radomes and cameras, where wind hits a flat surface.

## Common Accessories

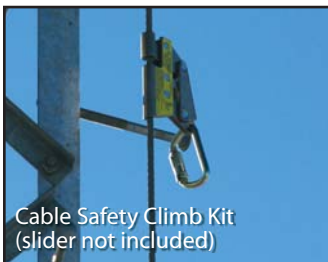

Cable Safety Climb Kit (slider not included)



Step-Bolt Kit



Anti-Climb Shield Kit

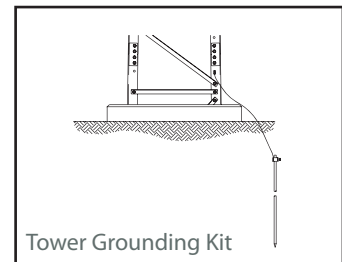

Tower Grounding Kit

Accessory:	S100	S200	S300	S400	S500	S600	H700
<b>Cable Safety Climb Kits</b> <i>no slider</i>	4.99.0485.100	4.99.0485.100	4.99.0485.100	4.99.0485.100	4.99.0485.100	4.99.0485.100	4.99.0485.100
<b>Step-Bolt Kit</b> <i>leg mounted</i>	4.98.0100.060	4.98.0100.060	4.98.0100.060	4.98.0100.060	4.98.0100.060	4.98.0100.060	4.98.0100.060
<b>Anti-Climb Shield Kits</b>	4.92.0001.006	4.92.0001.007	4.92.0001.008	4.92.0001.009	4.92.0001.010	4.92.0001.011	4.92.0001.012
<b>Tower Grounding Kit</b> <i>basic, single leg</i>	4.91.0103.000	4.91.0103.000	4.91.0103.000	4.91.0103.000	4.91.0103.000	4.91.0103.000	4.91.0103.000

For more SuperTitan Accessories and Replacement Parts, see pages 61 to 76.

Model Designation:		H710	S900	S910	S1000	S1010	S1100
Knocked-down Part Number:		5.94.H710.060	5.94.0900.060	5.94.0910.060	5.94.1000.060	5.94.1010.060	5.94.1100.060
Assembled Part Number:		5.95.H710.060	N/A	N/A	N/A	N/A	N/A
<p><i>Includes anchor material for concrete foundation, splice hardware, and pipe anchor brackets for antenna mounting pipe (pipe sold separately on page 68).</i></p> <p><i>Model H710 uses a 5' embedment section as the anchor for concrete; models S900 to S1100 use base feet and tie-rods for concrete foundation.</i></p> <p><i>Knocked-down towers reduce shipping cost in comparison with pre-assembled.</i></p>							
Allowable antenna area in ft <sup>2</sup> *	EIA 222-F 70/90/100 mph wind no ice	Round: 162/80/54 Flat: 108/53/36	Round: 164/86/62 Flat: 109/57/41	Round: 198/112/88 Flat: 132/75/58	Round: 182/100/78 Flat: 121/66/52	Round: 350/174/130 Flat: 233/116/86	Round: 410/212/160 Flat: 273/141/106
	EIA Rev.G Class 1 90/105/120 mph wind 3/4" ice	Round: 126/76/46 Flat: 84/51/31	Round: 152/106/76 Flat: 101/71/51	Round: 152/106/76 Flat: 101/71/51	Round: 262/176/120 Flat: 175/117/80	Round: 262/176/120 Flat: 175/117/80	Round: 264/184/130 Flat: 176/123/87
	EIA Rev.G Class 2 90/105/120 mph wind 3/4" ice	Round: 102/58/36 Flat: 68/39/24	Round: 130/90/64 Flat: 87/60/43	Round: 130/90/64 Flat: 87/60/43	Round: 220/144/90 Flat: 147/96/60	Round: 220/144/90 Flat: 147/96/60	Round: 224/154/108 Flat: 149/103/72
Knocked-down Towers	L"xW"xH"	133x48x30	133x48x48	133x48x48	133x48x48	133x48x48	133x48x48
Assembled Towers	L"xW"xH"	133x90x52	N/A	N/A	N/A	N/A	N/A
Shipping Weight (lbs)		2,831	4,343	4,390	4,790	4,837	5,142





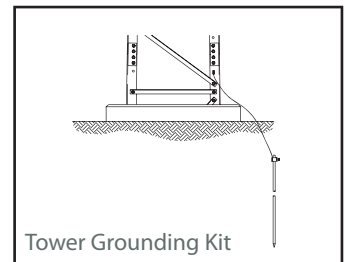
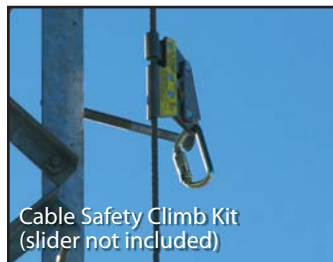

\*Assumptions: Projected areas (PA) shown are bare; a 1.5 multiplier used for iced area; loads centrally located and balanced at tower top; considers step-pegs, safety cable, and one 1/2" tx line per 10 sq.ft.; "-" indicates tower failure.  
 \*\*Round antennas include omnis, dipoles, dishes with radomes, etc. Antennas where wind hits a round surface. Flat Antennas include flat panels, dishes without radomes and cameras, where wind hits a flat surface.

## Common Accessories

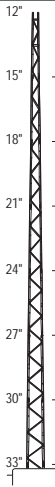

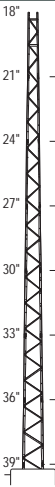
Accessory:	H710	S900	S910	S1000	S1010	S1100
<b>Cable Safety Climb Kits</b> <i>no slider</i>	4.99.0485.100	4.99.0485.100	4.99.0485.100	4.99.0485.100	4.99.0485.100	4.99.0485.100
<b>Step-Bolt Kit</b> <i>leg mounted</i>	4.98.0100.060	4.98.S900.060	4.98.S900.060	4.98.1000.060	4.98.1000.060	4.98.1100.060
<b>Anti-Climb Shield Kits</b>	4.92.0001.012	4.92.0001.213	4.92.0001.213	4.92.0001.213	4.92.0001.213	4.92.0001.213
<b>Tower Grounding Kit</b> <i>basic, single leg</i>	4.91.0103.000	4.91.0103.003	4.91.0103.003	4.91.0103.003	4.91.0103.003	4.91.0103.003

For more SuperTitan Accessories and Replacement Parts, see pages 61 to 76.

Model Designation:	S100	S200	S300	S400	S500	S600	H600	
Knocked-down Part Number:	5.94.0100.070	5.94.0200.070	5.94.0300.070	5.94.0400.070	5.94.0500.070	5.94.0600.070	5.94.H600.070	
Assembled Part Number:	5.95.0100.070	5.95.0200.070	5.95.0300.070	5.95.0400.070	5.95.0500.070	5.95.0600.070	5.95.H600.070	
Includes anchor material for concrete foundation, splice hardware, and pipe anchor brackets for antenna mounting pipe (pipe sold separately on page 68). Models S100 to H600 use a 5' embedment section as the anchor for concrete. Knocked-down towers reduce shipping cost in comparison with pre-assembled.								
Allowable antenna area in ft <sup>2</sup> *	EIA 222-F 70/90/100 mph wind no ice	Round: 20/1/-- Flat: 14/--/--	Round: 36/13/4 Flat: 24/9/2	Round: 52/16/5 Flat: 34/11/3	Round: 56/17/6 Flat: 37/12/4	Round: 71/24/10 Flat: 47/16/7	Round: 74/30/18 Flat: 49/21/12	Round: 110/48/26 Flat: 73/32/17
	EIA Rev.G Class 1 90/105/120 mph wind 3/4" ice	Round: 14/2/-- Flat: 9/1/--	Round: 26/14/4 Flat: 17/9/3	Round: 38/16/4 Flat: 25/11/3	Round: 52/30/14 Flat: 35/20/9	Round: 78/48/30 Flat: 52/32/20	Round: 88/48/28 Flat: 59/32/19	Round: 88/48/28 Flat: 59/32/19
	EIA Rev.G Class 2 90/105/120 mph wind 3/4" ice	Round: 8/--/-- Flat: 5/--/--	Round: 20/10/-- Flat: 13/7/--	Round: 28/12/-- Flat: 19/8/--	Round: 44/22/10 Flat: 29/15/7	Round: 62/38/20 Flat: 41/25/13	Round: 66/36/16 Flat: 44/24/11	Round: 66/36/16 Flat: 44/24/11
Knocked-down Towers	L"xW"xH"	133x48x25	133x48x25	133x48x25	133x48x25	133x48x26	133x48x27	133x48x30
Assembled Towers	L"xW"xH"	133x75x40	133x75x43	133x75x46	133x75x49	133x75x52	133x84x52	133x84x52
Shipping Weight (lbs)	1,966	2,091	2,219	2,359	2,575	2,752	3,063	

\*Assumptions: Projected areas (PA) shown are bare; a 1.5 multiplier used for iced area; loads centrally located and balanced at tower top; considers step-pegs, safety cable, and one 1/2" tx line per 10 sq.ft.; "--" indicates tower failure.  
\*Round antennas include omnis, dipoles, dishes with radomes, etc. Antennas where wind hits a round surface. Flat Antennas include flat panels, dishes without radomes and cameras, where wind hits a flat surface.

## Common Accessories

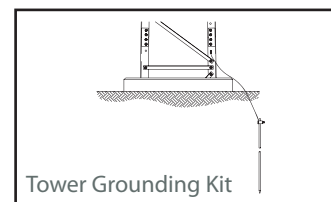
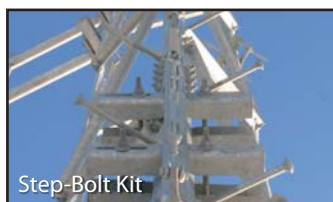
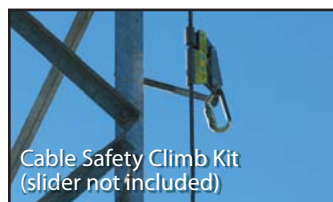

Accessory:	S100	S200	S300	S400	S500	S600	H600
<b>Cable Safety Climb Kits</b> no slider	4.99.0485.100	4.99.0485.100	4.99.0485.100	4.99.0485.100	4.99.0485.100	4.99.0485.100	4.99.0485.100
<b>Step-Bolt Kit</b> leg mounted	4.98.0100.070	4.98.0100.070	4.98.0100.070	4.98.0100.070	4.98.0100.070	4.98.0100.070	4.98.0100.070
<b>Anti-Climb Shield Kits</b>	4.92.0001.007	4.92.0001.008	4.92.0001.009	4.92.0001.010	4.92.0001.011	4.92.0001.012	4.92.0001.012
<b>Tower Grounding Kit</b> basic, single leg	4.91.0103.000	4.91.0103.000	4.91.0103.000	4.91.0103.000	4.91.0103.000	4.91.0103.000	4.91.0103.000

For more SuperTitan Accessories and Replacement Parts, see pages 61 to 76.

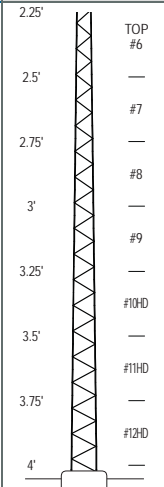
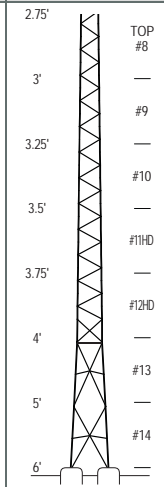
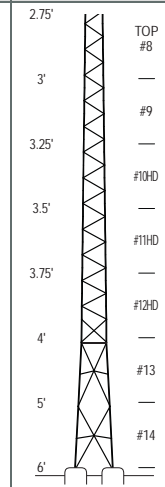
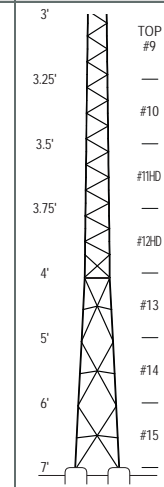
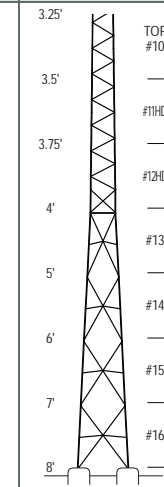
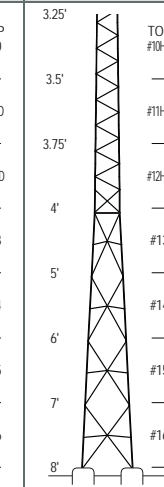
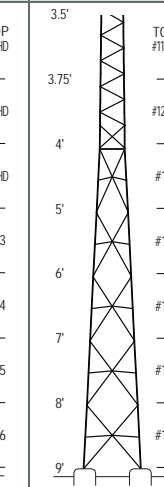
Model Designation:		H610	S800	S810	S900	S1000	S1010	S1100		
Knocked-down Part Number:		5.94.H610.070	5.94.0800.070	5.94.0810.070	5.94.0900.070	5.94.1000.070	5.94.1010.070	5.94.1100.070		
Assembled Part Number:		5.95.H610.070	N/A	N/A	N/A	N/A	N/A	N/A		
<p><i>Includes anchor material for concrete foundation, splice hardware, and pipe anchor brackets for antenna mounting pipe (pipe sold separately on page 68).</i></p> <p><i>Model H610 uses a 5' embedment section as the anchor for concrete; models S800 to S1100 use base feet and tie-rods for concrete foundation.</i></p> <p><i>Knocked-down towers reduce shipping cost in comparison with pre-assembled.</i></p>										
		Allowable antenna area in ft <sup>2</sup> *	EIA 222-F 70/90/100 mph wind no ice	Round: 120/54/32 Flat: 81/36/21	Round: 144/64/42 Flat: 96/42/28	Round: 150/70/46 Flat: 100/46/30	Round: 160/79/60 Flat: 106/52/40	Round: 176/96/76 Flat: 117/64/50	Round: 306/160/120 Flat: 204/106/80	Round: 340/172/126 Flat: 226/114/84
			EIA Rev.G Class 1 90/105/120 mph wind 3/4" ice	Round: 88/48/28 Flat: 59/32/19	Round: 140/92/56 Flat: 93/61/37	Round: 140/92/56 Flat: 93/61/37	Round: 146/102/74 Flat: 97/68/49	Round: 234/150/96 Flat: 156/100/64	Round: 234/150/96 Flat: 156/100/64	Round: 254/176/116 Flat: 169/117/77
			EIA Rev.G Class 2 90/105/120 mph wind 3/4" ice	Round: 66/36/16 Flat: 44/24/11	Round: 116/74/46 Flat: 77/49/31	Round: 116/74/46 Flat: 77/49/31	Round: 124/86/60 Flat: 83/57/40	Round: 194/120/72 Flat: 129/80/48	Round: 194/120/72 Flat: 129/80/48	Round: 216/144/88 Flat: 144/96/59
		Knocked-down Towers	L"xW"xH"	133x48x30	133x48x48	133x48x48	133x48x48	133x48x48	133x48x48	133x48x48
		Assembled Towers	L"xW"xH"	N/A	N/A	N/A	N/A	N/A	N/A	N/A
		Shipping Weight (lbs)		3,110	4,658	4,705	5,109	5,573	5,620	5,990

\*Assumptions: Projected areas (PA) shown are bare; a 1.5 multiplier used for iced area; loads centrally located and balanced at tower top; considers step-pegs, safety cable, and one 1/2" tx line per 10 sq.ft.; "-" indicates tower failure.  
 \*Round antennas include omnis, dipoles, dishes with radomes, etc. Antennas where wind hits a round surface. Flat Antennas include flat panels, dishes without radomes and cameras, where wind hits a flat surface.

## Common Accessories

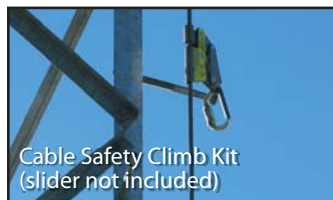

Accessory:	H610	S800	S810	S900	S1000	S1010	S1100
<b>Cable Safety Climb Kits</b> <i>no slider</i>	4.99.0485.100	4.99.0485.100	4.99.0485.100	4.99.0485.100	4.99.0485.100	4.99.0485.100	4.99.0485.100
<b>Step-Bolt Kit</b> <i>leg mounted</i>	4.98.0100.070	4.98.S800.070	4.98.S800.070	4.98.S900.070	4.98.1000.070	4.98.1000.070	4.98.1100.070
<b>Anti-Climb Shield Kits</b>	4.92.0001.012	4.92.0001.213	4.92.0001.213	4.92.0001.213	4.92.0001.213	4.92.0001.213	4.92.0001.213
<b>Tower Grounding Kit</b> <i>basic, single leg</i>	4.91.0103.000	4.91.0103.003	4.91.0103.003	4.91.0103.003	4.91.0103.003	4.91.0103.003	4.91.0103.003

For more SuperTitan Accessories and Replacement Parts, see pages 61 to 76.

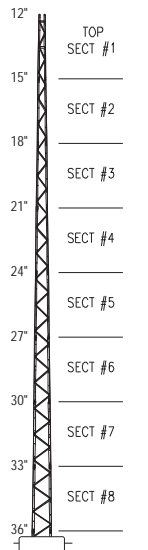
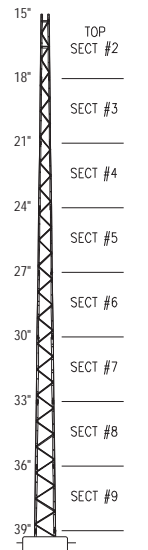
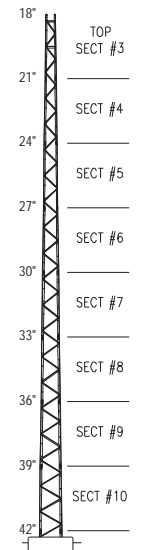
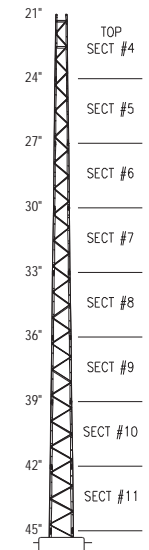
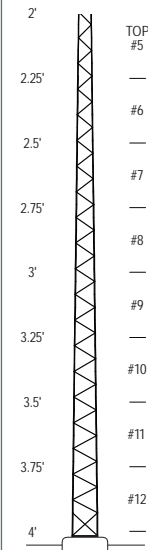
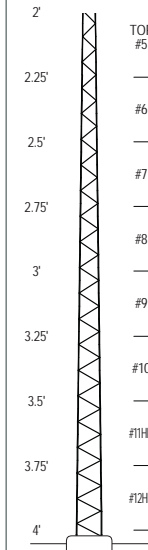
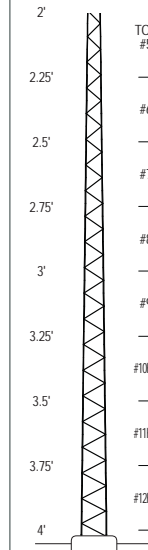

Model Designation:		S100	S200	S300	S400	S500	H500	H510
Knocked-down Part Number:		5.94.0100.080	5.94.0200.080	5.94.0300.080	5.94.0400.080	5.94.0500.080	5.94.H500.080	5.94.H510.080
Assembled Part Number:		5.95.0100.080	5.95.0200.080	5.95.0300.080	5.95.0400.080	5.95.0500.080	5.95.H500.080	5.95.H510.080
<p><i>Includes anchor material for concrete foundation, splice hardware, and pipe anchor brackets for antenna mounting pipe (pipe sold separately on page 68).</i></p> <p><i>Models S100 to S510 use a 5' embedment section as the anchor for concrete.</i></p> <p><i>Knocked-down towers reduce shipping cost in comparison with pre-assembled.</i></p>								
Allowable antenna area in ft <sup>2</sup> *	EIA 222-F 70/90/100 mph wind no ice	Round: 19/--/-- Flat: 13/--/--	Round: 34/4/-- Flat: 22/2/--	Round: 38/4/-- Flat: 25/2/--	Round: 50/9/-- Flat: 35/6/--	Round: 55/10/-- Flat: 39/7/--	Round: 74/30/13 Flat: 49/21/9	Round: 90/34/18 Flat: 60/22/12
	EIA Rev.G Class 1 90/105/120 mph wind 3/4" ice	Round: 12/2/-- Flat: 8/1/--	Round: 22/6/-- Flat: 15/4/--	Round: 34/14/2 Flat: 23/9/1	Round: 50/30/14 Flat: 33/20/9	Round: 58/30/14 Flat: 39/20/9	Round: 58/30/14 Flat: 39/20/9	Round: 58/30/14 Flat: 39/20/9
	EIA Rev.G Class 2 90/105/120 mph wind 3/4" ice	Round: 6/--/-- Flat: 4/--/--	Round: 14/--/-- Flat: 9/--/--	Round: 26/10/-- Flat: 17/7/--	Round: 40/20/8 Flat: 27/13/5	Round: 46/20/4 Flat: 31/13/3	Round: 46/20/4 Flat: 31/13/3	Round: 46/20/4 Flat: 31/13/3
Knocked-down Towers	L"xW"xH"	133x48x33	133x48x34	133x48x34	133x48x34	133x48x35	133x48x35	133x48x35
Assembled Towers	L"xW"xH"	133x75x43	133x75x46	133x75x49	133x75x52	133x86x55	133x86x55	133x86x55
Shipping Weight (lbs)		2,294	2,422	2,568	2,787	2,967	3,278	3,325

\*Assumptions: Projected areas (PA) shown are bare; a 1.5 multiplier used for iced area; loads centrally located and balanced at tower top; considers step-pegs, safety cable, and one 1/2" tx line per 10 sq.ft.; "--" indicates tower failure.  
 \*Round antennas include omnis, dipoles, dishes with radomes, etc. Antennas where wind hits a round surface. Flat Antennas include flat panels, dishes without radomes and cameras, where wind hits a flat surface.

## Common Accessories

Accessory:	S100	S200	S300	S400	S500	H500	H510
<b>Cable Safety Climb Kits</b> <i>no slider</i>	4.99.0485.100	4.99.0485.100	4.99.0485.100	4.99.0485.100	4.99.0485.100	4.99.0485.100	4.99.0485.100
<b>Step-Bolt Kit</b> <i>leg mounted</i>	4.98.0100.080	4.98.0100.080	4.98.0100.080	4.98.0100.080	4.98.0100.080	4.98.0100.080	4.98.0100.080
<b>Anti-Climb Shield Kits</b>	4.92.0001.008	4.92.0001.009	4.92.0001.010	4.92.0001.011	4.92.0001.012	4.92.0001.012	4.92.0001.012
<b>Tower Grounding Kit</b> <i>basic, single leg</i>	4.91.0103.000	4.91.0103.000	4.91.0103.000	4.91.0103.000	4.91.0103.000	4.91.0103.000	4.91.0103.000

For more SuperTitan Accessories and Replacement Parts, see pages 61 to 76.

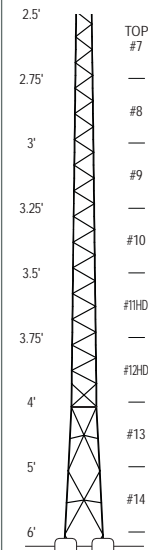
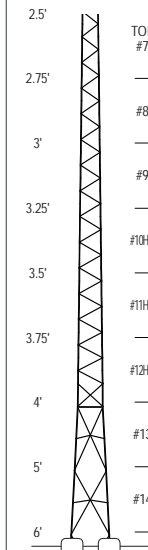
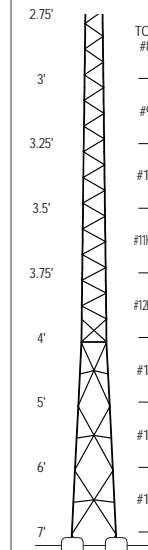
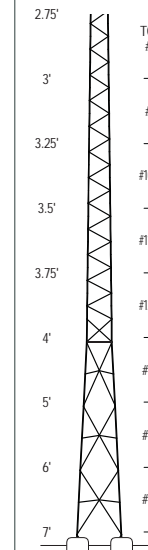
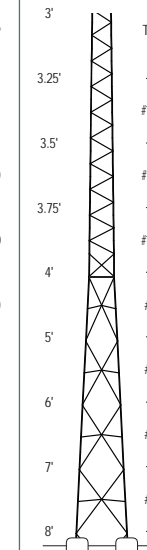
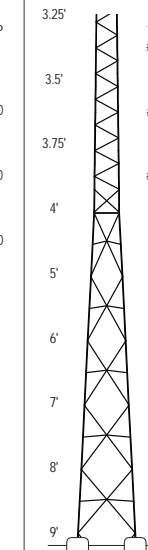
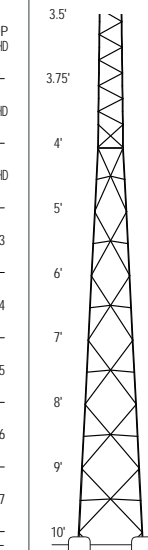

Model Designation:	S700	S710	S800	S810	S910	S1010	S1100	
Knocked-down Part Number:	5.94.0700.080	5.94.0710.080	5.94.0800.080	5.94.0810.080	5.94.0910.080	5.94.1010.080	5.94.1100.080	
Assembled Part Number:	N/A	N/A	N/A	N/A	N/A	N/A	N/A	
<p><i>Includes anchor material for concrete foundation, splice hardware, and pipe anchor brackets for antenna mounting pipe (pipe sold separately on page 68).</i></p> <p><i>Models H700 to S710 use a 5' embedment section as the anchor for concrete; models S800 to S1100 use base feet and tie-rods for concrete foundation.</i></p> <p><i>Knocked-down towers reduce shipping cost in comparison with pre-assembled.</i></p>								
Allowable antenna area in ft <sup>2</sup> *	EIA 222-F 70/90/100 mph wind no ice	Round: 124/50/30 Flat: 82/33/20	Round: 132/52/30 Flat: 88/34/20	Round: 142/64/36 Flat: 94/42/24	Round: 170/90/66 Flat: 113/60/44	Round: 186/104/82 Flat: 124/69/54	Round: 280/140/100 Flat: 186/93/66	Round: 342/180/134 Flat: 228/120/89
	EIA Rev.G Class 1 90/105/120 mph wind 3/4" ice	Round: 114/62/34 Flat: 76/41/23	Round: 114/62/34 Flat: 76/41/23	Round: 136/88/50 Flat: 91/59/33	Round: 136/88/50 Flat: 91/59/33	Round: 142/98/60 Flat: 95/65/40	Round: 210/128/74 Flat: 140/85/49	Round: 246/170/108 Flat: 164/113/72
	EIA Rev.G Class 2 90/105/120 mph wind 3/4" ice	Round: 88/46/24 Flat: 59/31/16	Round: 88/46/24 Flat: 59/31/16	Round: 112/66/36 Flat: 75/44/24	Round: 112/66/36 Flat: 75/44/24	Round: 120/80/46 Flat: 80/53/31	Round: 170/98/52 Flat: 113/65/35	Round: 210/136/82 Flat: 140/91/55
Knocked-down Towers	L"xW"xH"	133x48x48	133x48x48	133x48x50	133x48x50	133x48x50	133x48x54	133x96x40
Assembled Towers	L"xW"xH"	N/A	N/A	N/A	N/A	N/A	N/A	N/A
Shipping Weight (lbs)	4,963	5,010	5,424	5,471	5,892	6,421	7,038	

\*Assumptions: Projected areas (PA) shown are bare; a 1.5 multiplier used for iced area; loads centrally located and balanced at tower top; considers step-pegs, safety cable, and one 1/2" tx line per 10 sq.ft.; "--" indicates tower failure.  
 \*Round antennas include omnis, dipoles, dishes with radomes, etc. Antennas where wind hits a round surface. Flat Antennas include flat panels, dishes without radomes and cameras, where wind hits a flat surface.

## Common Accessories

Accessory:	S700	S710	S800	S810	S910	S1010	S1100
<b>Cable Safety Climb Kits</b> <i>no slider</i>	4.99.0485.100	4.99.0485.100	4.99.0485.100	4.99.0485.100	4.99.0485.100	4.99.0485.100	4.99.0485.100
<b>Step-Bolt Kit</b> <i>leg mounted</i>	4.98.S700.080	4.98.S700.080	4.98.S800.080	4.98.S800.080	4.98.S900.080	4.98.1000.080	4.98.1100.080
<b>Anti-Climb Shield Kits</b>	4.92.0001.213	4.92.0001.213	4.92.0001.213	4.92.0001.213	4.92.0001.213	4.92.0001.213	4.92.0001.213
<b>Tower Grounding Kit</b> <i>basic, single leg</i>	4.91.0103.003	4.91.0103.003	4.91.0103.003	4.91.0103.003	4.91.0103.003	4.91.0103.003	4.91.0103.003

For more SuperTitan Accessories and Replacement Parts, see pages 61 to 76.

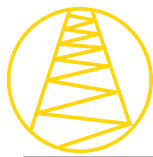

Model Designation:	S100	S200	S300	S400	H400	H410	S600	
Knocked-down Part Number:	5.94.0100.090	5.94.0200.090	5.94.0300.090	5.94.0400.090	5.94.H400.090	5.94.H410.090	5.94.0600.090	
Assembled Part Number:	5.95.0100.090	5.95.0200.090	5.95.0300.090	5.95.0400.090	5.95.H400.090	5.95.H410.090	N/A	
Includes anchor material for concrete foundation, splice hardware, and pipe anchor brackets for antenna mounting pipe (pipe sold separately on page 68).  Models S100 to H410 use a 5' embedment section as the anchor for concrete; model S600 uses base feet and tie-rods.  Knocked-down towers reduce shipping cost in comparison with pre-assembled.								
Allowable antenna area in ft <sup>2</sup> *	EIA 222-F 70/90/100 mph wind no ice	Round: 17/--/-- Flat: 12/--/--	Round: 21/--/-- Flat: 15/--/--	Round: 31/--/-- Flat: 22/--/--	Round: 32/--/-- Flat: 22/--/--	Round: 51/13/1 Flat: 36/9/--	Round: 64/20/4 Flat: 42/13/2	Round: 106/42/20 Flat: 70/28/13
	EIA Rev.G Class 1 90/105/120 mph wind 3/4" ice	Round: 10/--/-- Flat: 7/--/--	Round: 14/--/-- Flat: 9/--/--	Round: 30/14/-- Flat: 20/9/--	Round: 42/16/-- Flat: 28/11/--	Round: 42/16/-- Flat: 28/11/--	Round: 42/16/-- Flat: 28/11/--	Round: 78/42/18 Flat: 52/28/12
	EIA Rev.G Class 2 90/105/120 mph wind 3/4" ice	Round: 4/--/-- Flat: 3/--/--	Round: 4/--/-- Flat: 3/--/--	Round: 24/8/-- Flat: 16/5/--	Round: 30/8/-- Flat: 20/5/--	Round: 30/8/-- Flat: 20/5/--	Round: 30/8/-- Flat: 20/5/--	Round: 58/30/8 Flat: 39/20/5
Knocked-down Towers	L"xW"xH"	133x48x34	133x48x34	133x48x35	133x48x35	133x96x44	133x96x44	133x48x58
Assembled Towers	L"xW"xH"	133x75x46	133x75x49	133x75x52	133x75x55	133x75x55	133x75x55	N/A
Shipping Weight (lbs)	2,625	2,771	2,996	3,179	3,565	3,226	5,242	

\*Assumptions: Projected areas (PA) shown are bare; a 1.5 multiplier used for iced area; loads centrally located and balanced at tower top; considers step-pegs, safety cable, and one 1/2" tx line per 10 sq.ft.; "--" indicates tower failure.  
\*Round antennas include omnis, dipoles, dishes with radomes, etc. Antennas where wind hits a round surface. Flat Antennas include flat panels, dishes without radomes and cameras, where wind hits a flat surface.

## Common Accessories

Accessory:	S100	S200	S300	S400	H400	H410	S600
<b>Cable Safety Climb Kits</b> <i>no slider</i>	4.99.0485.100	4.99.0485.100	4.99.0485.100	4.99.0485.100	4.99.0485.100	4.99.0485.100	4.99.0485.100
<b>Step-Bolt Kit</b> <i>leg mounted</i>	4.98.0100.090	4.98.0100.090	4.98.0100.090	4.98.0100.090	4.98.0100.090	4.98.0100.090	4.98.S600.090
<b>Anti-Climb Shield Kits</b>	4.92.0001.009	4.92.0001.010	4.92.0001.011	4.92.0001.012	4.92.0001.012	4.92.0001.012	4.92.0001.213
<b>Tower Grounding Kit</b> <i>basic, single leg</i>	4.91.0103.000	4.91.0103.000	4.91.0103.000	4.91.0103.000	4.91.0103.000	4.91.0103.000	4.91.0103.003

For more SuperTitan Accessories and Replacement Parts, see pages 61 to 76.

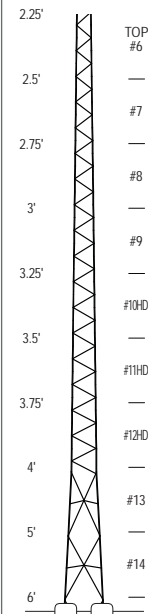
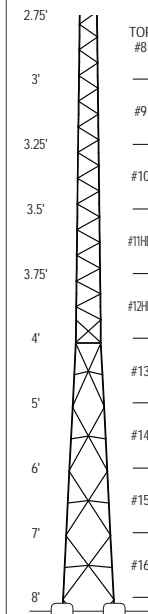
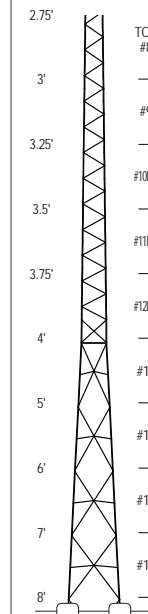
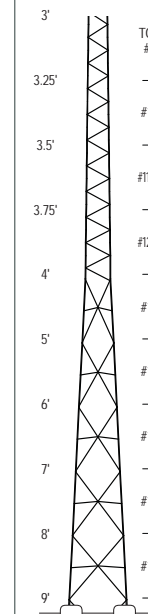
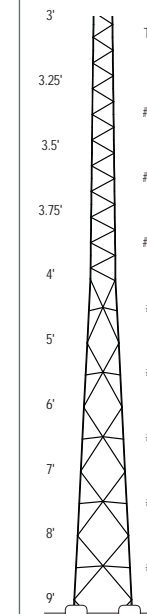
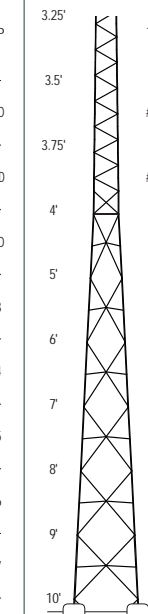
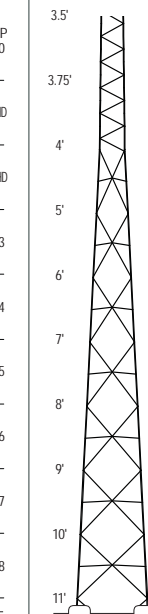
Model Designation:	S610	S800	S810	S900	S910	S1000	S1100	
Knocked-down Part Number:	5.94.0610.090	5.94.0800.090	5.94.0810.090	5.94.0900.090	5.94.0910.090	5.94.1000.090	5.94.1100.090	
Assembled Part Number:	N/A	N/A	N/A	N/A	N/A	N/A	N/A	
<p><i>Includes anchor material for concrete foundation, splice hardware, and pipe anchor brackets for antenna mounting pipe (pipe sold separately on page 68).</i></p> <p><i>Models S610 to S1100 use base feet and tie-rods for concrete foundation.</i></p> <p><i>Knocked-down towers reduce shipping cost in comparison with pre-assembled.</i></p>								
Allowable antenna area in ft <sup>2</sup> *	EIA 222-F 70/90/100 mph wind no ice	Round: 108/44/26 Flat: 72/29/17	Round: 136/58/36 Flat: 90/38/24	Round: 160/84/54 Flat: 106/56/36	Round: 150/72/52 Flat: 100/48/34	Round: 180/102/69 Flat: 120/68/46	Round: 164/92/68 Flat: 109/61/45	Round: 330/162/116 Flat: 220/108/77
	EIA Rev.G Class 1 90/105/120 mph wind 3/4" ice	Round: 78/42/18 Flat: 52/28/12	Round: 130/70/38 Flat: 87/47/25	Round: 130/70/38 Flat: 87/47/25	Round: 138/88/48 Flat: 92/59/32	Round: 138/88/48 Flat: 92/59/32	Round: 200/120/68 Flat: 133/80/45	Round: 240/162/104 Flat: 160/108/69
	EIA Rev.G Class 2 90/105/120 mph wind 3/4" ice	Round: 58/30/8 Flat: 39/20/5	Round: 102/52/26 Flat: 68/35/17	Round: 102/52/26 Flat: 68/35/17	Round: 118/64/32 Flat: 79/43/21	Round: 118/64/32 Flat: 79/43/21	Round: 162/92/50 Flat: 108/61/33	Round: 204/130/78 Flat: 136/87/52
Knocked-down Towers	L"xW"xH"	133x48x58	133x48x58	133x48x58	133x96x40	133x96x40	133x96x40	133x96x40
Assembled Towers	L"xW"xH"	N/A	N/A	N/A	N/A	N/A	N/A	N/A
Shipping Weight (lbs)	5,289	6,207	6,254	6,815	6,862	7,469	8,027	

\*Assumptions: Projected areas (PA) shown are bare; a 1.5 multiplier used for iced area; loads centrally located and balanced at tower top; considers step-pegs, safety cable, and one 1/2" tx line per 10 sq.ft.; "-" indicates tower failure.  
 \*Round antennas include omnis, dipoles, dishes with radomes, etc. Antennas where wind hits a round surface. Flat Antennas include flat panels, dishes without radomes and cameras, where wind hits a flat surface.

## Common Accessories

Accessory:	S610	S800	S810	S900	S910	S1000	S1100
<b>Cable Safety Climb Kits</b> <i>no slider</i>	4.99.0485.100	4.99.0485.100	4.99.0485.100	4.99.0485.100	4.99.0485.100	4.99.0485.100	4.99.0485.100
<b>Step-Bolt Kit</b> <i>leg mounted</i>	4.98.S600.090	4.98.S800.090	4.98.S800.090	4.98.S900.090	4.98.S900.090	4.98.1000.090	4.98.1100.090
<b>Anti-Climb Shield Kits</b>	4.92.0001.213	4.92.0001.213	4.92.0001.213	4.92.0001.213	4.92.0001.213	4.92.0001.213	4.92.0001.213
<b>Tower Grounding Kit</b> <i>basic, single leg</i>	4.91.0103.003	4.91.0103.003	4.91.0103.003	4.91.0103.003	4.91.0103.003	4.91.0103.003	4.91.0103.003

For more SuperTitan Accessories and Replacement Parts, see pages 61 to 76.

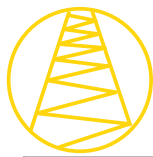

Model Designation:	S100	S200	S300	H300	H310	S500	S510	
Knocked-down Part Number:	5.94.0100.100	5.94.0200.100	5.94.0300.100	5.94.H300.100	5.94.H310.100	5.94.0500.100	5.94.0510.100	
Assembled Part Number:	5.95.0100.100	5.95.0200.100	5.95.0300.100	5.95.H300.100	5.95.H310.100	N/A	N/A	
<p><i>Includes anchor material for concrete foundation, splice hardware, and pipe anchor brackets for antenna mounting pipe (pipe sold separately on page 68).</i></p> <p><i>Models S100 to H310 use a 5' embedment section as the anchor for concrete; models S500 to S510 use base feet and tie-rods for concrete foundation.</i></p> <p><i>Knocked-down towers reduce shipping cost in comparison with pre-assembled.</i></p>								
Allowable antenna area in ft <sup>2</sup> *	EIA 222-F 70/90/100 mph wind no ice	Round: 10/--/-- Flat: 7/--/--	Round: 19/--/-- Flat: 13/--/--	Round: 20/--/-- Flat: 14/--/--	Round: 31/5/-- Flat: 20/3/--	Round: 44/7/-- Flat: 29/4/--	Round: 70/24/9 Flat: 46/16/6	Round: 78/24/10 Flat: 52/16/6
	EIA Rev.G Class 1 90/105/120 mph wind 3/4" ice	Round: 2/--/-- Flat: 1/--/--	Round: 12/--/-- Flat: 8/--/--	Round: 28/6/-- Flat: 19/4/--	Round: 28/6/-- Flat: 19/4/--	Round: 28/6/-- Flat: 19/4/--	Round: 52/26/6 Flat: 35/17/4	Round: 52/26/6 Flat: 35/17/4
	EIA Rev.G Class 2 90/105/120 mph wind 3/4" ice	Round: --/--/-- Flat: --/--/--	Round: 2/--/-- Flat: 1/--/--	Round: 14/--/-- Flat: 9/--/--	Round: 14/--/-- Flat: 9/--/--	Round: 14/--/-- Flat: 9/--/--	Round: 40/14/-- Flat: 27/9/--	Round: 40/14/-- Flat: 27/9/--
Knocked-down Towers	L"xW"xH"	133x48x34	133x48x35	133x48x42	133x48x45	133x48x45	133x48x55	133x48x55
Assembled Towers	L"xW"xH"	133x75x49	133x75x52	133x75x55	133x75x55	133x75x55	N/A	N/A
Shipping Weight (lbs)	2,974	3,199	3,463	3,774	3,821	5,457	5,504	

\*Assumptions: Projected areas (PA) shown are bare; a 1.5 multiplier used for iced area; loads centrally located and balanced at tower top; considers step-pegs, safety cable, and one 1/2" tx line per 10 sq.ft.; "--" indicates tower failure.  
 \*Round antennas include omnis, dipoles, dishes with radomes, etc. Antennas where wind hits a round surface. Flat Antennas include flat panels, dishes without radomes and cameras, where wind hits a flat surface.

## Common Accessories

Accessory:	S100	S200	S300	H300	H310	S500	S510
<b>Cable Safety Climb Kits</b> <i>no slider</i>	4.99.0485.100	4.99.0485.100	4.99.0485.100	4.99.0485.100	4.99.0485.100	4.99.0485.100	4.99.0485.100
<b>Step-Bolt Kit</b> <i>leg mounted</i>	4.98.0100.100	4.98.0100.100	4.98.0100.100	4.98.0100.100	4.98.0100.100	4.98.S500.100	4.98.S500.100
<b>Anti-Climb Shield Kits</b>	4.92.0001.010	4.92.0001.011	4.92.0001.012	4.92.0001.012	4.92.0001.012	4.92.0001.213	4.92.0001.213
<b>Tower Grounding Kit</b> <i>basic, single leg</i>	4.91.0103.000	4.91.0103.000	4.91.0103.000	4.91.0103.000	4.91.0103.000	4.91.0103.003	4.91.0103.003

For more SuperTitan Accessories and Replacement Parts, see pages 61 to 76.

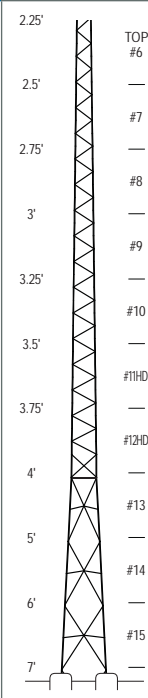
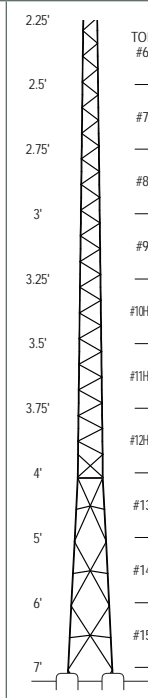
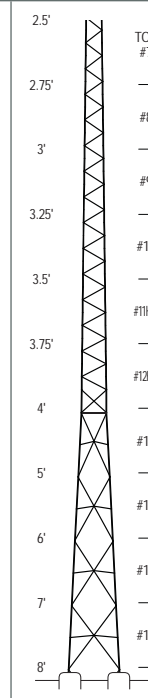
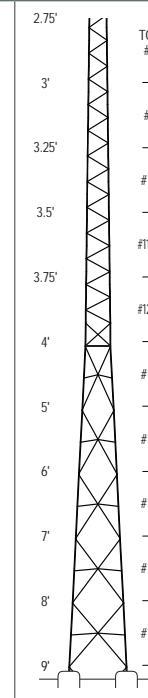
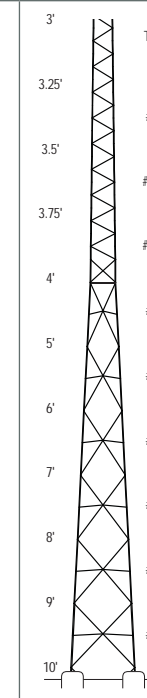
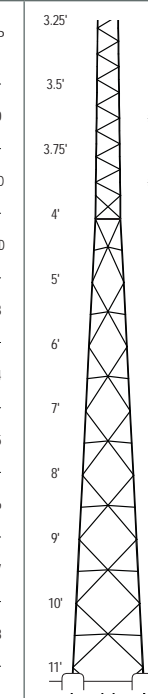
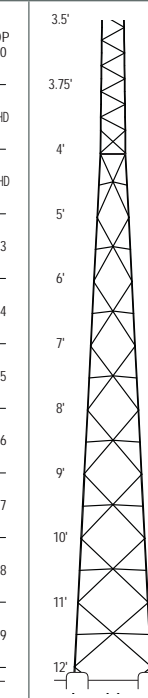
Model Designation:	S600	S610	S700	S800	S900	S1000	S1100		
Knocked-down Part Number:	5.94.0600.100	5.94.0610.100	5.94.0700.100	5.94.0800.100	5.94.0900.100	5.94.1000.100	5.94.1100.100		
Assembled Part Number:	N/A	N/A	N/A	N/A	N/A	N/A	N/A		
<p><i>Includes anchor material for concrete foundation, splice hardware, and pipe anchor brackets for antenna mounting pipe (pipe sold separately on page 68).</i></p> <p><i>Models S600 to S1100 use base feet and tie-rods for concrete foundation.</i></p> <p><i>Knocked-down towers reduce shipping cost in comparison with pre-assembled.</i></p>									
	Allowable antenna area in ft <sup>2</sup> *	EIA 222-F 70/90/100 mph wind no ice	Round: 100/38/14 Flat: 66/25/9	Round: 102/40/22 Flat: 68/26/14	Round: 116/46/24 Flat: 77/30/16	Round: 130/54/32 Flat: 86/36/21	Round: 140/70/50 Flat: 93/46/33	Round: 160/90/66 Flat: 106/60/44	Round: 320/165/116 Flat: 213/110/77
		EIA Rev.G Class 1 90/105/120 mph wind 3/4" ice	Round: 72/36/14 Flat: 48/24/9	Round: 72/36/14 Flat: 48/24/9	Round: 94/46/20 Flat: 63/31/13	Round: 118/58/30 Flat: 79/39/20	Round: 134/82/46 Flat: 89/55/31	Round: 192/114/64 Flat: 128/76/43	Round: 234/156/98 Flat: 156/104/65
		EIA Rev.G Class 2 90/105/120 mph wind 3/4" ice	Round: 52/26/4 Flat: 35/17/3	Round: 52/26/4 Flat: 35/17/3	Round: 68/30/10 Flat: 45/20/7	Round: 88/44/14 Flat: 59/29/9	Round: 114/58/30 Flat: 76/39/20	Round: 154/86/46 Flat: 103/57/31	Round: 198/124/74 Flat: 132/83/49
	Knocked-down Towers	L"xW"xH"	133x48x58	133x48x58	133x48x58	133x96x40	133x96x40	133x96x40	133x96x40
	Assembled Towers	L"xW"xH"	N/A	N/A	N/A	N/A	N/A	N/A	N/A
	Shipping Weight (lbs)	6,008	6,055	6,512	7,130	7,788	8,465	9,024	

\*Assumptions: Projected areas (PA) shown are bare; a 1.5 multiplier used for iced area; loads centrally located and balanced at tower top; considers step-pegs, safety cable, and one 1/2" tx line per 10 sq.ft.; "-" indicates tower failure.  
 \*Round antennas include omnis, dipoles, dishes with radomes, etc. Antennas where wind hits a round surface. Flat Antennas include flat panels, dishes without radomes and cameras, where wind hits a flat surface.

## Common Accessories

Accessory:	S600	S610	S700	S800	S900	S1000	S1100
<b>Cable Safety Climb Kits</b> <i>no slider</i>	4.99.0485.100	4.99.0485.100	4.99.0485.100	4.99.0485.100	4.99.0485.100	4.99.0485.100	4.99.0485.100
<b>Step-Bolt Kit</b> <i>leg mounted</i>	4.98.S600.100	4.98.S600.100	4.98.S700.100	4.98.S800.100	4.98.S900.100	4.98.1000.100	4.98.1100.100
<b>Anti-Climb Shield Kits</b>	4.92.0001.213	4.92.0001.213	4.92.0001.213	4.92.0001.213	4.92.0001.213	4.92.0001.213	4.92.0001.213
<b>Tower Grounding Kit</b> <i>basic, single leg</i>	4.91.0103.003	4.91.0103.003	4.91.0103.003	4.91.0103.003	4.91.0103.003	4.91.0103.003	4.91.0103.003

For more SuperTitan Accessories and Replacement Parts, see pages 61 to 76.

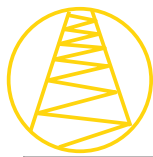

Model Designation:	S100	S200	H200	H210	S400	S410	S500	
Knocked-down Part Number:	5.94.0100.110	5.94.0200.110	5.94.H200.110	5.94.H210.110	5.94.0400.110	5.94.0410.110	5.94.0500.110	
Assembled Part Number:	5.95.0100.110	5.95.0200.110	5.95.H200.110	5.95.H210.110	N/A	N/A	N/A	
Includes anchor material for concrete foundation, splice hardware, and pipe anchor brackets for antenna mounting pipe (pipe sold separately on page 68).  Models S100 to H210 use a 5' embedment section as the anchor for concrete; models S400 to S500 use base feet and tie-rods for concrete foundation.  Knocked-down towers reduce shipping cost in comparison with pre-assembled.								
Allowable antenna area in ft <sup>2</sup> *	EIA 222-F 70/90/100 mph wind no ice	Round: 8/--/-- Flat: 5/--/--	Round: 9/--/-- Flat: 6/--/--	Round: 18/--/-- Flat: 12/--/--	Round: 20/--/-- Flat: 13/--/--	Round: 46/10/-- Flat: 30/7/--	Round: 56/10/-- Flat: 37/7/--	Round: 68/22/6 Flat: 45/14/4
	EIA Rev.G Class 1 90/105/120 mph wind 3/4" ice	Round: --/--/-- Flat: --/--/--	Round: 14/--/-- Flat: 9/--/--	Round: 14/--/-- Flat: 9/--/--	Round: 14/--/-- Flat: 9/--/--	Round: 36/14/-- Flat: 24/9/--	Round: 36/14/-- Flat: 24/9/--	Round: 50/22/2 Flat: 33/15/1
	EIA Rev.G Class 2 90/105/120 mph wind 3/4" ice	Round: --/--/-- Flat: --/--/--	Round: 6/--/-- Flat: 4/--/--	Round: 6/--/-- Flat: 4/--/--	Round: 6/--/-- Flat: 4/--/--	Round: 26/2/-- Flat: 17/1/--	Round: 26/2/-- Flat: 17/1/--	Round: 36/12/-- Flat: 24/8/--
Knocked-down Towers	L"xW"xH"	133x48x42	133x48x42	133x48x45	133x48x45	133x48x57	133x48x57	133x48x49
Assembled Towers	L"xW"xH"	133x75x55	133x75x55	133x75x55	133x75x55	N/A	N/A	N/A
Shipping Weight (lbs)	3,477	3,666	3,977	4,024	5,669	5,716	6,223	



\*Assumptions: Projected areas (PA) shown are bare; a 1.5 multiplier used for iced area; loads centrally located and balanced at tower top; considers step-pegs, safety cable, and one 1/2" tx line per 10 sq.ft.; "--" indicates tower failure.  
\*Round antennas include omnis, dipoles, dishes with radomes, etc. Antennas where wind hits a round surface. Flat Antennas include flat panels, dishes without radomes and cameras, where wind hits a flat surface.

## Common Accessories

Accessory:	S100	S200	H200	H210	S400	S410	S500
<b>Cable Safety Climb Kits</b> <i>no slider</i>	4.99.0485.150	4.99.0485.150	4.99.0485.150	4.99.0485.150	4.99.0485.150	4.99.0485.150	4.99.0485.150
<b>Step-Bolt Kit</b> <i>leg mounted</i>	4.98.0100.110	4.98.0100.110	4.98.0100.110	4.98.0100.110	4.98.S400.110	4.98.S400.110	4.98.S500.110
<b>Anti-Climb Shield Kits</b>	4.92.0001.011	4.92.0001.012	4.92.0001.012	4.92.0001.012	4.92.0001.213	4.92.0001.213	4.92.0001.213

For more SuperTitan Accessories and Replacement Parts, see pages 61 to 76.

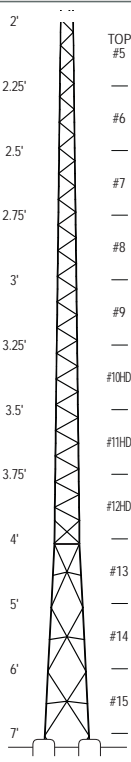
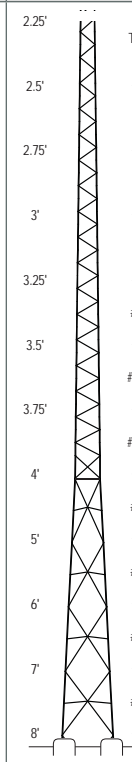
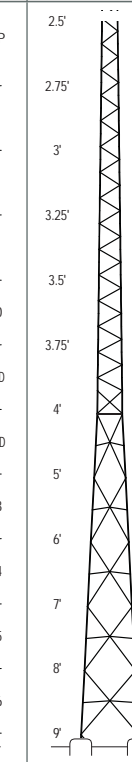
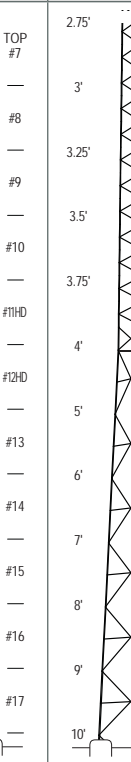

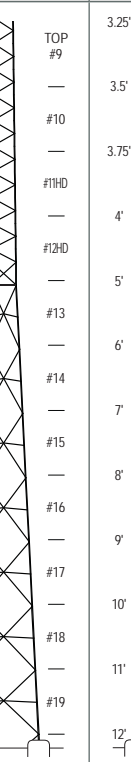
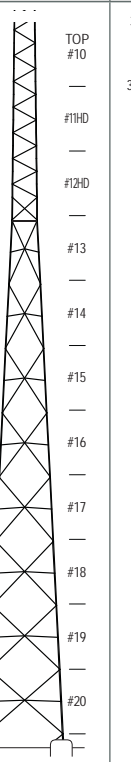
Model Designation:		S510	S600	S700	S800	S900	S1000	S1100
Knocked-down Part Number:		5.94.0510.110	5.94.0600.110	5.94.0700.110	5.94.0800.110	5.94.0900.110	5.94.1000.110	5.94.1100.110
Assembled Part Number:		N/A	N/A	N/A	N/A	N/A	N/A	N/A
<p><i>Includes anchor material for concrete foundation, splice hardware, and pipe anchor brackets for antenna mounting pipe (pipe sold separately on page 68).</i></p> <p><i>Models S510 to S1100 use base feet and tie-rods for concrete foundation.</i></p> <p><i>Knocked-down towers reduce shipping cost in comparison with pre-assembled.</i></p>								
Allowable antenna area in ft <sup>2</sup> *	EIA 222-F 70/90/100 mph wind no ice	Round: 74/22/8 Flat: 49/44/5	Round: 98/32/11 Flat: 65/21/7	Round: 116/44/20 Flat: 77/29/13	Round: 124/54/32 Flat: 82/36/21	Round: 140/70/48 Flat: 93/46/32	Round: 156/86/64 Flat: 109/57/42	Round: 302/140/92 Flat: 201/93/61
	EIA Rev.G Class 1 90/105/120 mph wind 3/4" ice	Round: 50/22/2 Flat: 33/15/1	Round: 66/30/6 Flat: 44/20/4	Round: 86/40/14 Flat: 57/27/9	Round: 11/52/26 Flat: 75/35/17	Round: 132/78/42 Flat: 88/52/28	Round: 186/110/60 Flat: 124/73/40	Round: 228/152/84 Flat: 152/101/56
	EIA Rev.G Class 2 90/105/120 mph wind 3/4" ice	Round: 36/12/-- Flat: 24/8/--	Round: 48/16/-- Flat: 32/11/--	Round: 58/26/-- Flat: 39/17/--	Round: 82/40/14 Flat: 55/27/9	Round: 112/54/28 Flat: 75/36/19	Round: 148/82/46 Flat: 99/55/31	Round: 192/116/54 Flat: 128/77/36
Knocked-down Towers	L"xW"xH"	133x48x49	133x96x40	133x96x40	133x96x40	133x96x40	133x96x40	133x96x48
Assembled Towers	L"xW"xH"	N/A	N/A	N/A	N/A	N/A	N/A	N/A
Shipping Weight (lbs)		6,270	6,866	7,435	8,103	8,777	9,455	10,120

\*Assumptions: Projected areas (PA) shown are bare; a 1.5 multiplier used for iced area; loads centrally located and balanced at tower top; considers step-pegs, safety cable, and one 1/2" tx line per 10 sq.ft.; "--" indicates tower failure.  
\*Round antennas include omnis, dipoles, dishes with radomes, etc. Antennas where wind hits a round surface. Flat Antennas include flat panels, dishes without radomes and cameras, where wind hits a flat surface.

## Common Accessories

Accessory:	S510	S600	S700	S800	S900	S1000	S1100
<b>Cable Safety Climb Kits</b> <i>no slider</i>	4.99.0485.150	4.99.0485.150	4.99.0485.150	4.99.0485.150	4.99.0485.150	4.99.0485.150	4.99.0485.150
<b>Step-Bolt Kit</b> <i>leg mounted</i>	4.98.S500.110	4.98.S600.110	4.98.S700.110	4.98.S800.110	4.98.S900.110	4.98.1000.110	4.98.1100.110
<b>Anti-Climb Shield Kits</b>	4.92.0001.213	4.92.0001.213	4.92.0001.213	4.92.0001.213	4.92.0001.213	4.92.0001.213	4.92.0001.213

For more SuperTitan Accessories and Replacement Parts, see pages 61 to 76.

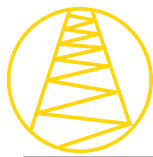

Model Designation:		S100	H100	H110	S300	S310	S400	S410
Knocked-down Part Number:		5.94.0100.120	5.94.H100.120	5.94.H110.120	5.94.0300.120	5.94.0310.120	5.94.0400.120	5.94.0410.120
Assembled Part Number:		5.95.0100.120	5.95.H100.120	5.95.H110.120	N/A	N/A	N/A	N/A
<p><i>Includes anchor material for concrete foundation, splice hardware, and pipe anchor brackets for antenna mounting pipe (pipe sold separately on page 68).</i></p> <p><i>Models S100 to H110 use a 5' embedment section as the anchor for concrete; models S300 to S410 use base feet and tie-rods for concrete foundation.</i></p> <p><i>Knocked-down towers reduce shipping cost in comparison with pre-assembled.</i></p>								
Allowable antenna area in ft <sup>2</sup> *	EIA 222-F 70/90/100 mph wind no ice	Round: --/--/-- Flat: --/--/--	Round: 9/--/-- Flat: 6/--/--	Round: 14/--/-- Flat: 9/--/--	Round: 30/--/-- Flat: 21/--/--	Round: 40/--/-- Flat: 26/--/--	Round: 44/9/-- Flat: 29/6/--	Round: 52/10/-- Flat: 34/7/--
	EIA Rev.G Class 1 90/105/120 mph wind 3/4" ice	Round: --/--/-- Flat: --/--/--	Round: --/--/-- Flat: --/--/--	Round: 6/--/-- Flat: 4/--/--	Round: 22/2/-- Flat: 15/1/--	Round: 22/2/-- Flat: 15/1/--	Round: 32/12/-- Flat: 21/8/--	Round: 32/12/-- Flat: 21/8/--
	EIA Rev.G Class 2 90/105/120 mph wind 3/4" ice	Round: --/--/-- Flat: --/--/--	Round: --/--/-- Flat: --/--/--	Round: --/--/-- Flat: --/--/--	Round: 14/--/-- Flat: 9/--/--	Round: 14/--/-- Flat: 9/--/--	Round: 22/--/-- Flat: 15/--/--	Round: 22/--/-- Flat: 15/--/--
Knocked-down Towers	L"xW"xH"	133x48x50	133x48x53	133x48x53	133x48x57	133x48x57	133x48x63	133x48x63
Assembled Towers	L"xW"xH"	133x75x55	133x75x55	133x75x55	N/A	N/A	N/A	N/A
Shipping Weight (lbs)		3,894	4,180	4,228	5,878	5,925	6,435	6,482

\*Assumptions: Projected areas (PA) shown are bare; a 1.5 multiplier used for iced area; loads centrally located and balanced at tower top; considers step-pegs, safety cable, and one 1/2" tx line per 10 sq.ft.; "--" indicates tower failure.  
 \*Round antennas include omnis, dipoles, dishes with radomes, etc. Antennas where wind hits a round surface. Flat Antennas include flat panels, dishes without radomes and cameras, where wind hits a flat surface.

## Common Accessories

Accessory	S100	H100	H110	S300	S310	S400	S410
<b>Cable Safety Climb Kits</b> <i>no slider</i>	4.99.0485.150	4.99.0485.150	4.99.0485.150	4.99.0485.150	4.99.0485.150	4.99.0485.150	4.99.0485.150
<b>Step-Bolt Kit</b> <i>leg mounted</i>	4.98.0100.120	4.98.0100.120	4.98.0100.120	4.98.S300.120	4.98.S300.120	4.98.S400.120	4.98.S400.120

For more SuperTitan Accessories and Replacement Parts, see pages 61 to 76.

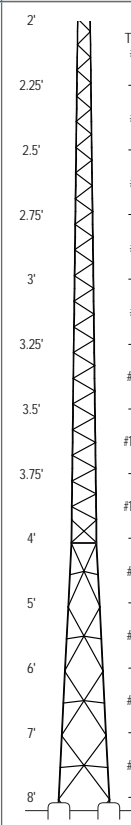
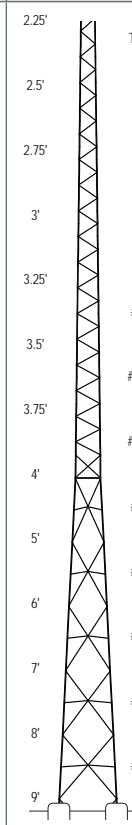
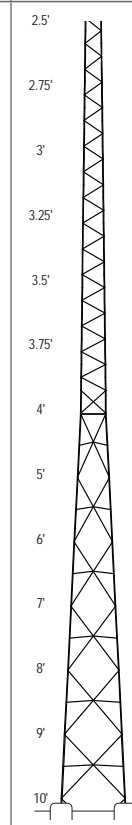
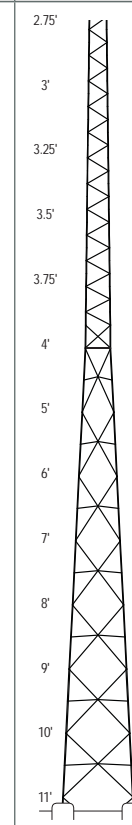
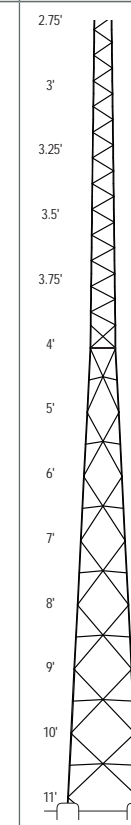
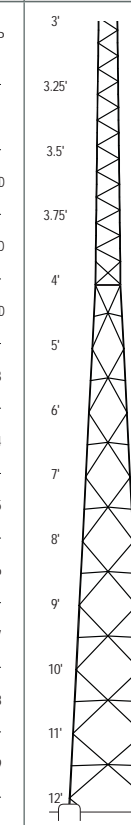
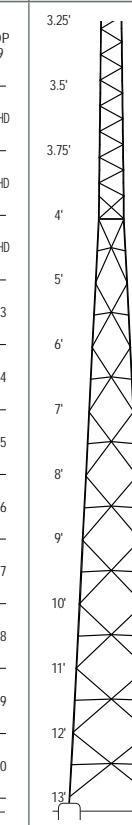
Model Designation:		S500	S600	S700	S800	S810	S910	S1010
Knocked-down Part Number:		5.94.0500.120	5.94.0600.120	5.94.0700.120	5.94.0800.120	5.94.0810.120	5.94.0910.120	5.94.1010.120
Assembled Part Number:		N/A	N/A	N/A	N/A	N/A	N/A	N/A
<p><i>Includes anchor material for concrete foundation, splice hardware, and pipe anchor brackets for antenna mounting pipe (pipe sold separately on page 68).</i></p> <p><i>Models S500 to S1010 use base feet and tie-rods for concrete foundation.</i></p>								
Allowable antenna area in ft <sup>2</sup> *	EIA 222-F 70/90/100 mph wind no ice	Round: 64/20/1 Flat: 42/14/1	Round: 95/30/10 Flat: 63/20/7	Round: 110/40/13 Flat: 73/26/8	Round: 122/52/31 Flat: 81/34/20	Round: 152/62/36 Flat: 101/41/24	Round: 170/88/55 Flat: 113/58/36	Round: 242/108/66 Flat: 161/72/44
	EIA Rev.G Class 1 90/105/120 mph wind 3/4" ice	Round: 48/16/-- Flat: 32/11/--	Round: 58/24/-- Flat: 39/16/--	Round: 80/36/10 Flat: 53/24/7	Round: 108/52/22 Flat: 72/35/15	Round: 108/52/22 Flat: 72/35/15	Round: 128/74/38 Flat: 85/49/25	Round: 180/106/52 Flat: 120/71/35
	EIA Rev.G Class 2 90/105/120 mph wind 3/4" ice	Round: 32/6/-- Flat: 21/4/--	Round: 44/12/-- Flat: 29/8/--	Round: 54/22/-- Flat: 36/15/--	Round: 78/36/10 Flat: 52/24/7	Round: 78/36/10 Flat: 52/24/7	Round: 108/52/24 Flat: 72/35/16	Round: 144/78/34 Flat: 96/52/23
Knocked-down Towers	L"xW"xH"	133x96x36	133x96x36	133x96x40	133x96x40	133x96x48	133x96x50	133x96x50
Assembled Towers	L"xW"xH"	N/A	N/A	N/A	N/A	N/A	N/A	N/A
Shipping Weight (lbs)		7,081	7,714	8,408	9,092	9,849	10,551	10,598

\*Assumptions: Projected areas (PA) shown are bare; a 1.5 multiplier used for iced area; loads centrally located and balanced at tower top; considers step-pegs, safety cable, and one 1/2" tx line per 10 sq.ft.; "--" indicates tower failure.  
 \*Round antennas include omnis, dipoles, dishes with radomes, etc. Antennas where wind hits a round surface. Flat Antennas include flat panels, dishes without radomes and cameras, where wind hits a flat surface.

## Common Accessories

Accessory	S500	S600	S700	S800	S810	S910	S1010
<b>Cable Safety Climb Kits</b> <i>no slider</i>	4.99.0485.150	4.99.0485.150	4.99.0485.150	4.99.0485.150	4.99.0485.150	4.99.0485.150	4.99.0485.150
<b>Step-Bolt Kit</b> <i>leg mounted</i>	4.98.S500.120	4.98.S600.120	4.98.S700.120	4.98.S800.120	4.98.S800.120	4.98.S900.120	4.98.1000.120

For more SuperTitan Accessories and Replacement Parts, see pages 61 to 76.

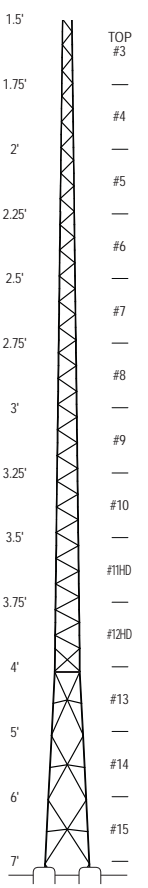
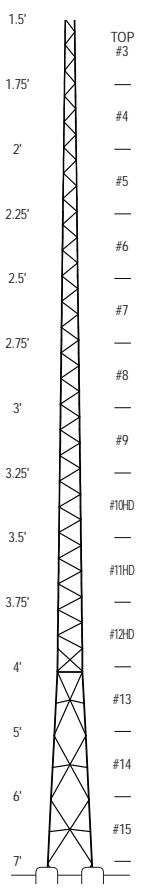
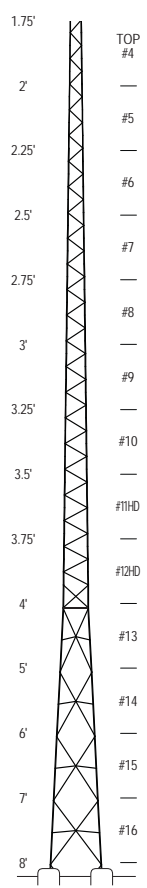
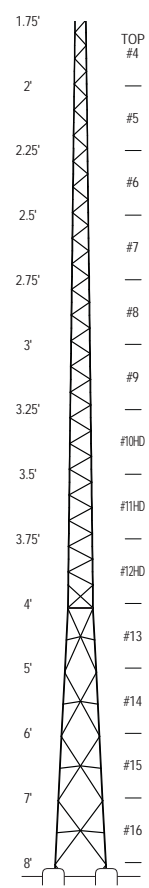
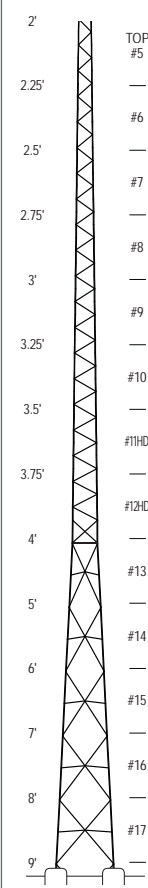
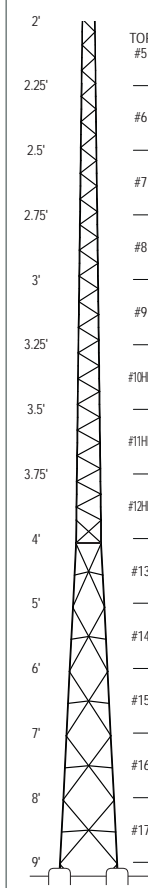
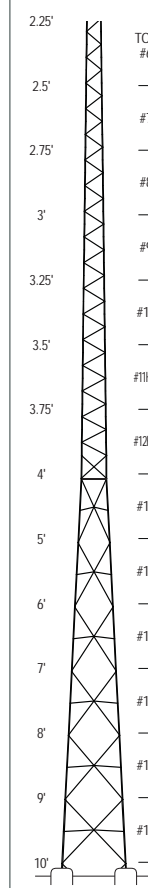
Model Designation:	S300	S310	S400	S410	S500	S510	S600	
Part Number:	5.94.0300.130	5.94.0310.130	5.94.0400.130	5.94.0410.130	5.94.0500.130	5.94.0510.130	5.94.0600.130	
Due to the weight, towers on this page are not available in pre-assembled 10' sections. They ship in "knock-down" format and require field assembly by experienced, professional, tower installers.  Trylon Distributors will stock individual 10', knock-down sections, therefore customers may choose to order towers by the section (see pages 56 and 57), rather than a complete tower kit. Ordering by section also facilitates choosing a different foundation/ anchorage system versus the anchor bolts and base feet supplied in kit format.  For example, to order the 130' S300, one can use the kit number 5.94.0300.130. Alternatively, one could order sections #3 Top, #4, #5, etc.  Models S300 to S600 include all 10' sections, base feet and tie-rods, splice hardware, and angle frame brackets to support a top antenna mounting pipe (pipe sold separately on page 68).								
Allowable antenna area in ft <sup>2</sup> *	EIA 222-F 70/90/100 mph wind no ice	Round: 24/--/-- Flat: 16/--/--	Round: 36/--/-- Flat: 24/--/--	Round: 41/6/-- Flat: 29/4/--	Round: 50/8/-- Flat: 33/5/--	Round: 60/18/-- Flat: 40/12/--	Round: 70/18/-- Flat: 47/12/--	Round: 88/27/8 Flat: 58/19/5
	EIA Rev.G Class 1 90/105/120 mph wind 3/4" ice	Round: --/--/-- Flat: --/--/--	Round: 14/--/-- Flat: 9/--/--	Round: 30/6/-- Flat: 20/4/--	Round: 30/6/-- Flat: 20/4/--	Round: 46/14/-- Flat: 31/9/--	Round: 46/14/-- Flat: 31/9/--	Round: 52/20/-- Flat: 35/13/--
	EIA Rev.G Class 2 90/105/120 mph wind 3/4" ice	Round: --/--/-- Flat: --/--/--	Round: 8/--/-- Flat: 5/--/--	Round: 20/--/-- Flat: 13/--/--	Round: 20/--/-- Flat: 13/--/--	Round: 30/--/-- Flat: 20/--/--	Round: 30/--/-- Flat: 20/--/--	Round: 40/8/-- Flat: 27/5/--
Shipping Dimensions (LxWxH")	133x96x40	133x96x40	133x96x40	133x96x40	133x96x40	133x96x40	133x96x40	
Shipping Weight (lbs)	6,719	6,766	7,293	7,340	7,929	7,976	8,687	

\*Assumptions: Projected areas (PA) shown are bare; a 1.5 multiplier used for iced area; loads centrally located and balanced at tower top; considers step-pegs, safety cable, and one 1/2" tx line per 10 sq.ft.; "--" indicates tower failure.  
\*Round antennas include omnis, dipoles, dishes with radomes, etc. Antennas where wind hits a round surface. Flat Antennas include flat panels, dishes without radomes and cameras, where wind hits a flat surface.

## Common Accessories

Accessory	S300	S310	S400	S410	S500	S510	S600
<b>Cable Safety Climb Kits</b> no slider	4.99.0485.150	4.99.0485.150	4.99.0485.150	4.99.0485.150	4.99.0485.150	4.99.0485.150	4.99.0485.150
<b>Step-Bolt Kit</b> leg mounted	4.98.S300.130	4.98.S300.130	4.98.S400.130	4.98.S400.130	4.98.S500.130	4.98.S500.130	4.98.S600.130

For more SuperTitan Accessories and Replacement Parts, see pages 61 to 76.

# 130' Towers continued



Model Designation:	S610	S700	S710	S800	S810	S900	S910	
Part Number:	5.94.0610.130	5.94.0700.130	5.94.0710.130	5.94.0800.130	5.94.0810.130	5.94.0900.130	5.94.0910.130	
<p><i>Due to the weight, towers on this page are not available in pre-assembled 10' sections. They ship in "knock-down" format and require field assembly by experienced, professional, tower installers.</i></p> <p><i>Trylon Distributors will stock individual 10', knock-down sections, therefore customers may choose to order towers by the section (see pages 56 and 57), rather than a complete tower kit. Ordering by section also facilitates choosing a different foundation/anchorage system versus the anchor bolts and base feet supplied in kit format.</i></p> <p><i>For example, to order the 130' S300, one can use the kit number 5.94.0300.130. Alternatively, one could order sections #3 Top, #4, #5, etc.</i></p> <p><i>Models S610 to S900 include all 10' sections, base feet and tie-rods, splice hardware, and angle frame brackets to support a top antenna mounting pipe (pipe sold separately on page 68).</i></p>								
Allowable antenna area in ft <sup>2</sup> *	EIA 222-F 70/90/100 mph wind no ice	Round: 92/28/6 Flat: 61/18/4	Round: 108/36/16 Flat: 72/24/10	Round: 124/41/18 Flat: 82/27/12	Round: 120/50/30 Flat: 80/33/20	Round: 150/60/32 Flat: 100/40/21	Round: 132/62/44 Flat: 88/41/29	Round: 166/80/43 Flat: 110/53/28
	EIA Rev.G Class 1 90/105/120 mph wind 3/4" ice	Round: 52/20/-- Flat: 35/13/--	Round: 76/32/8 Flat: 51/21/5	Round: 76/32/8 Flat: 51/21/5	Round: 102/48/20 Flat: 68/32/13	Round: 102/48/20 Flat: 68/32/13	Round: 126/70/36 Flat: 84/47/24	Round: 126/70/36 Flat: 84/47/24
	EIA Rev.G Class 2 90/105/120 mph wind 3/4" ice	Round: 40/8/-- Flat: 27/5/--	Round: 52/18/-- Flat: 35/12/--	Round: 52/18/-- Flat: 35/12/--	Round: 74/32/8 Flat: 49/21/5	Round: 74/32/8 Flat: 49/21/5	Round: 104/50/18 Flat: 69/33/12	Round: 104/50/18 Flat: 69/33/12
Shipping Dimensions (L"xW"xH")	133x96x40	133x96x40	133x96x40	133x96x48	133x96x48	133x96x48	133x96x48	
Shipping Weight (lbs)	8,734	9,397	9,444	10,164	10,211	10,870	10,917	

\*Assumptions: Projected areas (PA) shown are bare; a 1.5 multiplier used for iced area; loads centrally located and balanced at tower top; considers step-pegs, safety cable, and one 1/2" tx line per 10 sq.ft.; "--" indicates tower failure.  
\*Round antennas include omnis, dipoles, dishes with radomes, etc. Antennas where wind hits a round surface. Flat Antennas include flat panels, dishes without radomes and cameras, where wind hits a flat surface.

## Common Accessories

Accessory	S610	S700	S710	S800	S810	S900	S910
<b>Cable Safety Climb Kits</b> <i>no slider</i>	4.99.0485.150	4.99.0485.150	4.99.0485.150	4.99.0485.150	4.99.0485.150	4.99.0485.150	4.99.0485.150
<b>Step-Bolt Kit</b> <i>leg mounted</i>	4.98.S600.130	4.98.S700.130	4.98.S700.130	4.98.S800.130	4.98.S800.130	4.98.S900.130	4.98.S900.130

For more SuperTitan Accessories and Replacement Parts, see pages 61 to 76.

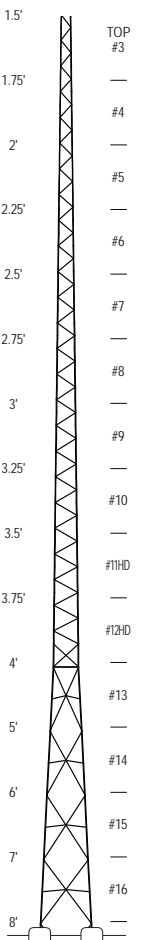
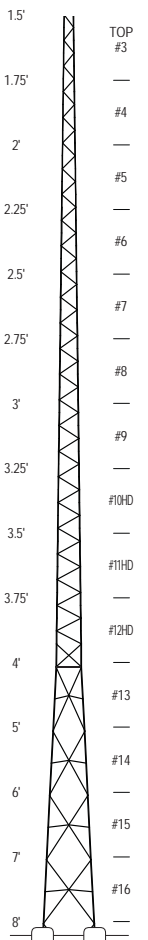
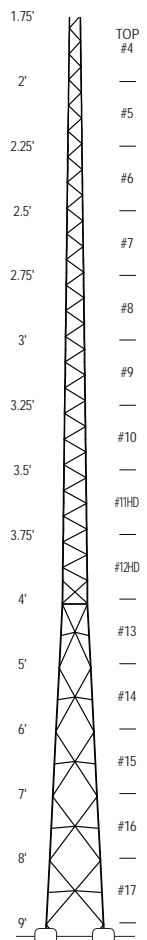
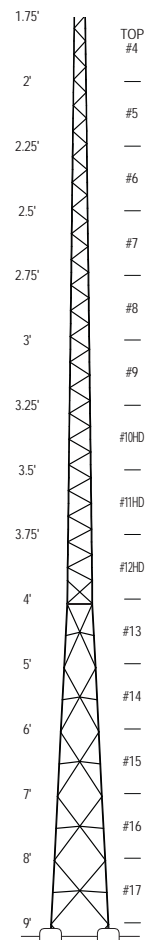
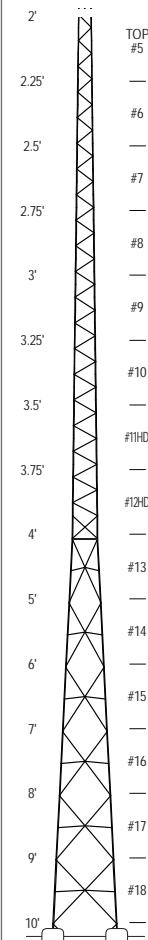
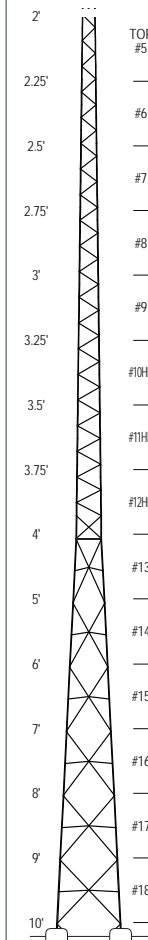
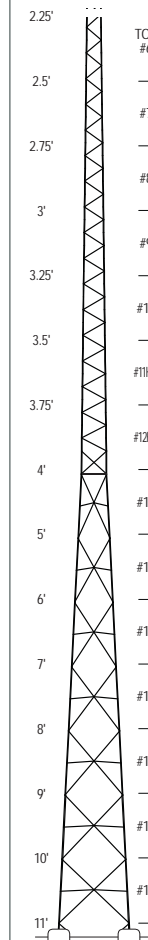

Model Designation:	S300	S310	S400	S410	S500	S510	S600	
Part Number:	5.94.0300.140	5.94.0310.140	5.94.0400.140	5.94.0410.140	5.94.0500.140	5.94.0510.140	5.94.0600.140	
<p>Due to the weight, towers on this page are not available in pre-assembled 10' sections. They ship in "knock-down" format and require field assembly by experienced, professional, tower installers.</p> <p>Trylon Distributors will stock individual 10', knock-down sections, therefore customers may choose to order towers by the section (see pages 56 and 57), rather than a complete tower kit. Ordering by section also facilitates choosing a different foundation/ anchorage system versus the anchor bolts and base feet supplied in kit format.</p> <p>For example, to order the 140' S300, one can use the kit number 5.94.0300.140. Alternatively, one could order sections #3 Top, #4, #5, etc.</p> <p>Models S300 to S600 include all 10' sections, base feet and tie-rods, splice hardware, and angle frame brackets to support a top antenna mounting pipe (pipe sold separately on page 68).</p>								
Allowable antenna area in ft <sup>2</sup> *	EIA 222-F 70/90/100 mph wind no ice	Round: 26/--/-- Flat: 18/--/--	Round: 34/--/-- Flat: 22/--/--	Round: 40/7/-- Flat: 28/5/--	Round: 48/6/-- Flat: 32/4/--	Round: 60/12/-- Flat: 40/8/--	Round: 66/14/-- Flat: 44/9/--	Round: 90/22/2 Flat: 60/14/1
	EIA Rev.G Class 1 90/105/120 mph wind 3/4" ice	Round: --/--/-- Flat: --/--/--	Round: 14/--/-- Flat: 9/--/--	Round: 30/--/-- Flat: 20/--/--	Round: 30/--/-- Flat: 20/--/--	Round: 42/10/-- Flat: 28/7/--	Round: 42/10/-- Flat: 28/7/--	Round: 52/18/-- Flat: 35/12/--
	EIA Rev.G Class 2 90/105/120 mph wind 3/4" ice	Round: --/--/-- Flat: --/--/--	Round: 6/--/-- Flat: 4/--/--	Round: 14/--/-- Flat: 9/--/--	Round: 14/--/-- Flat: 9/--/--	Round: 28/--/-- Flat: 19/--/--	Round: 28/--/-- Flat: 19/--/--	Round: 36/6/-- Flat: 24/4/--
Shipping Dimensions (LxWxH")	133x96x40	133x96x40	133x96x40	133x96x40	133x96x40	133x96x40	133x96x40	
Shipping Weight (lbs)	7,502	7,549	8,141	8,188	8,902	8,949	9,676	

\*Assumptions: Projected areas (PA) shown are bare; a 1.5 multiplier used for iced area; loads centrally located and balanced at tower top; considers step-pegs, safety cable, and one 1/2" tx line per 10 sq.ft.; "--" indicates tower failure.  
 \*\*Round antennas include omnis, dipoles, dishes with radomes, etc. Antennas where wind hits a round surface. Flat Antennas include flat panels, dishes without radomes and cameras, where wind hits a flat surface.

## Common Accessories

Accessory	S300	S310	S400	S410	S500	S510	S600
<b>Cable Safety Climb Kits</b> <i>no slider</i>	4.99.0485.150	4.99.0485.150	4.99.0485.150	4.99.0485.150	4.99.0485.150	4.99.0485.150	4.99.0485.150
<b>Step-Bolt Kit</b> <i>leg mounted</i>	4.98.S300.140	4.98.S300.140	4.98.S400.140	4.98.S400.140	4.98.S500.140	4.98.S500.140	4.98.S600.140

For more SuperTitan Accessories and Replacement Parts, see pages 61 to 76.

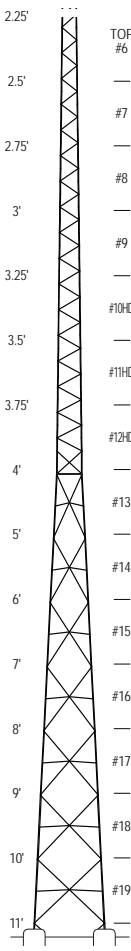
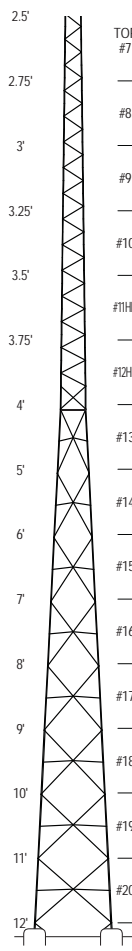
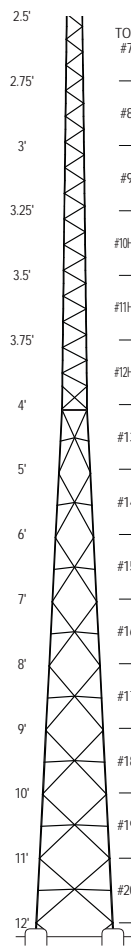
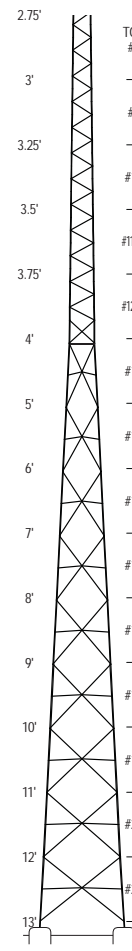
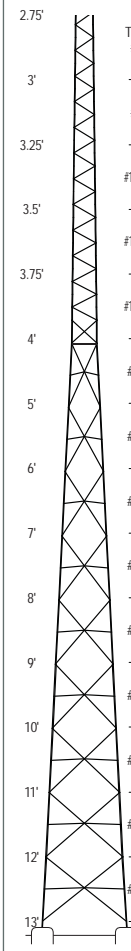

Model Designation:		S610	S700	S710	S800	S810		
Part Number:		5.94.0610.140	5.94.0700.140	5.94.0710.140	5.94.0800.140	5.94.0810.140		
<p><i>Due to the weight, towers on this page are not available in pre-assembled 10' sections. They ship in "knock-down" format and require field assembly by experienced, professional, tower installers.</i></p> <p><i>Trylon Distributors will stock individual 10', knock-down sections, therefore customers may choose to order towers by the section (see pages 56 and 57), rather than a complete tower kit. Ordering by section also facilitates choosing a different foundation/anchorage system versus the anchor bolts and base feet supplied in kit format.</i></p> <p><i>For example, to order the 140' S300, one can use the kit number 5.94.0300.140. Alternatively, one could order sections #3 Top, #4, #5, etc.</i></p> <p><i>Models S610 to S810 include all 10' sections, base feet and tie-rods, splice hardware, and angle frame brackets to support a top antenna mounting pipe (pipe sold separately on page 68).</i></p>								
Allowable antenna area in ft <sup>2</sup> *	EIA 222-F 70/90/100 mph wind no ice	Round: 90/24/3 Flat: 60/16/2	Round: 100/36/14 Flat: 67/24/10	Round: 120/40/15 Flat: 80/27/10	Round: 116/44/24 Flat: 78/30/16	Round: 144/56/25 Flat: 96/38/17		
	EIA Rev.G Class 1 90/105/120 mph wind 3/4" ice	Round: 52/18/-- Flat: 35/12/--	Round: 72/30/6 Flat: 48/20/4	Round: 72/30/6 Flat: 48/20/4	Round: 98/46/18 Flat: 65/31/12	Round: 98/46/18 Flat: 65/31/12		
	EIA Rev.G Class 2 90/105/120 mph wind 3/4" ice	Round: 36/6/-- Flat: 24/4/--	Round: 50/16/-- Flat: 33/11/--	Round: 50/16/-- Flat: 33/11/--	Round: 70/30/4 Flat: 47/20/3	Round: 70/30/4 Flat: 47/20/3		
Shipping Dimensions (L"xW"xH")		133x96x40	133x96x48	133x96x48	133x96x48	133x96x48		
Shipping Weight (lbs)		9,723	10,469	10,516	11,185	11,232		

\*Assumptions: Projected areas (PA) shown are bare; a 1.5 multiplier used for iced area; loads centrally located and balanced at tower top; considers step-pegs, safety cable, and one 1/2" tx line per 10 sq.ft.; "--" indicates tower failure.  
 \*Round antennas include omnis, dipoles, dishes with radomes, etc. Antennas where wind hits a round surface. Flat Antennas include flat panels, dishes without radomes and cameras, where wind hits a flat surface.

## Common Accessories

Accessory	S610	S700	S710	S800	S810		
<b>Cable Safety Climb Kits</b> <i>no slider</i>	4.99.0485.150	4.99.0485.150	4.99.0485.150	4.99.0485.150	4.99.0485.150		
<b>Step-Bolt Kit</b> <i>leg mounted</i>	4.98.S600.140	4.98.S700.140	4.98.S700.140	4.98.S800.140	4.98.S800.140		

For more SuperTitan Accessories and Replacement Parts, see pages 61 to 76.

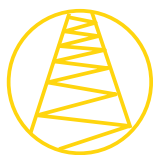

Model Designation:		S300	S310	S400	S410	S500	S510	S600
Part Number:		5.94.0300.150	5.94.0310.150	5.94.0400.150	5.94.0410.150	5.94.0500.150	5.94.0510.150	5.94.0600.150
<p>Due to the weight, towers on this page are not available in pre-assembled 10' sections. They ship in "knock-down" format and require field assembly by experienced, professional, tower installers.</p> <p>Trylon Distributors will stock individual 10', knock-down sections, therefore customers may choose to order towers by the section (see pages 56 and 57), rather than a complete tower kit. Ordering by section also facilitates choosing a different foundation/ anchorage system versus the anchor bolts and base feet supplied in kit format.</p> <p>For example, to order the 150' S300, one can use the kit number 5.94.0300.150. Alternatively, one could order sections #3 Top, #4, #5, etc.</p> <p>Models S300 to S600 include all 10' sections, base feet and tie-rods, splice hardware, and angle frame brackets to support a top antenna mounting pipe (pipe sold separately on page 68).</p>								
Allowable antenna area in ft <sup>2</sup> *	EIA 222-F 70/90/100 mph wind no ice	Round: 24/--/-- Flat: 17/--/--	Round: 31/--/-- Flat: 21/--/--	Round: 46/7/-- Flat: 31/5/--	Round: 46/7/-- Flat: 31/5/--	Round: 56/13/-- Flat: 38/9/--	Round: 60/13/-- Flat: 40/9/--	Round: 88/23/1 Flat: 59/16/--
	EIA Rev.G Class 1 90/105/120 mph wind 3/4" ice	Round: --/--/-- Flat: --/--/--	Round: 14/--/-- Flat: 9/--/--	Round: 30/--/-- Flat: 20/--/--	Round: 30/--/-- Flat: 20/--/--	Round: 40/8/-- Flat: 27/5/--	Round: 40/8/-- Flat: 27/5/--	Round: 50/14/-- Flat: 33/9/--
	EIA Rev.G Class 2 90/105/120 mph wind 3/4" ice	Round: --/--/-- Flat: --/--/--	Round: 6/--/-- Flat: 4/--/--	Round: 14/--/-- Flat: 9/--/--	Round: 14/--/-- Flat: 9/--/--	Round: 24/--/-- Flat: 16/--/--	Round: 24/--/-- Flat: 16/--/--	Round: 34/4/-- Flat: 23/3/--
Shipping Dimensions (L"xW"xH")		133x96x40	133x96x40	133x96x40	133x96x40	133x96x40	133x96x40	133x96x48
Shipping Weight (lbs)		8,350	8,397	9,114	9,161	9,891	9,938	10,748

\*Assumptions: Projected areas (PA) shown are bare; a 1.5 multiplier used for iced area; loads centrally located and balanced at tower top; considers step-pegs, safety cable, and one 1/2" tx line per 10 sq.ft.; "--" indicates tower failure.  
\*Round antennas include omnis, dipoles, dishes with radomes, etc. Antennas where wind hits a round surface. Flat Antennas include flat panels, dishes without radomes and cameras, where wind hits a flat surface.

## Common Accessories

Accessory	S300	S310	S400	S410	S500	S510	S600
<b>Step-Bolt Kit</b> leg mounted	4.98.S300.150	4.98.S300.150	4.98.S400.150	4.98.S400.150	4.98.S500.150	4.98.S500.150	4.98.S600.150

For more SuperTitan Accessories and Replacement Parts, see pages 61 to 76.

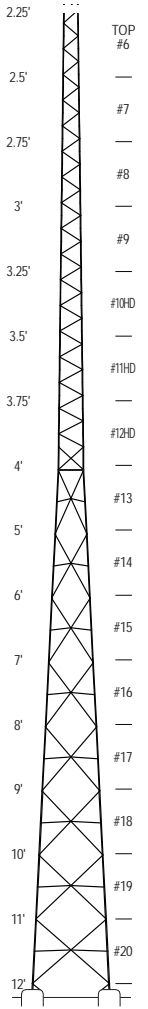
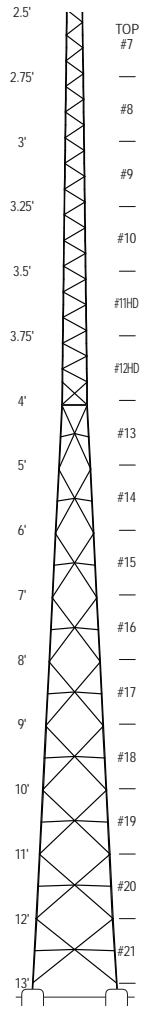
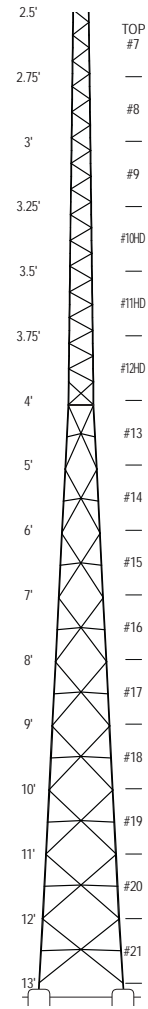
Model Designation:		S610	S700	S710			
Part Number:		5.94.0610.150	5.94.0700.150	5.94.0710.150			
<p>Due to the weight, towers on this page are not available in pre-assembled 10' sections. They ship in "knock-down" format and require field assembly by experienced, professional, tower installers.</p> <p>Trylon Distributors will stock individual 10', knock-down sections, therefore customers may choose to order towers by the section (see pages 56 and 57), rather than a complete tower kit. Ordering by section also facilitates choosing a different foundation/ anchorage system versus the anchor bolts and base feet supplied in kit format.</p> <p>For example, to order the 150' S300, one can use the kit number 5.94.0300.150. Alternatively, one could order sections #3 Top, #4, #5, etc.</p> <p>Models S610 to S710 include all 10' sections, base feet and tie-rods, splice hardware, and angle frame brackets to support a top antenna mounting pipe (pipe sold separately on page 68).</p>							
Allowable antenna area in ft <sup>2</sup> *	EIA 222-F 70/90/100 mph wind no ice	Round: 88/23/1 Flat: 59/16/1	Round: 100/34/10 Flat: 67/23/7	Round: 118/37/10 Flat: 79/25/7			
	EIA Rev.G Class 1 90/105/120 mph wind 3/4" ice	Round: 50/14/-- Flat: 33/9/--	Round: 68/30/4 Flat: 45/20/3	Round: 68/30/4 Flat: 45/20/3			
	EIA Rev.G Class 2 90/105/120 mph wind 3/4" ice	Round: 34/4/-- Flat: 23/3/--	Round: 48/14/-- Flat: 32/9/--	Round: 48/14/-- Flat: 32/9/--			
Shipping Dimensions (L"xW"xH")		133x96x48	133x96x48	133x96x48			
Shipping Weight (lbs)		10,795	11,490	11,537			



\*Assumptions: Projected areas (PA) shown are bare; a 1.5 multiplier used for iced area; loads centrally located and balanced at tower top; considers step-pegs, safety cable, and one 1/2" x 11mm per 10 sq.ft.; -- Indicates tower failure.  
\*Round antennas include omnis, dipoles, dishes with radomes, etc. Antennas where wind hits a round surface. Flat Antennas include flat panels, dishes without radomes and cameras, where wind hits a flat surface.

## Common Accessories

Accessory	S610	S700	S710			
<b>Step-Bolt Kit</b> <i>leg mounted</i>	4.98.S600.150	4.98.S700.150	4.98.S700.150			

For more SuperTitan Accessories and Replacement Parts, see pages 61 to 76.

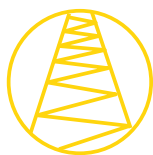

Model Designation:		S300	S310	S400	S500	S510	S600	S610
Part Number:		5.94.0300.160	5.94.0310.160	5.94.0400.160	5.94.0500.160	5.94.0510.160	5.94.0600.160	5.94.0610.160
<p>Due to the weight, towers on this page are not available in pre-assembled 10' sections. They ship in "knock-down" format and require field assembly by experienced, professional, tower installers.</p> <p>Trylon Distributors will stock individual 10', knock-down sections, therefore customers may choose to order towers by the section (see pages 56 and 57), rather than a complete tower kit. Ordering by section also facilitates choosing a different foundation/ anchorage system versus the anchor bolts and base feet supplied in kit format.</p> <p>For example, to order the 160' S300, one can use the kit number 5.94.0300.160. Alternatively, one could order sections #3 Top, #4, #5, etc.</p> <p>Models S300 to S610 include all 10' sections, base feet and tie-rods, splice hardware, and angle frame brackets to support a top antenna mounting pipe (pipe sold separately on page 68).</p>								
Allowable antenna area in ft <sup>2</sup> *	EIA 222-F 70/90/100 mph wind no ice	Round: 23/--/-- Flat: 16/--/--	Round: 30/--/-- Flat: 20/--/--	Round: 38/1/-- Flat: 26/--/--	Round: 58/10/-- Flat: 39/7/--	Round: 61/10/-- Flat: 41/7/--	Round: 82/20/-- Flat: 55/13/--	Round: 86/20/-- Flat: 58/13/--
	EIA Rev.G Class 1 90/105/120 mph wind 3/4" ice	Round: --/--/-- Flat: --/--/--	Round: 14/--/-- Flat: 9/--/--	Round: 28/--/-- Flat: 19/--/--	Round: 36/6/-- Flat: 24/4/--	Round: 36/6/-- Flat: 24/4/--	Round: 48/14/-- Flat: 32/9/--	Round: 48/14/-- Flat: 32/9/--
	EIA Rev.G Class 2 90/105/120 mph wind 3/4" ice	Round: --/--/-- Flat: --/--/--	Round: 4/--/-- Flat: 3/--/--	Round: 14/--/-- Flat: 9/--/--	Round: 22/--/-- Flat: 15/--/--	Round: 22/--/-- Flat: 15/--/--	Round: 30/2/-- Flat: 20/1/--	Round: 30/2/-- Flat: 20/1/--
Shipping Dimensions (L"xW"xH")		133x96x40	133x96x40	133x96x48	133x96x48	133x96x48	133x96x48	133x96x48
Shipping Weight (lbs)		9,323	9,370	10,178	10,963	11,010	11,769	11,816

\*Assumptions: Projected areas (PA) shown are bare; a 1.5 multiplier used for iced area; loads centrally located and balanced at tower top; considers step-pegs, safety cable, and one 1/2" tx line per 10 sq.ft.; "--" indicates tower failure.  
\*Round antennas include omnis, dipoles, dishes with radomes, etc. Antennas where wind hits a round surface. Flat Antennas include flat panels, dishes without radomes and cameras, where wind hits a flat surface.

For more SuperTitan Accessories and Replacement Parts, see pages 61 to 76.

# 170' Towers



Model Designation:		S300	S310	S400	S410	S500	S510
Part Number:		5.94.0300.170	5.94.0310.170	5.94.0400.170	5.94.0410.170	5.94.0500.170	5.94.0510.170
<p>Due to the weight, towers on this page are not available in pre-assembled 10' sections. They ship in "knock-down" format and require field assembly by experienced, professional, tower installers.</p> <p>Trylon Distributors will stock individual 10', knock-down sections, therefore customers may choose to order towers by the section (see pages 56 and 57), rather than a complete tower kit. Ordering by section also facilitates choosing a different foundation/anchorage system versus the anchor bolts and base feet supplied in kit format.</p> <p>For example, to order the 170' S300, one can use the kit number 5.94.0300.170. Alternatively, one could order sections #3 Top, #4, #5, etc.</p> <p>Models S300 to S510 include all 10' sections, base feet and tie-rods, splice hardware, and angle frame brackets to support a top antenna mounting pipe (pipe sold separately on page 68).</p>							
Allowable antenna area in ft <sup>2</sup> *	EIA 222-F 70/90/100 mph wind no ice	Round: 21/-- Flat: 15/--	Round: 30/-- Flat: 20/--	Round: 36/-- Flat: 25/--	Round: 42/-- Flat: 28/--	Round: 57/10/ Flat: 40/7--	Round: 60/10/ Flat: 40/6--
	EIA Rev.G Class 1 90/105/120 mph wind 3/4" ice	Round: --/-- Flat: --/--	Round: 12/-- Flat: 8/--	Round: 24/-- Flat: 16/--	Round: 24/-- Flat: 16/--	Round: 34/4/ Flat: 23/3--	Round: 34/4/ Flat: 23/3--
	EIA Rev.G Class 2 90/105/120 mph wind 3/4" ice	Round: --/-- Flat: --/--	Round: 2/-- Flat: 1/--	Round: 12/-- Flat: 8/--	Round: 12/-- Flat: 8/--	Round: 18/-- Flat: 12/--	Round: 18/-- Flat: 12/--
Shipping Dimensions (L"xW"xH")		133x96x53	133x96x53	133x96x54	133x96x54	133x96x54	133x96x54
Shipping Weight (lbs)		10,387	10,434	11,175	11,222	11,984	12,031

\*Assumptions: Projected areas (PA) shown are bare; a 1.5 multiplier used for iced area; loads centrally located and balanced at tower top; considers step-pegs, safety cable, and one 1/2" tx line per 10 sq.ft.; "--" indicates tower failure.  
\*Round antennas include omnis, dipoles, dishes with radomes, etc. Antennas where wind hits a round surface. Flat Antennas include flat panels, dishes without radomes and cameras, where wind hits a flat surface.

For more SuperTitan Accessories and Replacement Parts, see pages 61 to 76.





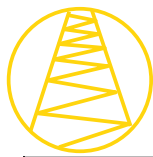

Model Designation:		S300	S310	S400	S410			
Part Number:		5.94.0300.180	5.94.0310.180	5.94.0400.180	5.94.0410.180			
<p>Due to the weight, towers on this page are not available in pre-assembled 10' sections. They ship in "knock-down" format and require field assembly by experienced, professional, tower installers.</p> <p>Trylon Distributors will stock individual 10', knock-down sections, therefore customers may choose to order towers by the section (see pages 56 and 57), rather than a complete tower kit. Ordering by section also facilitates choosing a different foundation/ anchorage system versus the anchor bolts and base feet supplied in kit format.</p> <p>For example, to order the 180' S300, one can use the kit number 5.94.0300.180. Alternatively, one could order sections #3 Top, #4, #5, etc.</p> <p>Models S300 and S410 include all 10' sections, base feet and tie-rods, splice hardware, and angle frame brackets to support a top antenna mounting pipe (pipe sold separately on page 68).</p>						<p>Cable Safety Climb Kit – pg 67 (slider not included)</p>		
Allowable antenna area in ft <sup>2</sup> *	EIA 222-F 70/90/100 mph wind no ice	Round: 20/--/-- Flat: 14/--/--	Round: 28/--/-- Flat: 19/--/--	Round: 35/--/-- Flat: 25/--/--	Round: 40/--/-- Flat: 27/--/--			
	EIA Rev.G Class 1 90/105/120 mph wind 3/4" ice	Round: --/--/-- Flat: --/--/--	Round: 12/--/-- Flat: 8/--/--	Round: 22/--/-- Flat: 15/--/--	Round: 22/--/-- Flat: 15/--/--			
	EIA Rev.G Class 2 90/105/120 mph wind 3/4" ice	Round: --/--/-- Flat: --/--/--	Round: --/--/-- Flat: --/--/--	Round: 10/--/-- Flat: 7/--/--	Round: 10/--/-- Flat: 7/--/--			
Shipping Dimensions (LxWxH")		133x96x54	133x96x54	133x96x55	133x96x55			
Shipping Weight (lbs)		11,384	11,431	12,196	12,243			



\*Assumptions: Projected areas (PA) shown are bare; a 1.5 multiplier used for iced area; loads centrally located and balanced at tower top; considers step-pegs, safety cable, and one 1/2" tx line per 10 sq.ft.; "--" indicates tower failure.  
 \*\*Round antennas include omnis, dipoles, dishes with radomes, etc. Antennas where wind hits a round surface. Flat Antennas include flat panels, dishes without radomes and cameras, where wind hits a flat surface.

For more SuperTitan Accessories and Replacement Parts, see pages 61 to 76.



# 190' Towers



Model Designation:		S300	S310
Part Number:		5.94.0300.190	5.94.0310.190
<p>Due to the weight, towers on this page are not available in pre-assembled 10' sections. They ship in "knock-down" format and require field assembly by experienced, professional, tower installers.</p> <p>Trylon Distributors will stock individual 10' knock-down sections, therefore customers may choose to order towers by the section (see pages 56 and 57), rather than a complete tower kit. Ordering by section also facilitates choosing a different foundation/ anchorage system versus the anchor bolts and base feet supplied in kit format.</p> <p>For example, to order the 190' S300, one can use the kit number 5.94.0300.190. Alternatively, one could order sections #3 Top, #4, #5, etc.</p> <p>Models S300 and S310 include all 10' sections, base feet and tie-rods, splice hardware, and angle frame brackets to support a top antenna mounting pipe (pipe sold separately on page 68).</p>			
Allowable antenna area in ft <sup>2</sup> *	EIA 222-F 70/90/100 mph wind no ice	Round: 20/-- Flat: 14/--	Round: 26/-- Flat: 18/--
	EIA Rev.G Class 1 90/105/120 mph wind 3/4" ice	Round: --/-- Flat: --/--	Round: 10/-- Flat: 7/--
	EIA Rev.G Class 2 90/105/120 mph wind 3/4" ice	Round: --/-- Flat: --/--	Round: --/-- Flat: --/--
Shipping Dimensions (L"xW"xH")		133x96x55	133x96x55
Shipping Weight (lbs)		12,405	12,452

Cable Safety Climb Kit – pg 67  
(slider not included)

Step-Peg Ladder – pg 59

\*Assumptions: Projected areas (PA) shown are bare; a 1.5 multiplier used for iced area; loads centrally located and balanced at tower top; considers step-pegs, safety cable, and one 1/2" tx line per 10 sq.ft.; "--" indicates tower failure.  
 \*\*Round antennas include omnis, dipoles, dishes with radomes, etc. Antennas where wind hits a round surface. Flat Antennas include flat panels, dishes without radomes and cameras, where wind hits a flat surface.

For more SuperTitan Accessories and Replacement Parts, see pages 61 to 76.

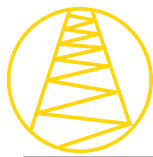

# SUPER TITAN™ KD Individual Tower Sections

## Knocked-Down Regular Sections # 2 - #21

Part Number	Description	Ship Wt. (lbs)	Ship LxWxH (in)	Image
5.94.0021.000	Knocked-down SuperTitan Regular section # 2	192	122x12x14	 <p>Section #14 5.94.0141.000</p>
5.94.0031.000	Knocked-down SuperTitan Regular section # 3	192	122x12x14	
5.94.0041.000	Knocked-down SuperTitan Regular section # 4	198	122x12x14	
5.94.0051.000	Knocked-down SuperTitan Regular section # 5	201	122x12x14	
5.94.0061.000	Knocked-down SuperTitan Regular section # 6	263	122x12x14	
5.94.0071.000	Knocked-down SuperTitan Regular section # 7	298	122x12x14	
5.94.0081.000	Knocked-down SuperTitan Regular section # 8	302	122x12x14	
5.94.0091.000	Knocked-down SuperTitan Regular section # 9	305	122x12x14	
5.94.0101.000	Knocked-down SuperTitan Regular section #10	338	122x12x14	
5.94.0111.000	Knocked-down SuperTitan Regular section #11	344	122x12x14	
5.94.0121.000	Knocked-down SuperTitan Regular section #12	349	122x12x14	
5.94.0101.0HD	Knocked-down SuperTitan Heavy Duty section #10HD (5/16" thk legs)	417	122x12x14	
5.94.0111.0HD	Knocked-down SuperTitan Heavy Duty section #11HD (5/16" thk legs)	523	122x12x14	
5.94.0121.0HD	Knocked-down SuperTitan Heavy Duty section #12HD (5/16" thk legs)	530	122x12x14	
5.94.0131.000	Knocked-down SuperTitan Regular section #13	920	122x12x14	
5.94.0141.000	Knocked-down SuperTitan Regular section #14	758	122x12x14	
5.94.0151.000	Knocked-down SuperTitan Regular section #15	774	122x12x14	
5.94.0161.000	Knocked-down SuperTitan Regular section #16	792	122x12x14	
5.94.0171.000	Knocked-down SuperTitan Regular section #17	857	122x12x14	
5.94.0181.000	Knocked-down SuperTitan Regular section #18	960	122x12x14	
5.94.0191.000	Knocked-down SuperTitan Regular section #19	983	122x12x14	
5.94.0201.000	Knocked-down SuperTitan Regular section #20	1006	122x12x14	
5.94.0211.000	Knocked-down SuperTitan Regular section #21	1030	122x12x14	

## Knocked-Down Top Sections # 1 - #12HD (pipe not included)

Part Number	Description	Ship Wt. (lbs)	Ship LxWxH (in)	Image
5.94.0012.000	Knocked-down SuperTitan Top section # 1	224	122x40x14	
5.94.0022.000	Knocked-down SuperTitan Top section # 2	234	122x40x14	
5.94.0032.000	Knocked-down SuperTitan Top section # 3	244	122x40x14	
5.94.0042.000	Knocked-down SuperTitan Top section # 4	254	122x40x14	
5.94.0052.000	Knocked-down SuperTitan Top section # 5	264	122x40x14	
5.94.0062.000	Knocked-down SuperTitan Top section # 6	333	122x40x14	
5.94.0072.000	Knocked-down SuperTitan Top section # 7	373	122x40x14	
5.94.0082.000	Knocked-down SuperTitan Top section # 8	403	122x40x14	
5.94.0092.000	Knocked-down SuperTitan Top section # 9	408	122x40x14	
5.94.0102.000	Knocked-down SuperTitan Top section #10	437	122x40x14	
5.94.0102.0HD	Knocked-down SuperTitan Top section #10HD section (5/16" thk legs)	519	122x40x14	
5.94.0112.0HD	Knocked-down SuperTitan Top section #11 HD section (5/16" thk legs)	554	122x40x14	
5.94.0122.0HD	Knocked-down SuperTitan Top section #12 HD section (5/16" thk legs)	558	122x40x14	

# Individual Tower sections



**SUPER  
TITAN™** **KD**

<b>Assembled Regular Sections # 2 - #12HD</b>				
<b>Part Number</b>	<b>Description</b>	<b>Ship Wt. (lbs)</b>	<b>Ship LxWxH (in)</b>	<b>Image</b>
5.95.0021.000	Assembled # 2 SuperTitan Regular section	216	133x40x24	
5.95.0031.000	Assembled # 3 SuperTitan Regular section	219	133x40x27	
5.95.0041.000	Assembled # 4 SuperTitan Regular section	223	133x40x30	
5.95.0051.000	Assembled # 5 SuperTitan Regular section	229	133x40x33	
5.95.0061.000	Assembled # 6 SuperTitan Regular section	285	133x40x37	
5.95.0071.000	Assembled # 7 SuperTitan Regular section	321	133x40x40	
5.95.0081.000	Assembled # 8 SuperTitan Regular section	325	133x40x43	
5.95.0091.000	Assembled # 9 SuperTitan Regular section	328	133x40x47	
5.95.0101.000	Assembled #10 SuperTitan Regular section	337	133x40x50	
5.95.0101.0HD	Assembled #10 SuperTitan Heavy Duty section (5/16" thk legs)	417	133x40x48	
5.95.0111.000	Assembled #11 SuperTitan Regular section	368	133x48x53	
5.95.0111.0HD	Assembled #11 SuperTitan Heavy Duty section (5/16" thk legs)	469	133x48x53	
5.95.0121.000	Assembled #12 SuperTitan Regular section	372	133x48x53	
5.95.0121.0HD	Assembled #12 SuperTitan Heavy Duty section (5/16" thk legs)	473	133x48x53	

<b>Assembled Top Sections #1 - #10 (pipe not included)</b>				
<b>Part Number</b>	<b>Description</b>	<b>Ship Wt. (lbs)</b>	<b>Ship LxWxH (in)</b>	<b>Image</b>
5.95.0012.000	Assembled SuperTitan Top section # 1	250	133x40x18	
5.95.0022.000	Assembled SuperTitan Top section # 2	252	133x40x21	
5.95.0032.000	Assembled SuperTitan Top section # 3	261	133x40x27	
5.95.0042.000	Assembled SuperTitan Top section # 4	270	133x40x30	
5.95.0052.000	Assembled SuperTitan Top section # 5	277	133x40x33	
5.95.0062.000	Assembled SuperTitan Top section # 6	342	133x40x37	
5.95.0072.000	Assembled SuperTitan Top section # 7	388	133x40x40	
5.95.0082.000	Assembled SuperTitan Top section # 8	423	133x48x40	
5.95.0092.000	Assembled SuperTitan Top section # 9	428	133x48x40	
5.95.0102.000	Assembled SuperTitan Top section #10	435	133x48x40	

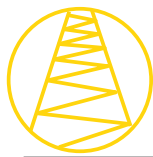

# SUPER TITAN™ KD Individual Tower Sections

## Anchor Kits for Concrete Foundations

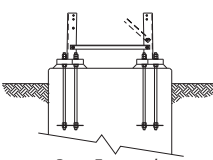
Part Number	Description	Ship Wt. (lbs)	Ship LxWxH (in)	Image
5.81.0202.000	5' Foundation section 2F - fits section # 1	111	60x40x8	 <p>5' Foundation section</p>  <p>Base Feet and Tie-rod Kit</p>
5.81.0203.000	5' Foundation section 3F - fits section # 2	114	60x40x8	
5.81.0204.000	5' Foundation section 4F - fits section # 3	117	60x40x8	
5.81.0205.000	5' Foundation section 5F - fits section # 4	120	60x40x8	
5.81.0206.000	5' Foundation section 6F - fits section # 5	150	60x40x8	
5.81.0207.000	5' Foundation section 7F - fits section # 6	167	60x40x8	
5.81.0208.000	5' Foundation section 8F - fits section # 7	169	60x40x8	
5.81.0209.000	5' Foundation section 9F - fits section # 8	178	60x48x8	
5.81.0210.000	5' Foundation section 10F - fits section # 9	182	60x48x8	
5.81.0211.000	5' Foundation section 11F - fits section #10	235	60x48x8	
5.81.0212.000	5' Foundation section 12F - fits section #11	301	60x48x8	
5.81.0213.000	5' Foundation section 13F - fits section #12	311	60x51x8	
5.81.0213.0HD	5' Foundation section 13HDF - fits section #12HD	325	60x40x8	
4.79.0000.015	Base Feet and Tie-rod Kit - fits section #14	715	84x22x26	
4.79.0000.016	Base Feet and Tie-rod Kit - fits section #15	722	84x22x26	
4.79.0000.017	Base Feet and Tie-rod Kit - fits section #16	730	95x22x26	
4.79.0000.018	Base Feet and Tie-rod Kit - fits section #17	737	107x22x26	
4.79.0000.019	Base Feet and Tie-rod Kit - fits section #18	766	120x22x26	
4.79.0000.020	Base Feet and Tie-rod Kit - fits section #19	787	84x22x26	
4.79.0000.021	Base Feet and Tie-rod Kit - fits section #20	794	84x22x26	
4.79.0000.022	Base Feet and Tie-rod Kit - fits section #21	802	84x22x26	

## P.E. Stamped Drawings

### P.E. Stamped Drawings (for all States except Alaska and Hawaii – contact Tylon for pricing on Alaskan and Hawaiian stamps)

Part Number	Description	Ship Wt. (lbs)	Image
4.77.0101.100*	P.E. Stamped Dwg: Tower profile & standard FDN	2	
4.77.0101.300**	P.E. Stamped Dwg: Special soil FDN analysis & design	2	
4.77.0101.302***	P.E. Stamped Dwg: Tower profile & special soil FDN design	2	

\* To order this P.E. stamped drawing, a completed "tower loading questionnaire" must accompany your PO to Tylon's distributor. Questions include: maximum design wind speed, radial ice accumulation, projected antenna area in sq. ft., etc. To download questionnaire, go to [www.tylon.com](http://www.tylon.com) and follow links: USA - Light Duty Towers - SuperTitan - Sizing/TowerCalc - Option 2.

\*\* This requires an official geotechnical soils report to be submitted along with the purchase order for this special foundation design/analysis. PO will not be accepted without geotechnical soils report for the site in question.

\*\*\* To order this package, you must submit a site-specific geotechnical soils report along with your tower loading questionnaire and PO.

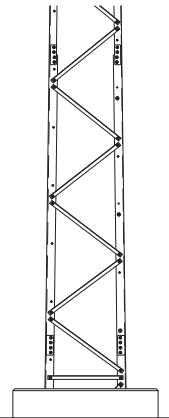

Step-Bolt Climbing Kits			
Part Number	Description	Ship Wt. (lbs)	Image
4.98.0100.010	Step-Bolt Kit for 10' SuperTitan section (leg mounted & screw-in)	12	
4.98.0100.020	Step-Bolt Kit for 20' SuperTitan Tower (leg mounted & screw-in)	24	
4.98.0100.030	Step-Bolt Kit for 30' SuperTitan Tower (leg mounted & screw-in)	36	
4.98.0100.040	Step-Bolt Kit for 40' SuperTitan Tower (leg mounted & screw-in)	48	
4.98.0100.050	Step-Bolt Kit for 50' SuperTitan Tower (leg mounted & screw-in)	60	
4.98.0100.060	Step-Bolt Kit for 60' SuperTitan Tower (leg mounted & screw-in)	72	
4.98.0100.070	Step-Bolt Kit for 70' SuperTitan Tower (leg mounted & screw-in)	84	
4.98.0100.080	Step-Bolt Kit for 80' SuperTitan Tower (leg mounted & screw-in)	96	
4.98.0100.090	Step-Bolt Kit for 90' SuperTitan Tower (leg mounted & screw-in)	108	
4.98.0100.100	Step-Bolt Kit for 100' SuperTitan Tower (leg mounted & screw-in)	120	
4.98.0100.110	Step-Bolt Kit for 110' SuperTitan Tower (leg mounted & screw-in)	132	
4.98.0100.120	Step-Bolt Kit for 120' SuperTitan Tower (leg mounted & screw-in)	144	
4.98.0200.010	Welded Step-Peg Ladder, 10' long (STSS sect #13 - #21 only)	40	
4.98.0200.020	Welded, Base (bot) Step-Peg Ladder, 23-1/6" long (STSS sect #13 - #21)	10	
4.98.1000.050	Step-Bolt Kit for 50' S1000 (2 welded sect & 3 screw-in)	236	
4.98.1100.050	Step-Bolt Kit for 50' S1100 (3 welded sect & 2 screw-in)	274	
4.98.1200.050	Step-Bolt Kit for 50' S1200 (4 welded sect & 1 screw-in)	312	
4.98.S900.060	Step-Bolt Kit for 60' S900 (2 welded sect & 4 screw-in)	248	
4.98.1000.060	Step-Bolt Kit for 60' S1000 (3 welded sect & 3 screw-in)	286	
4.98.1100.060	Step-Bolt Kit for 60' S1100 (4 welded sect & 2 screw-in)	336	
4.98.S800.070	Step-Bolt Kit for 70' S800 (2 welded sect & 5 screw-in)	260	
4.98.S900.070	Step-Bolt Kit for 70' S900 (3 welded sect & 4 screw-in)	298	
4.98.1000.070	Step-Bolt Kit for 70' S1000 (4 welded sect & 3 screw-in)	336	
4.98.1100.070	Step-Bolt Kit for 70' S1100 (5 welded sect & 2 screw-in)	386	
4.98.S700.080	Step-Bolt Kit for 80' S700 (2 welded sect & 6 screw-in)	272	
4.98.S800.080	Step-Bolt Kit for 80' S800 (3 welded sect & 5 screw-in)	310	
4.98.S900.080	Step-Bolt Kit for 80' S900 (4 welded sect & 4 screw-in)	348	
4.98.1000.080	Step-Bolt Kit for 80' S1000 (5 welded sect & 3 screw-in)	386	
4.98.1100.080	Step-Bolt Kit for 80' S1100 (6 welded sect & 2 screw-in)	412	
4.98.S600.090	Step-Bolt Kit for 90' S600 (2 welded sect & 7 screw-in)	284	
4.98.S800.090	Step-Bolt Kit for 90' S800 (4 welded sect & 5 screw-in)	360	
4.98.S900.090	Step-Bolt Kit for 90' S900 (5 welded sect & 4 screw-in)	398	
4.98.1000.090	Step-Bolt Kit for 90' S1000 (6 welded sect & 3 screw-in)	436	
4.98.1100.090	Step-Bolt Kit for 90' S1100 (7 welded sect & 2 screw-in)	474	
4.98.S500.100	Step-Bolt Kit for 100' S500 (2 welded sect & 8 screw-in)	296	
4.98.S600.100	Step-Bolt Kit for 100' S600 (3 welded sect & 7 screw-in)	334	
4.98.S700.100	Step-Bolt Kit for 100' S700 (4 welded sect & 6 screw-in)	372	
4.98.S800.100	Step-Bolt Kit for 100' S800 (5 welded sect & 5 screw-in)	410	
4.98.S900.100	Step-Bolt Kit for 100' S900 (6 welded sect & 4 screw-in)	448	
4.98.1000.100	Step-Bolt Kit for 100' S1000 (7 welded sect & 3 screw-in)	486	
4.98.1100.100	Step-Bolt Kit for 100' S1100 (8 welded sect & 2 screw-in)	524	
4.98.S400.110	Step-Bolt Kit for 110' S400 (2 welded sect & 9 screw-in)	308	
4.98.S500.110	Step-Bolt Kit for 110' S500 (3 welded sect & 8 screw-in)	346	

Leg mounted & Screw-In Bolts used on sections # 1-12HD





Welded Sections used on sections #13-21

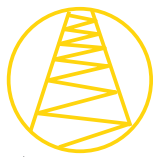



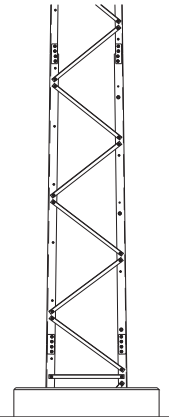

# SUPER TITAN™ KD Accessories – Climbing Step-Bolts

## Step-Bolt Climbing Kits *continued*

Part Number	Description	Ship Wt. (lbs)	Image
4.98.S600.110	Step-Bolt Kit for 110' S600 (4 welded sect & 7 screw-in)	384	  <i>Leg mounted &amp; Screw-In Bolts used on sections # 1-12HD</i>
4.98.S700.110	Step-Bolt Kit for 110' S700 (5 welded sect & 6 screw-in)	422	
4.98.S800.110	Step-Bolt Kit for 110' S800 (6 welded sect & 5 screw-in)	460	
4.98.S900.110	Step-Bolt Kit for 110' S900 (7 welded sect & 4 screw-in)	498	
4.98.1000.110	Step-Bolt Kit for 110' S1000 (8 welded sect & 3 screw-in)	536	
4.98.1100.110	Step-Bolt Kit for 110' S1100 (9 welded sect & 2 screw-in)	574	
4.98.S300.120	Step-Bolt Kit for 120' S300 (2 welded sect & 10 screw-in)	320	
4.98.S400.120	Step-Bolt Kit for 120' S400 (3 welded sect & 9 screw-in)	358	
4.98.S500.120	Step-Bolt Kit for 120' S500 (4 welded sect & 8 screw-in)	396	
4.98.S600.120	Step-Bolt Kit for 120' S600 (5 welded sect & 7 screw-in)	434	
4.98.S700.120	Step-Bolt Kit for 120' S700 (6 welded sect & 6 screw-in)	472	
4.98.S800.120	Step-Bolt Kit for 120' S800 (7 welded sect & 5 screw-in)	510	
4.98.S900.120	Step-Bolt Kit for 120' S900 (8 welded sect & 4 screw-in)	548	
4.98.1000.120	Step-Bolt Kit for 120' S1000 (9 welded sect & 3 screw-in)	586	
4.98.S300.130	Step-Bolt Kit for 130' S300 (3 welded sect & 10 screw-in)	370	
4.98.S400.130	Step-Bolt Kit for 130' S400 (4 welded sect & 9 screw-in)	408	
4.98.S500.130	Step-Bolt Kit for 130' S500 (5 welded sect & 8 screw-in)	446	
4.98.S600.130	Step-Bolt Kit for 130' S600 (6 welded sect & 7 screw-in)	484	
4.98.S700.130	Step-Bolt Kit for 130' S700 (7 welded sect & 6 screw-in)	522	
4.98.S800.130	Step-Bolt Kit for 130' S800 (8 welded sect & 5 screw-in)	560	
4.98.S900.130	Step-Bolt Kit for 130' S900 (9 welded sect & 4 screw-in)	598	
4.98.S300.140	Step-Bolt Kit for 140' S300 (4 welded sect & 10 screw-in)	420	  <i>Welded Sections used on sections #13-21</i>
4.98.S400.140	Step-Bolt Kit for 140' S400 (5 welded sect & 9 screw-in)	458	
4.98.S500.140	Step-Bolt Kit for 140' S500 (6 welded sect & 8 screw-in)	496	
4.98.S600.140	Step-Bolt Kit for 140' S600 (7 welded sect & 7 screw-in)	534	
4.98.S700.140	Step-Bolt Kit for 140' S700 (8 welded sect & 6 screw-in)	572	
4.98.S800.140	Step-Bolt Kit for 140' S800 (9 welded sect & 5 screw-in)	610	
4.98.S300.150	Step-Bolt Kit for 150' S300 (5 welded sect & 10 screw-in)	470	
4.98.S400.150	Step-Bolt Kit for 150' S400 (6 welded sect & 9 screw-in)	508	
4.98.S500.150	Step-Bolt Kit for 150' S500 (7 welded sect & 8 screw-in)	546	
4.98.S600.150	Step-Bolt Kit for 150' S600 (8 welded sect & 7 screw-in)	584	
4.98.S700.150	Step-Bolt Kit for 150' S700 (9 welded sect & 6 screw-in)	622	
4.98.S300.160	Step-Bolt Kit for 160' S300 (6 welded sect & 10 screw-in)	520	
4.98.S400.160	Step-Bolt Kit for 160' S400 (7 welded sect & 9 screw-in)	558	
4.98.S500.160	Step-Bolt Kit for 160' S500 (8 welded sect & 8 screw-in)	596	
4.98.S600.160	Step-Bolt Kit for 160' S600 (9 welded sect & 7 screw-in)	634	
4.98.S300.170	Step-Bolt Kit for 170' S300 (7 welded sect & 10 screw-in)	570	
4.98.S400.170	Step-Bolt Kit for 170' S400 (8 welded sect & 9 screw-in)	608	
4.98.S500.170	Step-Bolt Kit for 170' S500 (9 welded sect & 8 screw-in)	646	
4.98.S300.180	Step-Bolt Kit for 180' S300 (8 welded sect & 10 screw-in)	620	
4.98.S400.180	Step-Bolt Kit for 180' S400 (9 welded sect & 9 screw-in)	658	
4.98.S300.190	Step-Bolt Kit for 190' S300 (9 welded sect & 10 screw-in)	670	

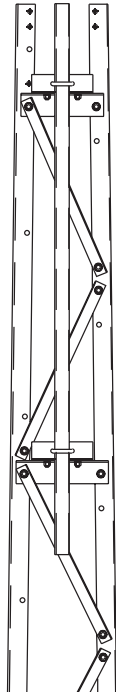

<b>Antenna Face Mount Kits (6' long pipe in a variety of diameters)</b>			
<b>Part Number</b>	<b>Description</b>	<b>Ship Wt. (lbs)</b>	<b>Image</b>
4.84.0001.001	Antenna Face Mount Kit - fits section # 1, 1.9"OD pipe	30	
4.84.0001.002	Antenna Face Mount Kit - fits section # 2, 1.9"OD pipe	30	
4.84.0001.003	Antenna Face Mount Kit - fits section # 3, 1.9"OD pipe	30	
4.84.0001.004	Antenna Face Mount Kit - fits section # 4, 1.9"OD pipe	35	
4.84.0001.005	Antenna Face Mount Kit - fits section # 5, 1.9"OD pipe	35	
4.84.0001.006	Antenna Face Mount Kit - fits section # 6, 1.9"OD pipe	40	
4.84.0001.007	Antenna Face Mount Kit - fits section # 7, 1.9"OD pipe	40	
4.84.0001.008	Antenna Face Mount Kit - fits section # 8, 1.9"OD pipe	45	
4.84.0001.009	Antenna Face Mount Kit - fits section # 9, 1.9"OD pipe	48	
4.84.0001.010	Antenna Face Mount Kit - fits section #10, 1.9"OD pipe	53	
4.84.0001.011	Antenna Face Mount Kit - fits section #11, 1.9"OD pipe	58	
4.84.0001.012	Antenna Face Mount Kit - fits section #12, 1.9"OD pipe	70	
4.84.0002.005	# 5 Face Mount Kit with 2 3/8"OD x 6' long pipe	140	
4.84.0002.006	# 6 Face Mount Kit with 2 3/8"OD x 6' long pipe	145	
4.84.0002.007	# 7 Face Mount Kit with 2 3/8"OD x 6' long pipe	150	
4.84.0006.001	SuperTitan Antenna Face Mount Kit - fits section # 1, 4.5"OD pipe	90	
4.84.0006.002	SuperTitan Antenna Face Mount Kit - fits section # 2, 4.5"OD pipe	92	
4.84.0006.003	SuperTitan Antenna Face Mount Kit - fits section # 3, 4.5"OD pipe	94	
4.84.0006.004	SuperTitan Antenna Face Mount Kit - fits section # 4, 4.5"OD pipe	95	
4.84.0006.005	SuperTitan Antenna Face Mount Kit - fits section # 5, 4.5"OD pipe	97	
4.84.0006.006	SuperTitan Antenna Face Mount Kit - fits section # 6, 4.5"OD pipe	99	
4.84.0006.007	SuperTitan Antenna Face Mount Kit - fits section # 7, 4.5"OD pipe	102	
4.84.0006.008	SuperTitan Antenna Face Mount Kit - fits section # 8, 4.5"OD pipe	103	
4.84.0006.009	SuperTitan Antenna Face Mount Kit - fits section # 9, 4.5"OD pipe	104	
4.84.0006.010	SuperTitan Antenna Face Mount Kit - fits section #10, 4.5"OD pipe	106	
4.84.0006.011	SuperTitan Antenna Face Mount Kit - fits section #11, 4.5"OD pipe	108	
4.84.0006.012	SuperTitan Antenna Face Mount Kit - fits section #12, 4.5"OD pipe	110	



<b>Antenna Face Mount Kits (10' long pipe)</b>			
<b>Part Number</b>	<b>Description</b>	<b>Ship Wt. (lbs)</b>	<b>Image</b>
4.84.0002.105	# 5 Face Mount Kit w/ 2 3/8"OD x 10' pipe, adjusts for tower taper	175	
4.84.0002.106	# 6 Face Mount Kit w/ 2 3/8"OD x 10' pipe, adjusts for tower taper	180	

<b>Universal Face Mounts</b>			
<b>Part Number</b>	<b>Description</b>	<b>Ship Wt. (lbs)</b>	<b>Image</b>
4.84.0002.301	Antenna Face Mount w/ 2 3/8"x 6' pipe - fits section # 1 to 3	47	
4.84.0002.302	Antenna Face Mount w/ 2 3/8"x 6' pipe - fits section # 3 to 7	53	
4.84.0002.303	Antenna Face Mount w/ 2 3/8"x 6' pipe - fits section # 7 to 9	57	

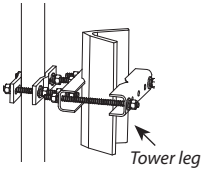
**Antenna Leg Mounts** (fit all SuperTitan legs; accomodates tower taper)

Part Number	Description	Ship Wt. (lbs)	Image
4.84.2702.215	Antenna Leg Mount c/w 1.9"OD x 6' pipe	120	 <p>Tower leg</p>
4.84.2702.220	Antenna Leg Mount c/w 2.375"OD x 6' pipe	130	
4.84.2702.225	Antenna Leg Mount c/w 2.875"OD x 6' pipe	140	
4.84.2702.230	Antenna Leg Mount c/w 3.5"OD x 6' pipe	150	
4.84.2702.235	Antenna Leg Mount c/w 4"OD x 6' pipe	160	

**Cluster Antenna Mounts**

Part Number	Description	Ship Wt. (lbs)	Image
4.84.3CLS.00A	3-cluster Antenna Mount, 1.66" OD tube	40	 <p>3-cluster Antenna Mount</p>  <p>6-cluster Antenna Mount</p>
4.84.6CLS.00A	6-cluster Antenna Mount, 1.66" OD tube	80	

**Light Stand-Off Antenna Mounts**

Part Number	Description	Ship Wt. (lbs)	Image
5.930.0202.002	2' Stand-Off with Small Backing Kits – follows tower taper	42	
5.930.0202.022	2' Stand-Off with Universal Backing Kits – adjusts for tower taper	56	
5.930.0203.002	3' Stand-Off with Small Backing Kits – follows tower taper	46	
5.930.0203.022	3' Stand-Off with Universal Backing Kits – adjusts for tower taper	48	
5.930.0205.022	5' Stand-Off with Universal Backing Kits – adjusts for tower taper	87	
5.930.0205.002	5' Stand-Off with Small Backing Kits – follows tower taper	78	
5.930.0206.002	6' Stand-Off with Small Backing Kits – follows tower taper	87	

Note: The additional projected area created by the mounts themselves must be taken into consideration for wind load considerations. The offset distance must also be considered.

Camera Mount (for top of tower)				
Part Number	Description	Ship Wt. (lbs)	Ship LxWxH (in)	Image
4.85.0102.000	SuperTitan Camera Mount - surveillance	28	60x12x12	

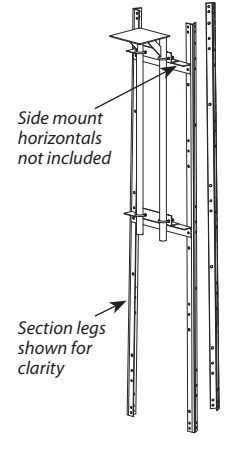
Camera Mount (for side mounting below the tower top)				
Part Number	Description	Ship Wt. (lbs)	Ship LxWxH (in)	Image
4.85.0103.001	SuperTitan Camera Side Mount - surveillance	65	60x12x12	 <p>Side mount horizontals not included</p> <p>Section legs shown for clarity</p>

Factory Painted Towers - Orange & White, Water-Based (applied by spray gun in factory; kit includes extra paint for touch-ups)	
Paint pricing available upon request, please contact your Trylon distributor.	
	

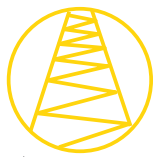

### Base Feet Kits less Anchor Bolts (includes base feet, horizontal support brace, and positioning template)

Part Number	Description	Ship Wt. (lbs)	Image
4.79.0000.304	Base Feet, 3-Pak, no anchors - fits SuperTitan section #3	160	
4.79.0000.305	Base Feet, 3-Pak, no anchors - fits SuperTitan section #4	160	
4.79.0000.306	Base Feet, 3-Pak, no anchors - fits SuperTitan section #5	198	
4.79.0000.307	Base Feet, 3-Pak, no anchors - fits SuperTitan section #6	215	
4.79.0000.308	Base Feet, 3-Pak, no anchors - fits SuperTitan section #7	215	
4.79.0000.309	Base Feet, 3-Pak, no anchors - fits SuperTitan section #8	215	
4.79.0000.310	Base Feet, 3-Pak, no anchors - fits SuperTitan section #9	215	
4.79.0000.311	Base Feet, 3-Pak, no anchors - fits SuperTitan section #10	230	
4.79.0000.312	Base Feet, 3-Pak, no anchors - fits SuperTitan section #11	230	
4.79.0000.312HD	Base Feet, 3-Pak, no anchors - fits SuperTitan section #11HD	240	
4.79.0000.313	Base Feet, 3-Pak, no anchors - fits SuperTitan section #12	230	
4.79.0000.313HD	Base Feet, 3-Pak, no anchors - fits SuperTitan section #12HD	240	
4.79.0000.315	Base Feet, 3-Pak, no anchors - fits SuperTitan section #14	770	
4.79.0000.316	Base Feet, 3-Pak, no anchors - fits SuperTitan section #15	770	
4.79.0000.317	Base Feet, 3-Pak, no anchors - fits SuperTitan section #16	770	
4.79.0000.318	Base Feet, 3-Pak, no anchors - fits SuperTitan section #17	770	
4.79.0000.319	Base Feet, 3-Pak, no anchors - fits SuperTitan section #18	800	
4.79.0000.320	Base Feet, 3-Pak, no anchors - fits SuperTitan section #19	800	
4.79.0000.321	Base Feet, 3-Pak, no anchors - fits SuperTitan section #20	800	
4.79.0000.322	Base Feet, 3-Pak, no anchors - fits SuperTitan section #21	800	

### Base Feet Kit with Rock Bolts (includes template for anchors, keyhole plate)

Part Number	Description	Ship Wt. (lbs)	Image
4.79.0000.104	Base Feet Kit with 5/8" x 98" Rock Bolts - fits SuperTitan # 3	266	
4.79.0000.105	Base Feet Kit with 5/8" x 98" Rock Bolts - fits SuperTitan # 4	266	
4.79.0000.106	Base Feet Kit with 7/8" x 122" Rock Bolts - fits SuperTitan # 5	400	
4.79.0000.107	Base Feet Kit with 7/8" x 122" Rock Bolts - fits SuperTitan # 6	425	
4.79.0000.108	Base Feet Kit with 7/8" x 122" Rock Bolts - fits SuperTitan # 7	425	
4.79.0000.109	Base Feet Kit with 7/8" x 122" Rock Bolts - fits SuperTitan # 8	425	
4.79.0000.110	Base Feet Kit with 7/8" x 122" Rock Bolts - fits SuperTitan # 9	430	
4.79.0000.111	Base Feet Kit with 7/8" x 122" Rock Bolts - fits SuperTitan #10	470	
4.79.0000.112	Base Feet Kit with 7/8" x 122" Rock Bolts - fits SuperTitan #11	470	
4.79.0000.112HD	Base Feet Kit with 7/8" x 122" Rock Bolts - fits SuperTitan #11HD	480	
4.79.0000.113	Base Feet Kit with 7/8" x 122" Rock Bolts - fits SuperTitan #12	475	
4.79.0000.113HD	Base Feet Kit with 7/8" x 122" Rock Bolts - fits SuperTitan #12HD	485	
4.79.0000.115	Base Feet Kit with 1" x 128" Rock Bolts - fits SuperTitan #14	1,015	
4.79.0000.116	Base Feet Kit with 1" x 128" Rock Bolts - fits SuperTitan #15	1,020	
4.79.0000.117	Base Feet Kit with 1" x 128" Rock Bolts - fits SuperTitan #16	1,020	
4.79.0000.118	Base Feet Kit with 1" x 128" Rock Bolts - fits SuperTitan #17	1,020	
4.79.0000.119	Base Feet Kit with 1" x 128" Rock Bolts - fits SuperTitan #18	1,050	
4.79.0000.120	Base Feet Kit with 1" x 128" Rock Bolts - fits SuperTitan #19	1,050	
4.79.0000.121	Base Feet Kit with 1" x 128" Rock Bolts - fits SuperTitan #20	1,050	
4.79.0000.122	Base Feet Kit with 1" x 128" Rock Bolts - fits SuperTitan #21	1,050	

Note: Rock bolts above are suitable provided the following rock conditions exist:

- 1) Rock quality – RQD 90% or better
- 2) Rock unit weight – 180 pcf
- 3) Exposed rock at surface (max 6" of earth cover)

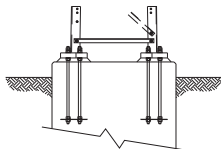
<b>Base Feet Kit with Tie-rods</b> (alternative to 5' embedment section - for new concrete pours)			
Part Number	Description	Ship Wt. (lbs)	Image
4.79.0000.004	Base Feet Kit with 5/8" x 30" Anchor Bolts - fits SuperTitan # 3	156	
4.79.0000.005	Base Feet Kit with 5/8" x 30" Anchor Bolts - fits SuperTitan # 4	160	
4.79.0000.006	Base Feet Kit with 7/8" x 30" Anchor Bolts - fits SuperTitan # 5	198	
4.79.0000.007	Base Feet Kit with 7/8" x 30" Anchor Bolts - fits SuperTitan # 6	228	
4.79.0000.008	Base Feet Kit with 7/8" x 30" Anchor Bolts - fits SuperTitan # 7	232	
4.79.0000.009	Base Feet Kit with 7/8" x 30" Anchor Bolts - fits SuperTitan # 8	230	
4.79.0000.010	Base Feet Kit with 7/8" x 30" Anchor Bolts - fits SuperTitan # 9	232	
4.79.0000.011	Base Feet Kit with 7/8" x 30" Anchor Bolts - fits SuperTitan #10	238	
4.79.0000.012	Base Feet Kit with 7/8" x 30" Anchor Bolts - fits SuperTitan #11	238	
4.79.0000.012HD	Base Feet Kit with 7/8" x 30" Anchor Bolts - fits SuperTitan #11HD	250	
4.79.0000.013	Base Feet Kit with 7/8" x 30" Anchor Bolts - fits SuperTitan #12	238	
4.79.0000.013HD	Base Feet Kit with 7/8" x 30" Anchor Bolts - fits SuperTitan #12HD	250	
4.79.0000.015	Base Feet Kit with Anchor Bolts - fits SuperTitan #14 sect	702	
4.79.0000.016	Base Feet Kit with Anchor Bolts - fits SuperTitan #15 sect	710	
4.79.0000.017	Base Feet Kit with Anchor Bolts - fits SuperTitan #16 sect	717	
4.79.0000.018	Base Feet Kit with Anchor Bolts - fits SuperTitan #17 sect	724	
4.79.0000.019	Base Feet Kit with Anchor Bolts - fits SuperTitan #18 sect	753	
4.79.0000.020	Base Feet Kit with Anchor Bolts - fits SuperTitan #19 sect	775	
4.79.0000.021	Base Feet Kit with Anchor Bolts - fits SuperTitan #20 sect	782	
4.79.0000.022	Base Feet Kit with Anchor Bolts - fits SuperTitan #21 sect	789	

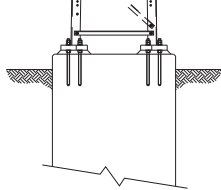
<b>Base Feet Kit with Hilti Bolts</b> (includes pouches of adhesive compound for grouting in anchor bolts - for existing concrete pads and roofs)			
Part Number	Description	Ship Wt. (lbs)	Image
4.79.0000.204	Base Feet Kit with 5/8" x 15" Hilti Bolts - fits SuperTitan # 3	110	
4.79.0000.205	Base Feet Kit with 5/8" x 15" Hilti Bolts - fits SuperTitan # 4	113	
4.79.0000.206	Base Feet Kit with 7/8" x 20" Hilti Bolts - fits SuperTitan # 5	153	
4.79.0000.207	Base Feet Kit with 7/8" x 24" Hilti Bolts - fits SuperTitan # 6	187	
4.79.0000.208	Base Feet Kit with 7/8" x 24" Hilti Bolts - fits SuperTitan # 7	192	
4.79.0000.209	Base Feet Kit with 7/8" x 24" Hilti Bolts - fits SuperTitan # 8	195	
4.79.0000.210	Base Feet Kit with 7/8" x 24" Hilti Bolts - fits SuperTitan # 9	197	
4.79.0000.211	Base Feet Kit with 7/8" x 24" Hilti Bolts - fits SuperTitan #10	201	
4.79.0000.212	Base Feet Kit with 7/8" x 24" Hilti Bolts - fits SuperTitan #11	200	
4.79.0000.212HD	Base Feet Kit with 7/8" x 24" Hilti Bolts - fits SuperTitan #11HD	210	
4.79.0000.213	Base Feet Kit with 7/8" x 24" Hilti Bolts - fits SuperTitan #12	201	
4.79.0000.213HD	Base Feet Kit with 7/8" x 24" Hilti Bolts - fits SuperTitan #12HD	211	
4.79.0000.215	Base Feet Kit with 1" x 30" Hilti Bolts - fits SuperTitan #14	790	
4.79.0000.216	Base Feet Kit with 1" x 30" Hilti Bolts - fits SuperTitan #15	800	
4.79.0000.217	Base Feet Kit with 1" x 30" Hilti Bolts - fits SuperTitan #16	800	
4.79.0000.218	Base Feet Kit with 1" x 30" Hilti Bolts - fits SuperTitan #17	800	
4.79.0000.219	Base Feet Kit with 1" x 30" Hilti Bolts - fits SuperTitan #18	800	
4.79.0000.220	Base Feet Kit with 1" x 30" Hilti Bolts - fits SuperTitan #19	845	
4.79.0000.221	Base Feet Kit with 1" x 30" Hilti Bolts - fits SuperTitan #20	845	
4.79.0000.222	Base Feet Kit with 1" x 30" Hilti Bolts - fits SuperTitan #21	845	

### Basic Light Kit *(dual obstruction red lights, non-alarmed, steady burning, no photocell, c/w lights, cable, connectors, ty wraps, etc.)*

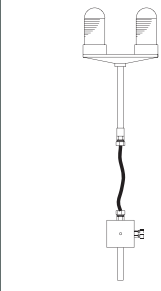
Part Number	Description	Ship Wt. (lbs)*	Image
4.93.0200.150	Basic DOL Light Kit, 0 to 150' towers	60	
<p>* Packaging includes three pieces: one box with lights only (20"L x 8"W x 10"H), one reel of tech cable (24"OD x 12"H), and one box of all other components (8"L x 8"W x 16"H).</p>			

### Light Kit with Photocell *(non-alarmed, c/w red lights, cable, connectors, ty wraps, etc.)*

Part Number	Description	Ship Wt. (lbs)	Image
4.93.STPH.150	0-150' DOL Light Kit	90	
4.93.STPH.190	160-190' Beacon Light Kit	130	

### Light Kit with Alarmed Controller and Photocell *(c/w red lights, cable, connectors, ty wraps, etc.)*

Part Number	Description	Ship Wt. (lbs)	Image
4.93.STAL.150	0-150' DOL Light Kit	100	
4.93.STAL.190	160-190' Beacon Light Kit	140	

### White Strobe Light Kit *(medium intensity, c/w cable, connectors, etc., no mid DOL)*

Part Number	Description	Ship Wt. (lbs)	Image
4.93.STWS.100	SuperTitan White Strobe Kit, 0 to 100' towers	145	
4.93.STWS.190	SuperTitan White Strobe Kit, 101' to 190' towers	160	

### 48VDC LED Light Kit with Photocell *(ideal for sites powered by solar energy)*

Part Number	Description	Ship Wt. (lbs)	Image
4.93.LED1.150	0'-150' LED dual obstruction light kit, photocell, no SOL	150	
4.93.LED3.200	160'-190' LED beacon light kit, photocell, two LED SOL	180	

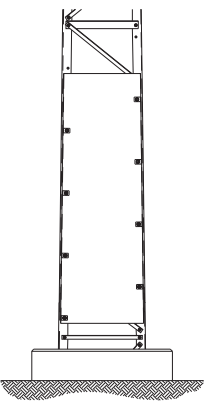

Anti-Climb Shield Kits			
Part Number	Description	Ship Wt. (lbs)	Image
4.92.0001.002	Anti-Climb Shield Kit - SuperTitan section # 2	100	
4.92.0001.003	Anti-Climb Shield Kit - SuperTitan section # 3	110	
4.92.0001.004	Anti-Climb Shield Kit - SuperTitan section # 4	122	
4.92.0001.005	Anti-Climb Shield Kit - SuperTitan section # 5	133	
4.92.0001.006	Anti-Climb Shield Kit - SuperTitan section # 6	145	
4.92.0001.007	Anti-Climb Shield Kit - SuperTitan section # 7	160	
4.92.0001.008	Anti-Climb Shield Kit - SuperTitan section # 8	172	
4.92.0001.009	Anti-Climb Shield Kit - SuperTitan section # 9	185	
4.92.0001.010	Anti-Climb Shield Kit - SuperTitan section #10	197	
4.92.0001.011	Anti-Climb Shield Kit - SuperTitan section #11 & #11HD	208	
4.92.0001.012	Anti-Climb Shield Kit - SuperTitan section #12 & #12HD	225	
4.92.0001.213	Anti-Climb Mesh - SuperTitan sect. #13 to #21 (1 leg w/ step-bolt) <i>Note: This does not cover the entire tower face, it only prevents access to the step-bolt ladder on one leg.</i>	242	

Note: Please see page 75 for Anti-Climb Shield Kit installation.

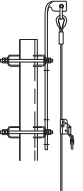
Cable Safety Climb Kits			
Part Number	Description	Ship Wt. (lbs)	Image
4.99.0485.050	Cable Safety Climb Kit (no slider): up to 50' SuperTitan towers	85	
4.99.0485.100	Cable Safety Climb Kit (no slider): 60' to 100' SuperTitan towers	110	
4.99.0485.150	Cable Safety Climb Kit (no slider): 110' to 150' SuperTitan towers	130	
4.99.0485.190	Cable Safety Climb Kit (no slider): 160' to 190' SuperTitan towers	147	
4.99.0101.001	Cougar Safety Cable Slider and Karabiner	4	

Note: Please visit [www.trylon.com](http://www.trylon.com) for full Safety Cable installation.

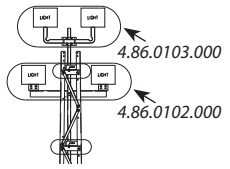
Flood Light Support Mounts			
Part Number	Description	Ship Wt. (lbs)	Image
4.86.0102.000	Dual Mount Angle Floodlight Support	12	
4.86.0103.000	Dual Mount Bullhorn Floodlight Support	40	

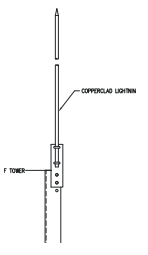
Lightning Rod			
Part Number	Description	Ship Wt. (lbs)	Image
4.90.0200.C05	SuperTitan Lightning Rod, 5' long, copper-clad	20	

## Mounting Pipes

Part Number	Description	Ship Wt. (lbs)	Image
4.87.0101.000	1.9"OD x 6' Galvanized Tubing - 0.625"ID	14	
4.87.0101.100	1.9"OD x 8' Galvanized Tubing - 0.625"ID	18	
4.87.0101.200	1.9"OD x 10' Galvanized Tubing - 0.625"ID	23	
4.87.0101.300	1.9"OD x 12' Galvanized Tubing - 0.625"ID	28	
4.87.0101.350	1.9"OD x 20' Galvanized Tubing - 0.625"ID	46	
4.87.0102.000	2.375"OD x 6' Galvanized Tubing - 0.188" THK	28	
4.87.0102.100	2.375"OD x 8' Galvanized Tubing - 0.188" THK	37	
4.87.0102.200	2.375"OD x 10' Galvanized Tubing - 0.188" THK	46	
4.87.0102.300	2.375"OD x 12' Galvanized Tubing - 0.188" THK	55	
4.87.0102.400	2.375"OD x 20' Galvanized Tubing - 0.188" THK	92	
4.87.0103.000	2.875"OD Tubing - Mounting Pipe 6' galvanized	40	
4.87.0103.100	2.875"OD Tubing - Mounting Pipe 8' galvanized	45	
4.87.0103.200	2.875"OD Tubing - Mounting Pipe 10' galvanized	55	
4.87.0103.300	2.875"OD Tubing - Mounting Pipe 12' galvanized	65	
4.87.0103.400	2.875"OD Tubing - Mounting Pipe 20' galvanized	115	
4.87.0103.500	2.875"OD Tubing - Mounting Pipe 24' galvanized	130	
4.87.0104.101	4"OD x 6' Mounting Pipe - 0.25" THK, HDG	55	
4.87.0104.201	4"OD x 8' Mounting Pipe - 0.25" THK, HDG	65	
4.87.0104.301	4"OD x 10' Mounting Pipe - 0.25" THK, HDG	90	
4.87.0104.401	4"OD x 12' Mounting Pipe - 0.25" THK, HDG	110	
4.87.0104.501	4"OD x 20' Mounting Pipe - 0.25" THK, HDG	180	
4.87.0104.601	4"OD x 24' Mounting Pipe - 0.25" THK, HDG	220	
4.87.0104.400	4.5"OD x 6' Mounting Pipe - 0.25" THK, HDG	72	
4.87.0104.500	4.5"OD x 10' Mounting Pipe - 0.25" THK, HDG	120	
4.87.0104.600	4.5"OD x 12' Mounting Pipe - 0.25" THK, HDG	144	
4.87.0104.700	4.5"OD x 20' Mounting Pipe - 0.25" THK, HDG	240	
4.87.0104.800	4.5"OD x 24' Mounting Pipe - 0.25" THK, HDG	288	

## Tx Transmission Line Brackets (for sections # 1 to 12HD order three pieces per section; for #13 to 21 order four pieces per section)

Part Number	Description	Ship Wt. (lbs)	Image
4.84.0300.100	4 Line Tx Bracket (single pak) - 4 lines maximum	2	 Tower Leg
4.84.0300.300	8 Line Tx Bracket (single pak) - for angle ladder #4.98.0300.010 only	2	

## Work Platform

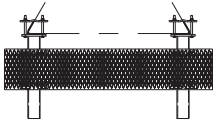
Part Number	Description	Ship Wt. (lbs)	Image
4.88.0200.000	SuperTitan Work Platform - fits sections # 1 to 12HD	89	

## Rest Platform

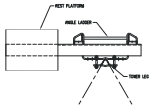
Part Number	Description	Ship Wt. (lbs)	Image
4.88.0300.000	Small Rest Platform for ladder use - warm climates only where icing does not occur	89	

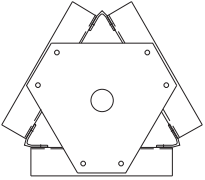

Note: This platform is designed for mounting on the SuperTitan apex climbing ladder #4.98.0300.010.

Thrust Bearing				
Part Number	Description	Ship Wt. (lbs)	Ship LxWxH (in)	Image
4.600.2703.001	TB3 Thrust Bearing – supports up to 2"OD Mast	4	8x8x8	
4.600.2704.001	TB4 Thrust Bearing – supports up to 3"OD Mast	4	8x8x8	

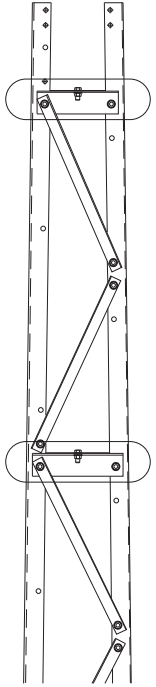
Rotor Plates <i>(Rotor Plates are installed by attaching to Angle Frames - see below)</i>				
Part Number	Description	Ship Wt. (lbs)	Image	
4.89.0001.001	Upper Rotor Plates for SuperTitan section # 1	14		
4.89.0001.002	Mid-level Rotor Plates for SuperTitan section # 1	14		
4.89.0002.001	Upper Rotor Plates for SuperTitan section # 2	16		
4.89.0002.002	Mid-level Rotor Plates for SuperTitan section # 2	16		
4.89.0003.001	Upper Rotor Plates for SuperTitan section # 3	17		
4.89.0003.002	Mid-level Rotor Plates for SuperTitan section # 3	17		
4.89.0004.001	Upper Rotor Plates for SuperTitan section # 4	18		
4.89.0004.002	Mid-level Rotor Plates for SuperTitan section # 4	18		
4.89.0005.001	Upper Rotor Plates for SuperTitan section # 5	19		
4.89.0005.002	Mid-level Rotor Plates for SuperTitan section # 5	19		
4.89.0006.001	Upper Rotor Plates for SuperTitan section # 6	20		
4.89.0006.002	Mid-level Rotor Plates for SuperTitan section # 6	20		
4.89.0007.001	Upper Rotor Plates for SuperTitan section # 7	21		
4.89.0007.002	Mid-level Rotor Plates for SuperTitan section # 7	21		

Pipe Mount Kits - Angle Frames <i>(SuperTitan Top Sections include one upper and one lower Angle Frame)</i>				
Part Number	Description	Ship Wt. (lbs)	Image	
4.83.0002.001	Upper Pipe Mount Kit for SuperTitan section # 2	23		
4.83.0002.002	Lower Pipe Mount Kit for SuperTitan section # 2	23		
4.83.0003.001	Upper Pipe Mount Kit for SuperTitan section # 3	28		
4.83.0003.002	Lower Pipe Mount Kit for SuperTitan section # 3	28		
4.83.0004.001	Upper Pipe Mount Kit for SuperTitan section # 4	31		
4.83.0004.002	Lower Pipe Mount Kit for SuperTitan section # 4	31		
4.83.0005.001	Upper Pipe Mount Kit for SuperTitan section # 5	35		
4.83.0005.002	Lower Pipe Mount Kit for SuperTitan section # 5	35		
4.83.0006.001	Upper Pipe Mount Kit for SuperTitan section # 6	38		
4.83.0006.002	Lower Pipe Mount Kit for SuperTitan section # 6	38		
4.83.0007.001	Upper Pipe Mount Kit for SuperTitan section # 7	41		
4.83.0007.002	Lower Pipe Mount Kit for SuperTitan section # 7	41		
4.83.0008.001	Upper Pipe Mount Kit for SuperTitan section # 8	43		
4.83.0008.002	Lower Pipe Mount Kit for SuperTitan section # 8	43		
4.83.0009.001	Upper Pipe Mount Kit for SuperTitan section # 9	48		
4.83.0009.002	Lower Pipe Mount Kit for SuperTitan section # 9	48		
4.83.0010.001	Upper Pipe Mount Kit for SuperTitan section #10	51		
4.83.0010.002	Lower Pipe Mount Kit for SuperTitan section #10	51		
4.83.0011.001	Upper Pipe Mount Kit for SuperTitan section #11	53		
4.83.0011.002	Lower Pipe Mount Kit for SuperTitan section #11	53		
4.83.0012.001	Upper Pipe Mount Kit for SuperTitan section #12	58		
4.83.0012.002	Lower Pipe Mount Kit for SuperTitan section #12	58		

### Waveguide Bridge - 10' length (has twenty-four 7/16" holes and twenty 3/4" holes)

Part Number	Description	Ship Wt. (lbs)	Image
5.939.0112.001	One 18" x 10' Solid Cover c/w two 3-1/2" x 14' Direct Burial Posts and three 2-rung trapezes	403	 <p>5.939.0112.001</p>  <p>5.939.0113.001</p>
5.939.0113.001	One 18" x 10' Solid Cover c/w two 3-1/2" x 10-1/2' Base Shoe Posts and three 2-rung trapezes	385	

### Waveguide Bridge - 20' length (holds maximum 12 lines, assuming four bolt-on hangers are used)

Part Number	Description	Ship Wt. (lbs)	Image
5.939.0703.001	20' Bridge c/w 3 posts, 6 double trapezes	500	

### Tower Grounding Kit

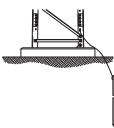
Part Number	Description	Ship Wt. (lbs)	Image
4.91.0103.000	SuperTitan Basic Grounding Kit, 1 leg (# 1 to #12 only)	15	
4.91.0103.003	STSS EIA Compliant Grounding Kit, 3 leg (#13 to #21 only) <i>Includes Tinned Copper Wire</i>	65	

### External Climbing Ladder Kits (pre-kitted assemblies utilize both the Climbing Ladder Bracket kits in conjunction with our solid round ladders)

Part Number	Description	Ship Wt. (lbs)	Image
<i>S/R Climbing Ladder Kits with Small Backing Assemblies (SBA) fits sections 1 - 12</i>			 <p>5.918.0110.001 10' S/R Ladder with three Small Backing Kits</p>
5.918.0105.001	5' S/R Ladder with 2 SBA kits	50	
5.918.0110.001	10' S/R Ladder with 3 SBA kits	89	
5.918.0115.001	15' S/R Ladder with 5 SBA kits	138	
5.918.0120.001	20' S/R Ladder with 6 SBA kits	177	
<i>S/R Climbing Ladder Kits with Large Backing Assemblies (LBA) fits sections 13 - 21</i>			
5.918.0105.002	5' S/R Ladder with 2 LBA kits	57	
5.918.0110.002	10' S/R Ladder with 3 LBA kits	99	
5.918.0115.002	15' S/R Ladder with 5 LBA kits	156	
5.918.0120.002	20' S/R Ladder with 6 LBA kits	198	198

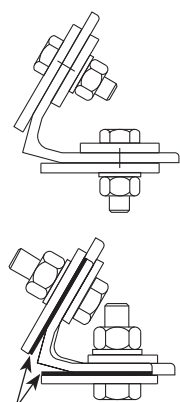
<b>Splice Plates</b> (individual quantities, not 3-paks, splice bolts not included)			
Part Number	Description	Ship Wt. (lbs)	Image
3.924.0060.001	Outer Splice Plate - sections 18/19/20/21	5	 <p>Filler Plate 3.924.01453.003</p>
3.924.0060.002	Inner Splice Plate - sections 18/19/20/21	5	
3.924.0151.001	Outer Splice Plate - sections 13/14/15/16/17	5	
3.924.0151.002	Inner Splice Plate - sections 13/14/15/16/17	3	
3.924.0152.001	Outer Splice Plate - sections # 1-2, 2-3, 3-4 and 4-5 (Qty 1)	3	
3.924.0152.002	Inner Splice Plate - sections # 1-2, 2-3, 3-4 and 4-5 (Qty 1)	2	
3.924.0153.001	Outer Splice Plate - section # 5-6	2	
3.924.0153.002	Inner Splice Plate - section # 5-6	1	
3.924.0153.003	Filler Plate - section # 5-6	3	
3.924.0154.001	Outer Splice Plate - section # 6-7	3	
3.924.0154.002	Inner Splice Plate - section # 6-7	2	
3.924.0155.001	Outer Splice Plate - sections # 7-8, 8-9 and 9-10 (Qty 1)	3	
3.924.0155.002	Inner Splice Plate - sections # 7-8, 8-9 and 9-10 (Qty 1)	2	
3.924.0156.001	Outer Splice Plate - section #10-11	3	
3.924.0156.002	Inner Splice Plate - section #10-11	2	
3.924.0157.001	Outer Splice Plate - sections #11-12 and 12-13F (Qty 1)	2	
3.924.0157.002	Inner Splice Plate - sections #11-12 and 12-13F (Qty 1)	2	
3.924.0177.001	Top Outer Splice Plate - section #13	4	
3.924.0177.002	Top Inner Splice Plate - section #13	4	

<b>Splice Bolts</b> (for connecting section legs together (20/package))			
Part Number	Description	Ship Wt. (lbs)	Image
5.1202021	1/2" x 1-1/2" A325 Bolt Assembly (20/pkg)	5	
5.1202022	1/2" x 1-3/4" A325 Bolt Assembly (20/pkg)	5	
5.1202024	1/2" x 2-1/4" A325 Bolt Assembly - HDG (20/pkg)	5	
5.1202043	5/8" x 2" A325 Bolt Assembly (20 pkg)	6	
5.1202044	5/8" x 2-1/4" A325 Bolt Assembly (20/pkg)	6	
5.1212061	3/8" x 2" x 2" Spacer 11/16" Hole - HDG (20/pkg)	2	
5.1202180	1/2" A563 DH Hex Nut - HDG (20/pkg)	2	
5.1202211	1/2" F-436 Flat Washer - HDG (20/pkg)	2	
5.1202212	5/8" F-436 Flat Washer - HDG (20/pkg)	2	

<b>Replacement Tower Legs</b>			
Part Number	Description	Ship Wt. (lbs)	Image
3.620.0001.001	Angle Leg for sections # 1/3/5	5	
3.620.0002.001	Angle Leg for sections # 2/4	5	
3.620.0003.001	Angle Leg for section # 6	6	
3.620.0004.001	Angle Leg for section # 7	7	
3.620.0005.001	Angle Leg for sections # 8/10	7	
3.620.0006.001	Angle Leg for section # 9	7	
3.620.0007.001	Angle Leg for section #11	8	
3.620.0008.001	Angle Leg for section #12	8	
3.620.0032.001	Angle Leg for section #11HD	10	
3.620.0033.001	Angle Leg for section #12HD	10	
3.620.0064.001	Angle Leg for sections #13/14/15/16/17	11	
3.620.0063.001	Angle Leg for sections #18/19/20/21	13	



## Connection Plates

Part Number	Description	Ship Wt. (lbs)	Image
3.620.0067.001	Connection Plate (section #21)	47	
3.620.0067.002	Connection Plate (section #20)	44	
3.620.0067.003	Connection Plate (section #19)	42	
3.620.0067.004	Connection Plate (section #18)	40	
3.620.0068.001	Connection Plate (section #17)	34	
3.620.0068.002	Connection Plate (section #16)	35	
3.620.0068.003	Connection Plate (section #15)	32	
3.620.0068.004	Connection Plate (section #14)	30	
3.620.0068.005	Connection Plate (section #13)	30	

## 5' Foundation Section Components

Part Number	Description	Ship Wt. (lbs)
3.620.0009.001	Stub Leg for sections 2F/4F	16
3.620.0010.001	Stub Leg for sections 3F/5F	16
3.620.0011.001	Stub Leg for section 6F	25
3.620.0012.001	Stub Leg for sections 7F/9F	29
3.620.0013.001	Stub Leg for sections 8F/10F	29
3.620.0014.001	Stub Leg for section 11F	35
3.620.0015.001	Stub Leg for section 12F	33
3.620.0021.001	Stub Leg for section 13F	35
3.620.0035.001	Stub Leg for section 13HDF	43
3.620.0017.001	Diagonal 2F	4
3.620.0017.002	Diagonal 3F	4
3.620.0017.003	Diagonal 4F	4
3.620.0017.004	Diagonal 5F	4
3.620.0017.005	Diagonal 6F	5
3.620.0017.006	Diagonal 7F	5
3.620.0017.007	Diagonal 8F	5
3.620.0017.008	Diagonal 9F	5
3.620.0017.009	Diagonal 10F	5
3.620.0017.010	Diagonal 11F	6
3.620.0017.011	Diagonal 12F	6
3.620.0017.012	Diagonal 13F	6
3.620.0020.001	Top Horizontal 2F	4
3.620.0020.002	Top Horizontal 3F	5
3.620.0020.003	Top Horizontal 4F	6
3.620.0020.004	Top Horizontal 5F	7
3.620.0020.005	Top Horizontal 6F	8

## 5' Foundation Section Components (continued)

Part Number	Description	Ship Wt. (lbs)
3.620.0020.006	Top Horizontal 7F	9
3.620.0020.007	Top Horizontal 8F	10
3.620.0020.008	Top Horizontal 9F	11
3.620.0020.009	Top Horizontal 10F	11
3.620.0020.010	Top Horizontal 11F	13
3.620.0020.011	Top Horizontal 12F & 12HDF	13
3.620.0020.012	Top Horizontal 13F	14
3.620.0020.013	Bottom Horizontal 2F	9
3.620.0020.014	Bottom Horizontal 3F	11
3.620.0020.015	Bottom Horizontal 4F	13
3.620.0020.016	Bottom Horizontal 5F	14
3.620.0020.017	Bottom Horizontal 6F	16
3.620.0020.018	Bottom Horizontal 7F	18
3.620.0020.019	Bottom Outer Horizontal 8F	19
3.620.0020.020	Bottom Outer Horizontal 9F	21
3.620.0020.021	Bottom Outer Horizontal 10F	23
3.620.0020.022	Bottom Outer Horizontal 11F	26
3.620.0020.023	Bottom Outer Horizontal 12F & 12HDF	63
3.620.0020.024	Bottom Outer Horizontal 13F	67
3.620.0020.025	Bottom Inner Horizontal 8F	19
3.620.0020.026	Bottom Inner Horizontal 9F	21
3.620.0020.027	Bottom Inner Horizontal 10F	23
3.620.0020.028	Bottom Inner Horizontal 11F	26
3.620.0020.029	Bottom Inner Horizontal 12F & 12HDF	63
3.620.0020.030	Bottom Inner Horizontal 13F & 13HDF	67

# Replacement Parts



Replacement Diagonals Braces		
Part Number	Description	Ship Wt. (lbs)
3.620.0016.001	# 1 (section # 1)	8
3.620.0016.002	# 2 (section # 1)	8
3.620.0016.003	# 3 (section # 1)	8
3.620.0016.004	# 4 (section # 1)	8
3.620.0016.005	# 5 (section # 1)	8
3.620.0016.006	# 6 (section # 2)	8
3.620.0016.007	# 7 (section # 2)	9
3.620.0016.008	# 8 (section # 2)	9
3.620.0016.009	# 9 (section # 2)	9
3.620.0016.010	#10 (section # 2)	9
3.620.0016.011	#11 (section # 3)	9
3.620.0016.012	#12 (section # 3)	9
3.620.0016.013	#13 (section # 3)	9
3.620.0016.014	#14 (section # 3)	10
3.620.0016.015	#15 (section # 3)	10
3.620.0016.016	#16 (section # 4)	10
3.620.0016.017	#17 (section # 4)	10
3.620.0016.018	#18 (section # 4)	10
3.620.0016.019	#19 (section # 4)	10
3.620.0016.020	#20 (section # 4)	10
3.620.0016.021	#21 (section # 5)	11
3.620.0016.022	#22 (section # 5)	11
3.620.0016.023	#23 (section # 5)	11
3.620.0016.024	#24 (section # 5)	11
3.620.0016.025	#25 (section # 5)	11
3.620.0016.026	#26 (section # 6)	11
3.620.0016.027	#27 (section # 6)	11
3.620.0016.028	#28 (section # 6)	11
3.620.0016.029	#29 (section # 6)	11
3.620.0016.030	#30 (section # 6)	11
3.620.0016.031	#31 (section # 7)	11
3.620.0016.032	#32 (section # 7)	12
3.620.0016.033	#33 (section # 7)	12
3.620.0016.034	#34 (section # 7)	12
3.620.0016.035	#35 (section # 7)	12
3.620.0016.036	#36 (section # 8)	12

Replacement Diagonals Braces		
Part Number	Description	Ship Wt. (lbs)
3.620.0016.037	#37 (section # 8)	12
3.620.0016.038	#38 (section # 8)	13
3.620.0016.039	#39 (section # 8)	13
3.620.0016.040	#40 (section # 8)	13
3.620.0016.041	#41 (section # 9)	13
3.620.0016.042	#42 (section # 9)	13
3.620.0016.043	#43 (section # 9)	13
3.620.0016.044	#44 (section # 9)	14
3.620.0016.045	#45 (section # 9)	14
3.620.0016.046	#46 (section #10)	14
3.620.0016.047	#47 (section #10)	14
3.620.0016.048	#48 (section #10)	14
3.620.0016.049	#49 (section #10)	14
3.620.0016.050	#50 (section #10)	14
3.620.0016.051	#51H (section #11)	14
3.620.0016.052	#52H (section #11)	14
3.620.0016.053	#53H (section #11)	14
3.620.0016.054	#54H (section #11)	14
3.620.0016.055	#55H (section #11)	14
3.620.0016.056	#56H (section #12)	15
3.620.0016.057	#57H (section #12)	15
3.620.0016.058	#58H (section #12)	15
3.620.0016.059	#59H (section #12)	15
3.620.0016.060	#60H (section #12)	15
3.620.0065.001	Bottom Right (section #21)	3
3.620.0065.002	Top Right (section #21)	3
3.620.0065.003	Bottom Right (section #20)	3
3.620.0065.004	Top Right (section #20)	3
3.620.0065.005	Bottom Right (section #19)	3
3.620.0065.006	Top Right (section #19)	3
3.620.0065.007	Bottom Right (section #18)	3
3.620.0065.008	Top Right (section #18)	3
3.620.0065.009	Bottom Right (section #17)	3
3.620.0065.010	Top Right (section #17)	3
3.620.0065.011	Bottom Right (section #16)	3
3.620.0065.012	Top Right (section #16)	3



Replacement Diagonals Braces		
Part Number	Description	Ship Wt. (lbs)
3.620.0065.013	Bottom Right (section #15)	3
3.620.0065.014	Top Right (section #15)	3
3.620.0065.015	Bottom Right (section #14)	3
3.620.0065.016	Top Right (section #14)	3
3.620.0065.017	Bottom Right (section #13)	3
3.620.0065.018	Top Right (section #13)	3
3.620.0065.019	X Brace (section #13)	3
3.620.0065.101	Bottom Left (section #21)	3
3.620.0065.102	Top Left (section #21)	3
3.620.0065.103	Bottom Left (section #20)	3
3.620.0065.104	Top Left (section #20)	3
3.620.0065.105	Bottom Left (section #19)	3
3.620.0065.106	Top Left (section #19)	3
3.620.0065.107	Bottom Left (section #18)	3
3.620.0065.108	Top Left (section #18)	3
3.620.0065.109	Bottom Left (section #17)	3
3.620.0065.110	Top Left (section #17)	3
3.620.0065.111	Bottom Left (section #16)	3
3.620.0065.112	Top Left (section #16)	3
3.620.0065.113	Bottom Left (section #15)	3
3.620.0065.114	Top Left (section #15)	3
3.620.0065.115	Bottom Left (section #14)	3
3.620.0065.116	Top Left (section #14)	3
3.620.0065.117	Bottom Left (section #13)	3
3.620.0065.118	Top Left (section #13)	3
3.620.0066.001	Horizontal (section #21)	3
3.620.0066.002	Horizontal (section #20)	3
3.620.0066.003	Horizontal (section #19)	3
3.620.0066.004	Horizontal (section #18)	3
3.620.0066.005	Horizontal (section #17)	3
3.620.0066.006	Horizontal (section #16)	3
3.620.0066.007	Horizontal (section #15)	3
3.620.0066.008	Horizontal (section #14)	3
3.620.0066.009	Horizontal (section #13)	3
3.620.0066.010	Top Horizontal (section #13)	3



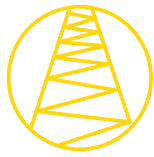

# SUPER TITAN™ KD Concrete Foundation Details

For towers with bottom sections # 2 to #12  
Including #11HD and #12HD  
(Normal dry soil)

Please email [info@trylon.com](mailto:info@trylon.com) for full foundation installation details, including foundation notes.

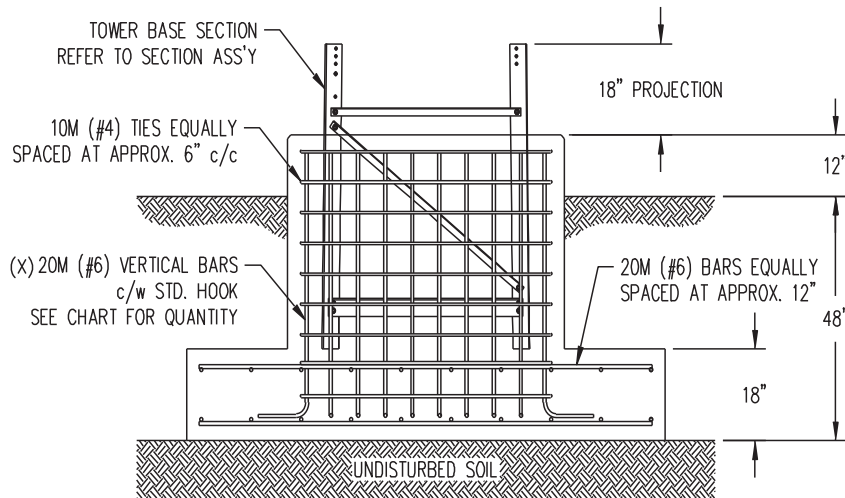
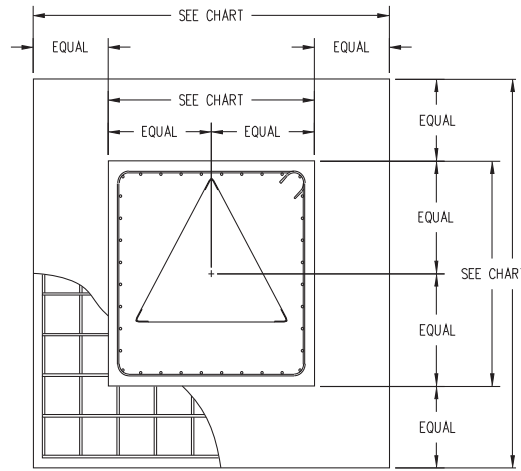

If Bottom Tower Section is:	Foundation Pad Size (ft.)	Pier Size (ft.)	Vertical Pier Bars (X)	Cubic Yards Concrete		
				Pad Concrete Volume	Pier Concrete Volume	Total Volume
#12	10'-6" x 10'-6"	5'-6" x 5'-6"	36	6.1	3.9	10.0
#11	10'-0" x 10'-0"	5'-6" x 5'-6"	36	5.6	3.9	9.5
#10	9'-6" x 9'-6"	5'-0" x 5'-0"	30	5.0	3.2	8.2
#9	9'-0" x 9'-0"	5'-0" x 5'-0"	30	4.5	3.2	7.7
#8	8'-6" x 8'-6"	4'-6" x 4'-6"	26	4.0	2.6	6.6
#7	7'-6" x 7'-6"	4'-6" x 4'-6"	26	3.1	2.6	5.7
#6	7'-0" x 7'-0"	4'-0" x 4'-0"	20	2.7	2.1	4.8
#5	6'-6" x 6'-6"	4'-0" x 4'-0"	20	2.4	2.1	4.5
#4	6'-6" x 6'-6"	4'-0" x 4'-0"	20	2.4	2.1	4.5
#3	6'-6" x 6'-6"	4'-0" x 4'-0"	20	2.4	2.1	4.5
#2	6'-0" x 6'-0"	4'-0" x 4'-0"	20	2.0	2.1	4.1

\* Includes Heavy Duty sections #11HD and #12HD.  
Notes: See [www.trylon.com](http://www.trylon.com) for important foundation and concrete notes.





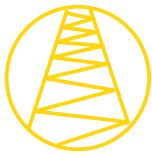

# Concrete Foundation Details

For towers with bottom sections #13 to #21  
Single-block, mat design  
(Normal dry soil)

Please email [info@trylon.com](mailto:info@trylon.com) for full foundation installation details, including foundation notes.

THIS FOUNDATION IS NOT SUITABLE IN AREAS WHERE GROUND FROST PENETRATION IS EXPECTED

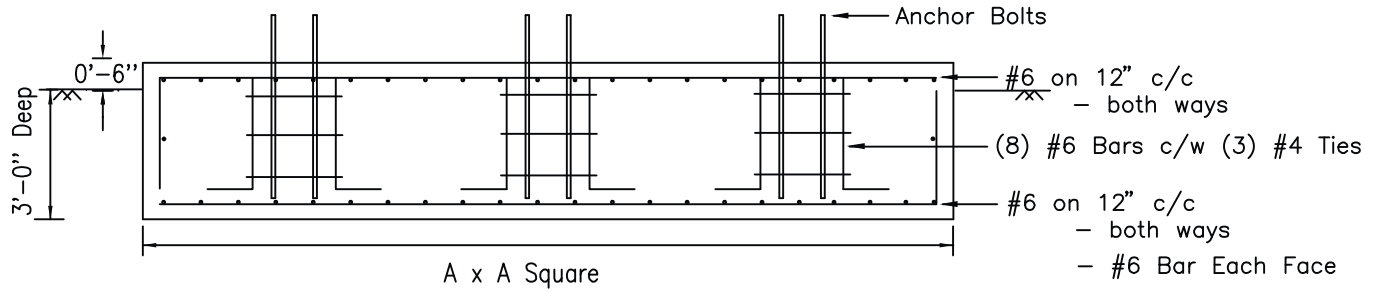

(0" Offset Tower Center to Foundation Center)

Base Section #	A (ft)	Concrete Vol
#13	12'-0"	18.7
#14	12'-6"	20.3
#15	13'-6"	23.6
#16	14'-0"	25.4
#17	14'-6"	27.3
#18	15'-0"	29.2
#19	16'-0"	33.2
#20	17'-0"	37.5
#21	18'-0"	42.0

#### NOTES:

Concrete volume in cubic yards.  
Theoretical concrete volumes given. Add 10% to that given when ordering the concrete.

#### FOUNDATION NOTES:

##### GENERAL:

- 1) ALL WORKMANSHIP AND MATERIALS SHALL BE IN ACCORDANCE WITH APPLICABLE LOCAL STANDARDS.
- 2) FOUNDATIONS DESIGNED FOR NORMAL DRY SOIL CONDITIONS.
- 3) THE TOWER BASE PAD SHALL BE PLACED AGAINST UNDISTURBED SOIL.

##### CONCRETE:

- 1) CONCRETE SHALL HAVE A MINIMUM COMPRESSIVE STRENGTH AT 28 DAYS OF NOT LESS THAN 4000 psi.
- 2) CONCRETE SHALL CONTAIN AN AIR ENTRAINING AGENT.
- 3) THE MAXIMUM SIZE OF COARSE AGGREGATE SHALL BE 3/4 in. SLUMP SHALL BE 3 in +/- 1 in
- 4) ALL GROUT SHALL BE NON-FERROUS AND NON SHRINK WITH A MINIMUM COMPRESSIVE STRENGTH OF 5000 psi AT 28 DAYS, EDGES GROUT SHALL BE TAPERED OFF AT 45°.

##### REINFORCEMENT:

- 1) ALL REINFORCEMENT SHALL HAVE A MINIMUM OF 3 in CONCRETE COVER.
- 2) REINFORCING STEEL SHALL BE DEFORMED BARS WITH A MINIMUM YIELD OF 60 ksi.





$\frac{EL. = 251.00'}{h-h = 2.50'}$   
 $\frac{EL. = 241.00'}{h-h = 2.76'}$   
 $\frac{EL. = 222.00'}{h-h = 3.25'}$   
 $\frac{EL. = 203.00'}{h-h = 3.75'}$   
 $\frac{EL. = 190.00'}{h-h = 4.00'}$   
 $\frac{EL. = 171.00'}{h-h = 6.00'}$   
 $\frac{EL. = 152.00'}{h-h = 8.00'}$   
 $\frac{EL. = 133.00'}{h-h = 10.00'}$   
 $\frac{EL. = 114.00'}{h-h = 12.00'}$   
 $\frac{EL. = 95.00'}{h-h = 14.00'}$   
 $\frac{EL. = 76.00'}{h-h = 16.00'}$   
 $\frac{EL. = 57.00'}{h-h = 18.00'}$   
 $\frac{EL. = 38.00'}{h-h = 20.00'}$   
 $\frac{EL. = 19.00'}{h-h = 22.00'}$   
 $\frac{EL. = 0'}{h-h = 24.00'}$

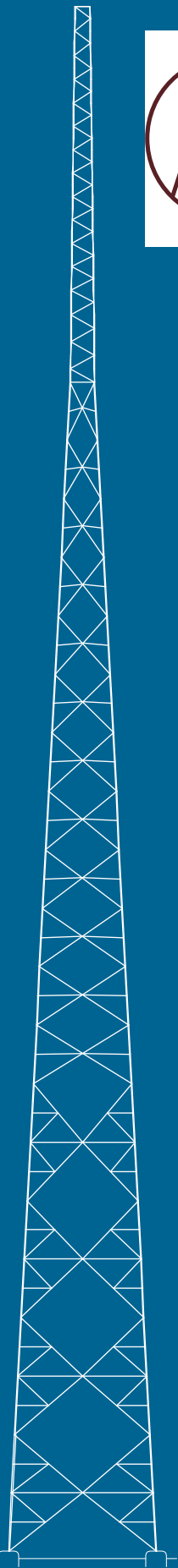

# SUPER TITAN<sup>TM</sup> MAX

- .. TIA/EIA 222 F and G Compliant
- .. Ships directly from Tylon
- .. Ships knocked-down (unassembled) in 19' sections
- .. Max face width: 24 feet
- .. P.E drawings available

Trylon introduces a **new** member to the Stocked Product family and his name is MAX...

## SuperTitan MAX

Total Height: 96'  
Total Load: 15 sq ft\*



(\*70 mph Survival Wind Speed & 0" ice)

Total Height: 190'  
Total Load: 10 sq ft\*

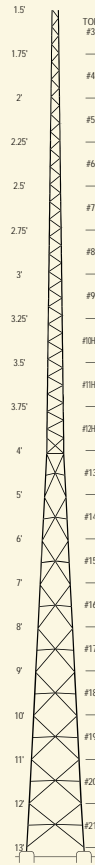

(\*350 Pa CSA S37-01 & 25 mm ice)

**MAX Height: 251'**  
**MAX Load: 92 sq ft\***

EL. = 251.00'  
h-h = 2.50'

EL. = 241.00'  
h-h = 2.76'

EL. = 222.00'  
h-h = 3.25'

EL. = 203.00'  
h-h = 3.75'

EL. = 190.00'  
h-h = 4.00'

EL. = 171.00'  
h-h = 6.00'

EL. = 152.00'  
h-h = 8.00'

EL. = 133.00'  
h-h = 10.00'

EL. = 114.00'  
h-h = 12.00'

EL. = 95.00'  
h-h = 14.00'

EL. = 76.00'  
h-h = 16.00'

EL. = 57.00'  
h-h = 18.00'

EL. = 38.00'  
h-h = 20.00'

EL. = 19.00'  
h-h = 22.00'

EL. = 0'  
h-h = 24.00'

(\*350 Pa CSA S37-01 & 25 mm ice)



- Survival tower
- Stocked and sold through distribution
- Ship assembled in 8' sections
- Max face width: 45 inches
- P.E. stamp **not** available
- Model shown: 96' T200

- TIA/EIA 222 F and G compliant
- Stocked and sold through distribution
- Ship knocked-down (unassembled) in 10' sections
- Max face width: 13 feet
- P.E. stamp available
- Model shown: 190' S310

- TIA/EIA 222 F and G compliant
- Ships directly from Trylon
- Ship knocked-down (unassembled) in 19' sections
- Max face width: 24 feet
- P.E. stamp available
- Model shown: 251' M300

# Tower Profile

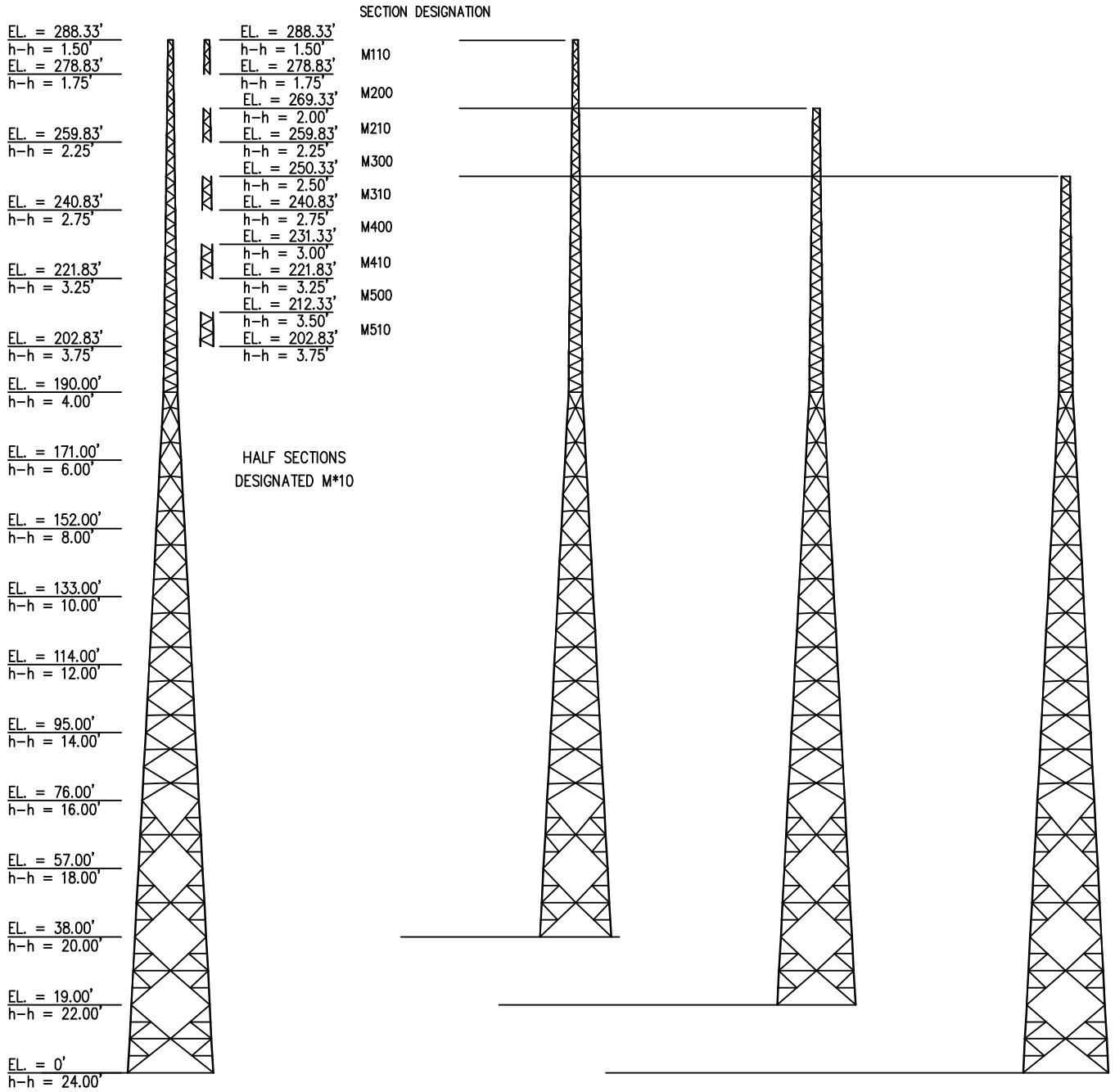

COMPLETE TOWER

COMPLETE SECTIONS  
DESIGNATED M\*00



251-ft M110 - 24 ft<sup>2</sup>  
350 Pa, 25mm Ice  
CSA S37-01

251-ft M210 - 54 ft<sup>2</sup>  
350 Pa, 25mm Ice  
CSA S37-01

251-ft M310 - 92 ft<sup>2</sup>  
350 Pa, 25mm Ice  
CSA S37-01



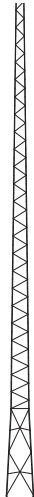
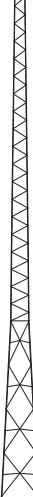

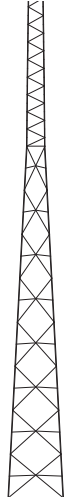
Model Designation:	M210	M310	M410	M510			
Part Number:	5.630.0210.099	5.630.0310.099	5.630.0410.099	5.630.0510.099			
Includes anchor material for concrete foundation and splice hardware.	 #2 #3 #4 #5 #6 #7	 #3 #4 #5 #6 #7 #8	 #4 #5 #6 #7 #8 #9	 #5 #6 #7 #8 #9 #10			
Shipping Dimensions (L"xW"xH")	2 Bundles: 19'X10"x6" 2 Bundles: 19'x12"x8" 3 Bundles: 19'x15"x8" 1 Crate : 62"x20"x15"	2 Bundles: 19'X10"x6" 2 Bundles: 19'x12"x8" 3 Bundles: 19'x15"x8" 1 Crate : 62"x20"x15"	2 Bundles: 19'X10"x6" 2 Bundles: 19'x12"x8" 3 Bundles: 19'x15"x8" 1 Crate : 62"x20"x15"	2 Bundles: 19'X10"x6" 2 Bundles: 19'x12"x8" 3 Bundles: 19'x15"x8" 1 Crate : 62"x20"x15"			
Shipping Weight (lbs)	4,600	7,900	9,000	10,040			

\*Assumptions: Projected areas (PA) shown are bare; a 1.5 multiplier used for iced area; loads centrally located and balanced at tower top; considers step-pegs, safety cable, and one 1/2" tx line per 10 sq.ft.; "-" indicates tower failure.  
 \*Round antennas include omnis, dipoles, dishes with radomes, etc. Antennas where wind hits a round surface. Flat Antennas include flat panels, dishes without radomes and cameras, where wind hits a flat surface.  
 \*Please contact Trylon directly for more information.

## Common Accessories

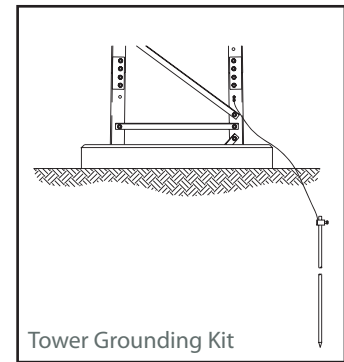

Accessory:	M210	M310	M410	M510		
<b>Cable Safety Climb Kits</b> <i>no slider</i>	4.99.0495.100	4.99.0495.100	4.99.0495.100	4.99.0495.100		
<b>Step-Bolt Kit</b> <i>leg mounted</i>	4.630.S210.099	4.630.S310.099	4.630.S410.099	4.630.S510.099		
<b>Anti-Climb Shield Kits</b>	4.630.0001.213	4.630.0001.213	4.630.0001.213	4.630.0001.213		
<b>Tower Grounding Kit</b> <i>basic, three leg</i>	4.91.0103.003	4.91.0103.003	4.91.0103.003	4.91.0103.003		

# 108' Towers



Model Designation:	M200	M300	M400	M500	M600		
Part Number:	5.630.0219.108	5.630.0319.108	5.630.0419.108	5.630.0519.108	5.630.0619.108		
Includes anchor material for concrete foundation and splice hardware.							
Shipping Dimensions (L"xW"xH")	2 Bundles: 19"x10"x8" 2 Bundles: 19"x12"x8" 3 Bundles: 19"x15"x8" 1 Crate : 62"x20"x15"	2 Bundles: 19"x10"x8" 2 Bundles: 19"x12"x8" 3 Bundles: 19"x15"x8" 1 Crate : 62"x20"x15"	2 Bundles: 19"x10"x8" 2 Bundles: 19"x12"x8" 3 Bundles: 19"x15"x8" 1 Crate : 62"x20"x15"	2 Bundles: 19"x10"x8" 2 Bundles: 19"x12"x8" 3 Bundles: 19"x15"x8" 1 Crate : 62"x20"x15"	2 Bundles: 19"x10"x8" 2 Bundles: 19"x12"x8" 3 Bundles: 19"x15"x8" 1 Crate : 62"x20"x15"		
Shipping Weight (lbs)	5725	6755	7776	8730	9720		



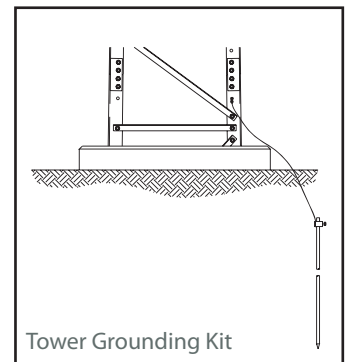

\*Assumptions: Projected areas (PA) shown are bare; a 1.5 multiplier used for iced area; loads centrally located and balanced at tower top; considers step-pegs, safety cable, and one 1/2" tx line per 10 sq.ft.; "--" indicates tower failure.  
 \*Round antennas include omnis, dipoles, dishes with radomes, etc. Antennas where wind hits a round surface. Flat Antennas include flat panels, dishes without radomes and cameras, where wind hits a flat surface.  
 \*Please contact Trylon directly for more information.

## Common Accessories

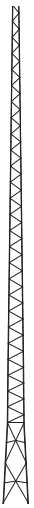

Accessory:	M200	M300	M400	M500	M600		
<b>Cable Safety Climb Kits</b> <i>no slider</i>	4.99.0495.150	4.99.0495.150	4.99.0495.150	4.99.0495.150	4.99.0495.150		
<b>Step-Bolt Kit</b> <i>leg mounted</i>	4.630.S200.108	4.630.S300.108	4.630.S400.108	4.630.S500.108	4.630.S600.108		
<b>Anti-Climb Shield Kits</b>	4.630.0001.213	4.630.0001.213	4.630.0001.213	4.630.0001.213	4.630.0001.213		
<b>Tower Grounding Kit</b> <i>basic, three leg</i>	4.91.0103.003	4.91.0103.003	4.91.0103.003	4.91.0103.003	4.91.0103.003		

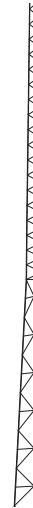

Model Designation:		M110	M210	M310	M410	M510		
Part Number:		5.630.0110.118	5.630.0210.118	5.630.0310.118	5.630.0410.118	5.630.0510.118		
Includes anchor material for concrete foundation and splice hardware.								
		#1 #2 #3 #4 #5 #6 #7	#2 #3 #4 #5 #6 #7 #8	#3 #4 #5 #6 #7 #8 #9	#4 #5 #6 #7 #8 #9 #10	#5 #6 #7 #8 #9 #10 #11		
Allowable antenna area in ft**	EIA Rev.G Class 1 90/105/120 mph wind 3/4" ice	Round: 34/12/-- Flat: 23/8/--	Round: 74/36/12 Flat: 49/24/8	Round: 126/64/30 Flat: 84/43/120	Round: 136/84/36 Flat: 91/56/24	Round: 262/158/72 Flat: 175/105/48		
	EIA Rev.G Class 2 90/105/120 mph wind 3/4" ice	Round: 26/4/-- Flat: 17/3/--	Round: 58/26/2 Flat: 39/17/1	Round: 102/50/14 Flat: 68/33/9	Round: 116/64/18 Flat: 77/43/12	Round: 224/118/48 Flat: 149/79/32		
Shipping Dimensions (L"xW"xH")		2 Bundles: 19'X10"x6" 2 Bundles: 19'x12"x8" 3 Bundles: 19'x15"x8" 1 Crate : 62"x20"x15"	2 Bundles: 19'X10"x6" 2 Bundles: 19'x12"x8" 3 Bundles: 19'x15"x8" 1 Crate : 62"x20"x15"	2 Bundles: 19'X10"x6" 2 Bundles: 19'x12"x8" 3 Bundles: 19'x15"x8" 1 Crate : 62"x20"x15"	2 Bundles: 19'X10"x6" 2 Bundles: 19'x12"x8" 3 Bundles: 19'x15"x8" 1 Crate : 62"x20"x15"	2 Bundles: 19'X10"x6" 2 Bundles: 19'x12"x8" 3 Bundles: 19'x15"x8" 1 Crate : 62"x20"x15"		
Shipping Weight (lbs)		5800	6900	7900	9000	10040		

\*Assumptions: Projected areas (PA) shown are bare; a 1.5 multiplier used for iced area; loads centrally located and balanced at tower top; considers step-pegs, safety cable, and one 1/2" tx line per 10 sq.ft.; "--" indicates tower failure.  
 \*\*Round antennas include omnis, dipoles, dishes with radomes, etc. Antennas where wind hits a round surface. Flat Antennas include flat panels, dishes without radomes and cameras, where wind hits a flat surface.  
 \*Please contact Trylon directly for more information.

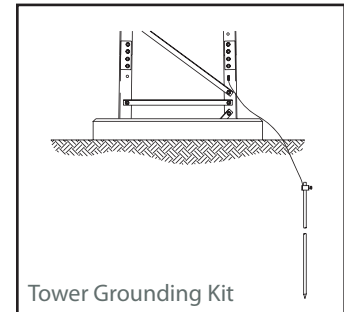

## Common Accessories



Accessory:	M110	M210	M310	M410	M510		
<b>Cable Safety Climb Kits</b> <i>no slider</i>	4.99.0495.150	4.99.0495.150	4.99.0495.150	4.99.0495.150	4.99.0495.150		
<b>Step-Bolt Kit</b> <i>leg mounted</i>	4.630.S110.118	4.630.S210.118	4.630.S310.118	4.630.S410.118	4.630.S510.118		
<b>Anti-Climb Shield Kits</b>	4.630.0001.213	4.630.0001.213	4.630.0001.213	4.630.0001.213	4.630.0001.213		
<b>Tower Grounding Kit</b> <i>basic, three leg</i>	4.91.0103.003	4.91.0103.003	4.91.0103.003	4.91.0103.003	4.91.0103.003		

# 127' Towers

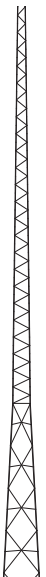
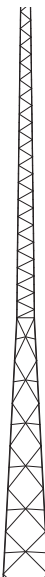

Model Designation:		M200	M300	M400	M500			
Part Number:		5.630.0219.127	5.630.0319.127	5.630.0419.127	5.630.0519.127			
Includes anchor material for concrete foundation and splice hardware.								
		#2	#3	#4	#5			
		#3	#4	#5	#6			
		#4	#5	#6	#7			
		#5	#6	#7	#8			
		#6	#7	#8	#9			
		#7	#8	#9	#10			
		#8	#9	#10	#11			
Allowable antenna area in ft <sup>2</sup> *	EIA Rev.G Class 1 90/105/120 mph wind 3/4" ice	Round: 48/22/- Flat: 32/15/-	Round: 106/50/14 Flat: 71/33/9	Round: 128/66/20 Flat: 85/44/13	Round: 248/118/46 Flat: 165/79/31			
	EIA Rev.G Class 2 90/105/120 mph wind 3/4" ice	Round: 38/14/- Flat: 25/9/-	Round: 82/34/- Flat: 55/23/-	Round: 106/46/4 Flat: 71/31/3	Round: 196/82/30 Flat: 131/55/20			
Shipping Dimensions (L"xW"xH")		2 Bundles: 19"x10"x6" 2 Bundles: 19"x12"x8" 3 Bundles: 19"x15"x8" 1 Crate : 62"x20"x15"	2 Bundles: 19"x10"x6" 2 Bundles: 19"x12"x8" 3 Bundles: 19"x15"x8" 1 Crate : 62"x20"x15"	2 Bundles: 19"x10"x6" 2 Bundles: 19"x12"x8" 3 Bundles: 19"x15"x8" 1 Crate : 62"x20"x15"	2 Bundles: 19"x10"x6" 2 Bundles: 19"x12"x8" 3 Bundles: 19"x15"x8" 1 Crate : 62"x20"x15"			
Shipping Weight (lbs)		7100	8200	9300	10700			

\*Assumptions: Projected areas (PA) shown are bare; a 1.5 multiplier used for iced area; loads centrally located and balanced at tower top; considers step-pegs, safety cable, and one 1/2" tx line per 10 sq.ft.; "-" indicates tower failure.  
 \*Round antennas include omnis, dipoles, dishes with radomes, etc. Antennas where wind hits a round surface. Flat Antennas include flat panels, dishes without radomes and cameras, where wind hits a flat surface.  
 \*Please contact Tylon directly for more information.

## Common Accessories

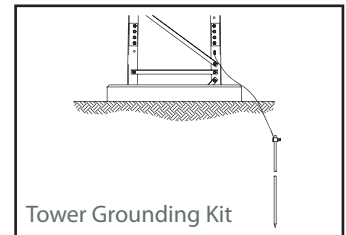

Accessory:	M200	M300	M400	M500			
<b>Cable Safety Climb Kits</b> <i>no slider</i>	4.99.0495.150	4.99.0495.150	4.99.0495.150	4.99.0495.150			
<b>Step-Bolt Kit</b> <i>leg mounted</i>	4.630.S200.127	4.630.S300.127	4.630.S400.127	4.630.S500.127			
<b>Anti-Climb Shield Kits</b>	4.630.0001.213	4.630.0001.213	4.630.0001.213	4.630.0001.213			
<b>Tower Grounding Kit</b> <i>basic, three leg</i>	4.91.0103.003	4.91.0103.003	4.91.0103.003	4.91.0103.003			



Model Designation:		M110	M210	M310	M410	M510		
Part Number:		5.630.0110.137	5.630.0210.137	5.630.0310.137	5.630.0410.137	5.630.0510.137		
Includes anchor material for concrete foundation and splice hardware.								
Allowable antenna area in ft <sup>2</sup> *	EIA Rev.G Class 1 90/105/120 mph wind 3/4" ice	Round: 30/10/-- Flat: 20/7/--	Round: 70/32/4 Flat: 47/21/3	Round: 120/48/8 Flat: 80/32/5	Round: 132/82/30 Flat: 88/55/20	Round: 252/146/52 Flat: 168/97/35		
	EIA Rev.G Class 2 90/105/120 mph wind 3/4" ice	Round: 22/2/-- Flat: 15/1/--	Round: 54/22/-- Flat: 36/15/--	Round: 96/30/-- Flat: 64/20/--	Round: 112/54/14 Flat: 75/36/9	Round: 216/106/30 Flat: 144/71/20		
Shipping Dimensions (L"xW"xH")		2 Bundles: 19'X10"x6" 2 Bundles: 19'x12"x8" 3 Bundles: 19'x15"x8" 1 Crate: 76"x25"x15"	2 Bundles: 19'X10"x6" 2 Bundles: 19'x12"x8" 3 Bundles: 19'x15"x8" 1 Crate: 76"x25"x15"	2 Bundles: 19'X10"x6" 2 Bundles: 19'x12"x8" 3 Bundles: 19'x15"x8" 1 Crate: 76"x25"x15"	2 Bundles: 19'X10"x6" 2 Bundles: 19'x12"x8" 3 Bundles: 19'x15"x8" 1 Crate: 76"x25"x15"	2 Bundles: 19'X10"x6" 2 Bundles: 19'x12"x8" 3 Bundles: 19'x15"x8" 1 Crate: 76"x25"x15"		
Shipping Weight (lbs)		7200	8300	9400	10900	12600		

\*Assumptions: Projected areas (PA) shown are bare; a 1.5 multiplier used for iced area; loads centrally located and balanced at tower top; considers step-pegs, safety cable, and one 1/2" tx line per 10 sq.ft.; "--" indicates tower failure.  
 \*Round antennas include omnis, dipoles, dishes with radomes, etc. Antennas where wind hits a round surface. Flat Antennas include flat panels, dishes without radomes and cameras, where wind hits a flat surface.  
 \*Please contact Trylon directly for more information.  
 \*Please contact Trylon directly for more information.

## Common Accessories

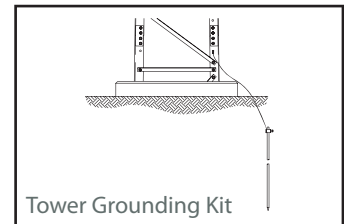
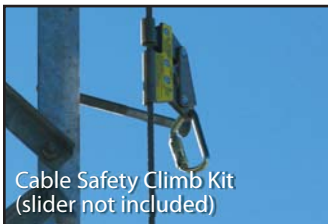

Accessory:	M110	M210	M310	M410	M510		
<b>Cable Safety Climb Kits</b> <i>no slider</i>	4.99.0495.150	4.99.0495.150	4.99.0495.150	4.99.0495.150	4.99.0495.150		
<b>Step-Bolt Kit</b> <i>leg mounted</i>	4.630.S110.137	4.630.S210.137	4.630.S310.137	4.630.S410.137	4.630.S510.137		
<b>Anti-Climb Shield Kits</b>	4.630.0001.213	4.630.0001.213	4.630.0001.213	4.630.0001.213	4.630.0001.213		
<b>Tower Grounding Kit</b> <i>basic, three leg</i>	4.91.0103.003	4.91.0103.003	4.91.0103.003	4.91.0103.003	4.91.0103.003		



# 146' Towers

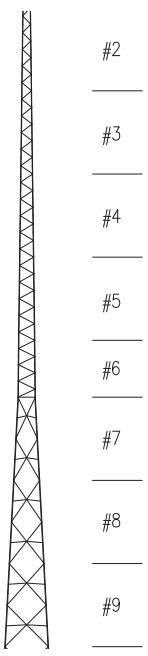
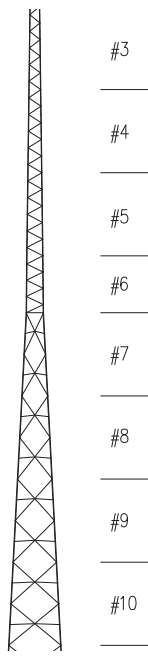
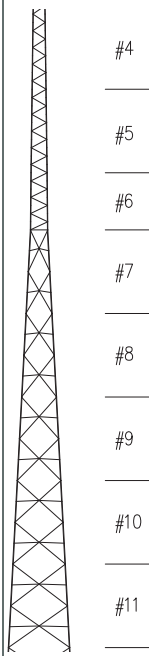
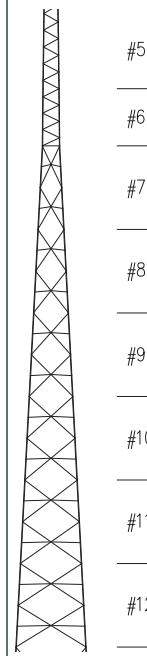
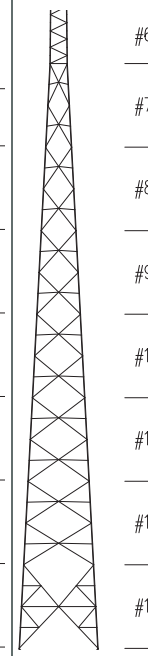

Model Designation:		M200	M300	M400	M500	M600		
Part Number:		5.630.0219.146	5.630.0319.146	5.630.0419.146	5.630.0519.146	5.630.0619.146		
Includes anchor material for concrete foundation and splice hardware.								
		#2 #3 #4 #5 #6 #7 #8 #9	#3 #4 #5 #6 #7 #8 #9 #10	#4 #5 #6 #7 #8 #9 #10 #11	#5 #6 #7 #8 #9 #10 #11 #12	#6 #7 #8 #9 #10 #11 #12 #13		
Allowable antenna area in ft <sup>2</sup> *	EIA Rev.G Class 1 90/105/120 mph wind 3/4" ice	Round: 46/18/-- Flat: 31/12/--	Round: 100/34/14 Flat: 67/23/--	Round: 122/56/14 Flat: 81/37/9	Round: 234/108/34 Flat: 156/72/23	Round: 244/138/14 Flat: 163/92/9		
	EIA Rev.G Class 2 90/105/120 mph wind 3/4" ice	Round: 36/10/-- Flat: 24/7/--	Round: 78/16/-- Flat: 52/11/--	Round: 102/40/-- Flat: 68/27/--	Round: 184/74/14 Flat: 123/49/9	Round: 202/110/28 Flat: 135/73/19		
Shipping Dimensions (L"xW"xH")		2 Bundles: 19"x10"x8" 2 Bundles: 19"x12"x8" 4 Bundles: 19"x15"x8" 1 Crate: 76"x25"x15"	2 Bundles: 19"x10"x8" 2 Bundles: 19"x12"x8" 4 Bundles: 19"x15"x8" 1 Crate: 76"x25"x15"	2 Bundles: 19"x10"x8" 2 Bundles: 19"x12"x8" 4 Bundles: 19"x15"x8" 1 Crate: 76"x25"x15"	2 Bundles: 19"x10"x8" 2 Bundles: 19"x12"x8" 4 Bundles: 19"x15"x8" 1 Crate: 76"x25"x15"	2 Bundles: 19"x10"x8" 2 Bundles: 19"x12"x8" 4 Bundles: 19"x15"x8" 1 Crate: 76"x25"x15"		
Shipping Weight (lbs)		8400	9600	11200	12800			

\*Assumptions: Projected areas (PA) shown are bare; a 1.5 multiplier used for iced area; loads centrally located and balanced at tower top; considers step-pegs, safety cable, and one 1/2" tx line per 10 sq.ft.; "--" indicates tower failure.  
 \*Round antennas include omnis, dipoles, dishes with radomes, etc. Antennas where wind hits a round surface. Flat Antennas include flat panels, dishes without radomes and cameras, where wind hits a flat surface.  
 \*Please contact Tylon directly for more information.

## Common Accessories



Accessory:	M200	M300	M400	M500	M600		
<b>Cable Safety Climb Kits</b> <i>no slider</i>	4.99.0495.150	4.99.0495.150	4.99.0495.150	4.99.0495.150	4.99.0495.150		
<b>Step-Bolt Kit</b> <i>leg mounted</i>	4.630.S200.146	4.630.S300.146	4.630.S400.146	4.630.S500.146	4.630.S600.146		
<b>Anti-Climb Shield Kits</b>	4.630.0001.213	4.630.0001.213	4.630.0001.213	4.630.0001.213	4.630.0001.213		
<b>Tower Grounding Kit</b> <i>basic, three leg</i>	4.91.0103.003	4.91.0103.003	4.91.0103.003	4.91.0103.003	4.91.0103.003		



Model Designation:		M110	M210	M310	M410	M510		
Part Number:		5.630.0110.156	5.630.0210.156	5.630.0310.156	5.630.0410.156	5.630.0510.156		
Includes anchor material for concrete foundation and splice hardware.								
Allowable antenna area in ft <sup>2</sup> *	EIA Rev.G Class 1 90/105/120 mph wind 3/4" ice	Round: 30/8/-- Flat: 20/5/--	Round: 66/22/-- Flat: 44/16/--	Round: 116/46/2 Flat: 77/31/1	Round: 128/76/20 Flat: 85/51/13	Round: 244/136/14 Flat: 163/91/9		
	EIA Rev.G Class 2 90/105/120 mph wind 3/4" ice	Round: 20/--/-- Flat: 13/--/--	Round: 52/8/-- Flat: 35/5/--	Round: 92/26/-- Flat: 61/17/--	Round: 108/50/-- Flat: 72/33/--	Round: 210/92/-- Flat: 140/61/--		
Shipping Dimensions (L"xW"xH")		2 Bundles: 19'x10"x8" 2 Bundles: 19'x12"x8" 4 Bundles: 19'x15"x8" 1 Crate: 76"x25"x15"	2 Bundles: 19'x10"x8" 2 Bundles: 19'x12"x8" 4 Bundles: 19'x15"x8" 1 Crate: 76"x25"x15"	2 Bundles: 19'x10"x8" 2 Bundles: 19'x12"x8" 4 Bundles: 19'x15"x8" 1 Crate: 76"x25"x15"	2 Bundles: 19'x10"x8" 2 Bundles: 19'x12"x8" 4 Bundles: 19'x15"x8" 1 Crate: 76"x25"x15"	2 Bundles: 19'x10"x8" 2 Bundles: 19'x12"x8" 4 Bundles: 19'x15"x8" 1 Crate: 76"x25"x15"		
Shipping Weight (lbs)		8500	9800	11400	13200	15200		

\*Assumptions: Projected areas (PA) shown are bare; a 1.5 multiplier used for iced area; loads centrally located and balanced at tower top; considers step-pegs, safety cable, and one 1/2" tx line per 10 sq.ft.; "--" indicates tower failure.  
 \*Round antennas include omnis, dipoles, dishes with radomes, etc. Antennas where wind hits a round surface. Flat Antennas include flat panels, dishes without radomes and cameras, where wind hits a flat surface.  
 \*Please contact Tylon directly for more information.

## Common Accessories

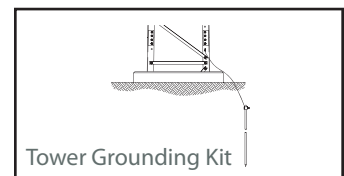
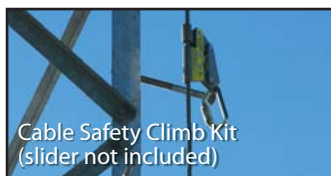

Accessory:	M110	M210	M310	M410	M510		
<b>Cable Safety Climb Kits</b> <i>no slider</i>	4.99.0495.200	4.99.0495.200	4.99.0495.200	4.99.0495.200	4.99.0495.200		
<b>Step-Bolt Kit</b> <i>leg mounted</i>	4.630.S110.156	4.630.S210.156	4.630.S310.156	4.630.S410.156	4.630.S510.156		
<b>Anti-Climb Shield Kits</b>	4.630.0001.213	4.630.0001.213	4.630.0001.213	4.630.0001.213	4.630.0001.213		
<b>Tower Grounding Kit</b> <i>basic, three leg</i>	4.91.0103.003	4.91.0103.003	4.91.0103.003	4.91.0103.003	4.91.0103.003		

# 165' Towers



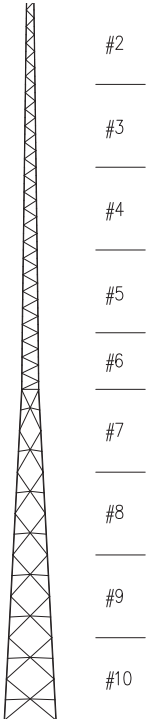
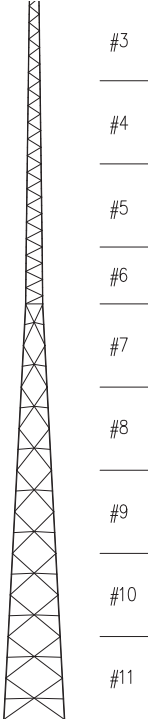
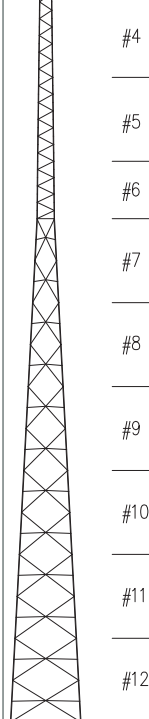
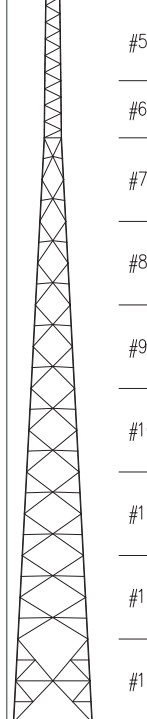
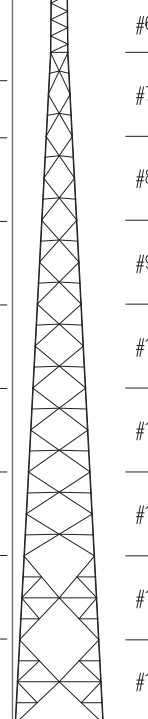

Model Designation:		M200	M300	M400	M500	M600		
Part Number:		5.630.0219.165	5.630.0319.165	5.630.0419.165	5.630.0519.165	5.630.0619.165		
Includes anchor material for concrete foundation and splice hardware.								
		#2	#3	#4	#5	#6		
		#3	#4	#5	#6	#7		
		#4	#5	#6	#7	#8		
		#5	#6	#7	#8	#9		
		#6	#7	#8	#9	#10		
		#7	#8	#9	#10	#11		
		#8	#9	#10	#11	#12		
		#9	#10	#11	#12	#13		
		#10	#11	#12	#13	#14		
Allowable antenna area in ft <sup>2</sup> *	EIA Rev.G Class 1 90/105/120 mph wind 3/4" ice	Round: 46/14/- Flat: 31/9/-	Round: 94/30/- Flat: 63/20/-	Round: 118/52/8 Flat: 79/35/5	Round: 224/98/12 Flat: 149/65/8	Round: 252/142/16 Flat: 168/95/11		
	EIA Rev.G Class 2 90/105/120 mph wind 3/4" ice	Round: 34/-/- Flat: 23/-/-	Round: 68/14/- Flat: 45/9/-	Round: 98/32/- Flat: 65/2/-	Round: 174/62/- Flat: 116/41/-	Round: 212/72/- Flat: 141/48/-		
Shipping Dimensions (L"xW"xH")		2 Bundles: 19"x10"x8" 2 Bundles: 19"x12"x8" 5 Bundles: 19"x15"x8" 1 Crate: 76"x25"x15"	2 Bundles: 19"x10"x8" 2 Bundles: 19"x12"x8" 5 Bundles: 19"x15"x8" 1 Crate: 76"x25"x15"	2 Bundles: 19"x10"x8" 2 Bundles: 19"x12"x8" 5 Bundles: 19"x15"x8" 1 Crate: 76"x25"x15"	2 Bundles: 19"x10"x8" 2 Bundles: 19"x12"x8" 5 Bundles: 19"x15"x8" 1 Crate: 76"x25"x15"	3 Bundles: 19"x10"x8" 3 Bundles: 19"x12"x8" 6 Bundles: 19"x15"x8" 2 Crate: 76"x25"x15"		
Shipping Weight (lbs)		10000	11600	13400	15500			

\*Assumptions: Projected areas (PA) shown are bare; a 1.5 multiplier used for iced area; loads centrally located and balanced at tower top; considers step-pegs, safety cable, and one 1/2" tx line per 10 sq.ft.; "-" indicates tower failure.  
 \*Round antennas include omnis, dipoles, dishes with radomes, etc. Antennas where wind hits a round surface. Flat Antennas include flat panels, dishes without radomes and cameras, where wind hits a flat surface.  
 \*Please contact Tylon directly for more information.

## Common Accessories

Accessory:	M200	M300	M400	M500	M600		
<b>Cable Safety Climb Kits</b> <i>no slider</i>	4.99.0495.200	4.99.0495.200	4.99.0495.200	4.99.0495.200	4.99.0495.200		
<b>Step-Bolt Kit</b> <i>leg mounted</i>	4.630.S200.165	4.630.S300.165	4.630.S400.165	4.630.S500.165	4.630.S600.165		
<b>Anti-Climb Shield Kits</b>	4.630.0001.213	4.630.0001.213	4.630.0001.213	4.630.0001.213	4.630.0001.213		
<b>Tower Grounding Kit</b> <i>basic, three leg</i>	4.91.0103.003	4.91.0103.003	4.91.0103.003	4.91.0103.003	4.91.0103.003		

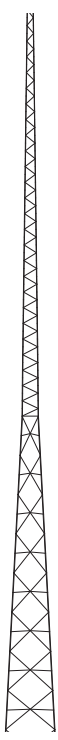
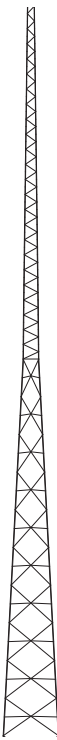
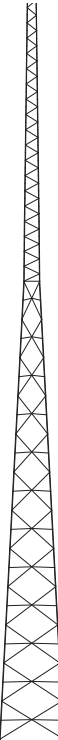

Model Designation:		M110	M210	M310	M410	M510		
Part Number:		5.630.0110.175	5.630.0210.175	5.630.0310.175	5.630.0410.175	5.630.0510.175		
Includes anchor material for concrete foundation and splice hardware.								
		#1 #2 #3 #4 #5 #6 #7 #8 #9 #10	#2 #3 #4 #5 #6 #7 #8 #9 #10 #11	#3 #4 #5 #6 #7 #8 #9 #10 #11 #12	#4 #5 #6 #7 #8 #9 #10 #11 #12 #13	#5 #6 #7 #8 #9 #10 #11 #12 #13 #14		
Allowable antenna area in ft <sup>2</sup> *	EIA Rev.G Class 1 90/105/120 mph wind 3/4" ice	Round: 28/4/-- Flat: 19/3/--	Round: 64/16/-- Flat: 43/11/--	Round: 112/38/-- Flat: 75/25/--	Round: 124/68/-- Flat: 83/45/--	Round: 238/126/-- Flat: 159/84/--		
	EIA Rev.G Class 2 90/105/120 mph wind 3/4" ice	Round: 18/--/-- Flat: 12/--/--	Round: 52/2/-- Flat: 35/1/--	Round: 84/20/-- Flat: 56/13/--	Round: 106/46/-- Flat: 71/31/--	Round: 204/56/-- Flat: 136/37/--		
Shipping Dimensions (L"xW"xH")		2 Bundles: 19'x10"x8" 2 Bundles: 19'x12"x8" 5 Bundles: 19'x15"x8" 1 Crate: 76"x25"x15"	2 Bundles: 19'x10"x8" 2 Bundles: 19'x12"x8" 5 Bundles: 19'x15"x8" 1 Crate: 76"x25"x15"	2 Bundles: 19'x10"x8" 2 Bundles: 19'x12"x8" 5 Bundles: 19'x15"x8" 1 Crate: 76"x25"x15"	2 Bundles: 19'x10"x8" 2 Bundles: 19'x12"x8" 5 Bundles: 19'x15"x8" 1 Crate: 76"x25"x15"	2 Bundles: 19'x10"x8" 2 Bundles: 19'x12"x8" 5 Bundles: 19'x15"x8" 1 Crate: 76"x25"x15"		
Shipping Weight (lbs)		10500	11700	13600	15900	17800		



\*Assumptions: Projected areas (PA) shown are bare; a 1.5 multiplier used for iced area; loads centrally located and balanced at tower top; considers step-pegs, safety cable, and one 1/2" tx line per 10 sq.ft.; "--" indicates tower failure.  
 \*Round antennas include omnis, dipoles, dishes with radomes, etc. Antennas where wind hits a round surface. Flat Antennas include flat panels, dishes without radomes and cameras, where wind hits a flat surface.  
 \*Please contact Trylon directly for more information.

## Common Accessories

Accessory:	M110	M210	M310	M410	M510		
<b>Cable Safety Climb Kits</b> <i>no slider</i>	4.99.0495.200	4.99.0495.200	4.99.0495.200	4.99.0495.200	4.99.0495.200		
<b>Step-Bolt Kit</b> <i>leg mounted</i>	4.630.S110.175	4.630.S210.175	4.630.S310.175	4.630.S410.175	4.630.S510.175		
<b>Anti-Climb Shield Kits</b>	4.630.0001.213	4.630.0001.213	4.630.0001.213	4.630.0001.213	4.630.0001.213		
<b>Tower Grounding Kit</b> <i>basic, three leg</i>	4.91.0103.003	4.91.0103.003	4.91.0103.003	4.91.0103.003	4.91.0103.003		

# 184' Towers

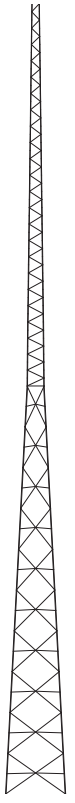
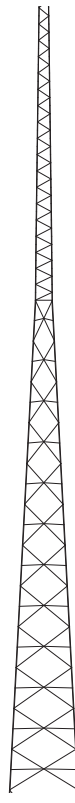
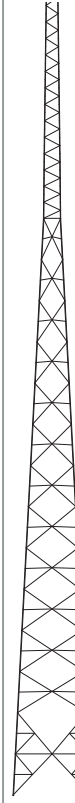





Model Designation:		M200	M300	M400	M500			
Part Number:		5.630.0219.184	5.630.0319.184	5.630.0419.184	5.630.0519.184			
Includes anchor material for concrete foundation and splice hardware.								
		#2	#3	#4	#5			
		#3	#4	#5	#6			
		#4	#5	#6	#7			
		#5	#6	#7	#8			
		#6	#7	#8	#9			
		#7	#8	#9	#10			
		#8	#9	#10	#11			
		#9	#10	#11	#12			
		#10	#11	#12	#13			
		#11	#12	#13	#14			
Allowable antenna area in ft <sup>2</sup> *	EIA Rev.G Class 1 90/105/120 mph wind 3/4" ice	Round: 42/10/-- Flat: 31/7/--	Round: 90/26/-- Flat: 60/17/--	Round: 114/48/-- Flat: 76/32/--	Round: 214/92/-- Flat: 143/61/--			
	EIA Rev.G Class 2 90/105/120 mph wind 3/4" ice	Round: 32/--/-- Flat: 21/--/--	Round: 60/10/-- Flat: 40/7/--	Round: 94/30/-- Flat: 63/20/--	Round: 166/51/-- Flat: 111/34/--			
Shipping Dimensions (L"xW"xH")		2 Bundles: 19"x10"x8" 2 Bundles: 19"x12"x8" 6 Bundles: 19"x15"x8" 1 Crate: 76"x25"x15"	2 Bundles: 19"x10"x8" 2 Bundles: 19"x12"x8" 6 Bundles: 19"x15"x8" 1 Crate: 76"x25"x15"	2 Bundles: 19"x10"x8" 2 Bundles: 19"x12"x8" 6 Bundles: 19"x15"x8" 1 Crate: 76"x25"x15"	2 Bundles: 19"x10"x8" 2 Bundles: 19"x12"x8" 6 Bundles: 19"x15"x8" 1 Crate: 76"x25"x15"			
Shipping Weight (lbs)		12000	13900	16000	18200			

\*Assumptions: Projected areas (PA) shown are bare; a 1.5 multiplier used for iced area; loads centrally located and balanced at tower top; considers step-pegs, safety cable, and one 1/2" tx line per 10 sq.ft.; "--" indicates tower failure.  
 \*Round antennas include omnis, dipoles, dishes with radomes, etc. Antennas where wind hits a round surface. Flat Antennas include flat panels, dishes without radomes and cameras, where wind hits a flat surface.  
 \*Please contact Trylon directly for more information.

## Common Accessories

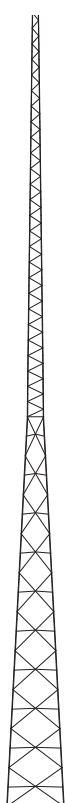
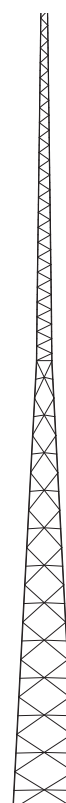
Accessory:	M200	M300	M400	M500			
<b>Cable Safety Climb Kits</b> <i>no slider</i>	4.99.0495.200	4.99.0495.200	4.99.0495.200	4.99.0495.200			
<b>Step-Bolt Kit</b> <i>leg mounted</i>	4.630.S200.184	4.630.S300.184	4.630.S400.184	4.630.S500.184			
<b>Anti-Climb Shield Kits</b>	4.630.0001.213	4.630.0001.213	4.630.0001.213	4.630.0001.213			
<b>Tower Grounding Kit</b> <i>basic, three leg</i>	4.91.0103.003	4.91.0103.003	4.91.0103.003	4.91.0103.003			



Model Designation:		M110	M210	M310	M410	M510		
Part Number:		5.630.0110.194	5.630.0210.194	5.630.0310.194	5.630.0410.194	5.630.0510.194		
Includes anchor material for concrete foundation and splice hardware.								
		#1 #2 #3 #4 #5 #6 #7 #8 #9 #10 #11	#2 #3 #4 #5 #6 #7 #8 #9 #10 #11 #12	#3 #4 #5 #6 #7 #8 #9 #10 #11 #12 #13	#4 #5 #6 #7 #8 #9 #10 #11 #12 #13 #14	#5 #6 #7 #8 #9 #10 #11 #12 #13 #14 #15		
Allowable antenna area in ft <sup>2</sup> *	EIA Rev.G Class 1 90/105/120 mph wind 3/4" ice	Round: 26/6/-- Flat: 17/4/--	Round: 62/14/-- Flat: 41/9/--	Round: 108/32/-- Flat: 72/21/--	Round: 120/62/-- Flat: 80/41/--	Round: 232/46/-- Flat: 155/31/--		
	EIA Rev.G Class 2 90/105/120 mph wind 3/4" ice	Round: 16/--/-- Flat: 11/--/--	Round: 46/--/-- Flat: 31/--/--	Round: 78/14/-- Flat: 52/9/--	Round: 102/21/-- Flat: 68/14/--	Round: 190/28/-- Flat: 127/19/--		
Shipping Dimensions (L"xW"xH")		2 Bundles: 19'x10"x8" 2 Bundles: 19'x12"x8" 6 Bundles: 19'x15"x8" 1 Crate: 76"x25"x15"	2 Bundles: 19'x10"x8" 2 Bundles: 19'x12"x8" 6 Bundles: 19'x15"x8" 1 Crate: 76"x25"x15"	2 Bundles: 19'x10"x8" 2 Bundles: 19'x12"x8" 6 Bundles: 19'x15"x8" 1 Crate: 76"x25"x15"	2 Bundles: 19'x10"x8" 2 Bundles: 19'x12"x8" 6 Bundles: 19'x15"x8" 1 Crate: 76"x25"x15"	2 Bundles: 19'x10"x8" 2 Bundles: 19'x12"x8" 6 Bundles: 19'x15"x8" 1 Crate: 76"x25"x15"		
Shipping Weight (lbs)		12200	14000	16250	18500	21200		

\*Assumptions: Projected areas (PA) shown are bare; a 1.5 multiplier used for iced area; loads centrally located and balanced at tower top; considers step-pegs, safety cable, and one 1/2" tx line per 10 sq.ft.; "--" indicates tower failure.  
 \*Round antennas include omnis, dipoles, dishes with radomes, etc. Antennas where wind hits a round surface. Flat Antennas include flat panels, dishes without radomes and cameras, where wind hits a flat surface.  
 \*Please contact Trylon directly for more information.

## Common Accessories

Accessory:	M110	M210	M310	M410	M510		
<b>Cable Safety Climb Kits</b> <i>no slider</i>	4.99.0495.200	4.99.0495.200	4.99.0495.200	4.99.0495.200	4.99.0495.200		
<b>Step-Bolt Kit</b> <i>leg mounted</i>	4.630.S110.194	4.630.S210.194	4.630.S310.194	4.630.S410.194	4.630.S510.194		
<b>Anti-Climb Shield Kits</b>	4.630.0001.213	4.630.0001.213	4.630.0001.213	4.630.0001.213	4.630.0001.213		
<b>Tower Grounding Kit</b> <i>basic, three leg</i>	4.91.0103.003	4.91.0103.003	4.91.0103.003	4.91.0103.003	4.91.0103.003		

# 203' Towers

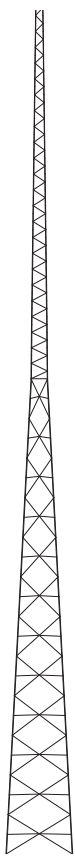
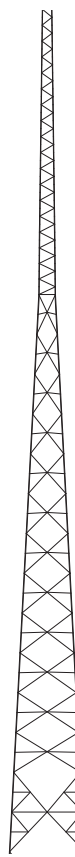
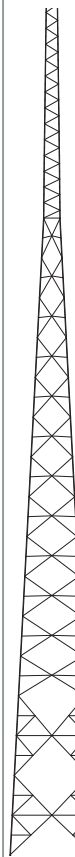
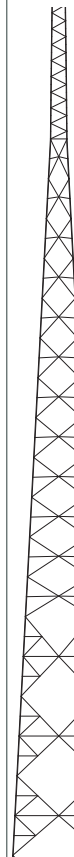

Model Designation:		M200	M300	M400	M500			
Part Number:		5.630.0219.203	5.630.0319.203	5.630.0419.203	5.630.0519.203			
Includes anchor material for concrete foundation and splice hardware.								
		#2 #3 #4 #5 #6 #7 #8 #9 #10 #11 #12	#3 #4 #5 #6 #7 #8 #9 #10 #11 #12 #13	#4 #5 #6 #7 #8 #9 #10 #11 #12 #13 #14	#5 #6 #7 #8 #9 #10 #11 #12 #13 #14 #15			
Allowable antenna area in ft <sup>2</sup> *	EIA Rev.G Class 1 90/105/120 mph wind 3/4" ice	Round: 40/4/- Flat: 27/3/-	Round: 88/20/- Flat: 59/13/-	Round: 112/46/- Flat: 75/31/-	Round: 206/46/- Flat: 137/31/-			
	EIA Rev.G Class 2 90/105/120 mph wind 3/4" ice	Round: 30/-/- Flat: 20/-/-	Round: 54/4/- Flat: 36/3/-	Round: 92/8/- Flat: 61/5/-	Round: 156/11/- Flat: 104/7/-			
Shipping Dimensions (L"xW"xH")		9 Bundles: 19"x10"x8" 12 Bundles: 19"x15"x8" 6 Bundle: 19"x18"x8" 6 Crate: 76"x25"x15"	10 Bundles: 19"x10"x8" 13 Bundles: 19"x15"x8" 7 Bundle: 19"x18"x8" 7 Crate: 76"x25"x15"	11 Bundles: 19"x10"x8" 14 Bundles: 19"x15"x8" 8 Bundle: 19"x18"x8" 8 Crate: 76"x25"x15"	12 Bundles: 19"x10"x8" 15 Bundles: 19"x15"x8" 9 Bundle: 19"x18"x8" 9 Crate: 76"x25"x15"			
Shipping Weight (lbs)		14200	16500	18700	21600			



\*Assumptions: Projected areas (PA) shown are bare; a 1.5 multiplier used for iced area; loads centrally located and balanced at tower top; considers step-pegs, safety cable, and one 1/2" tx line per 10 sq.ft.; "-" indicates tower failure.  
 \*Round antennas include omnis, dipoles, dishes with radomes, etc. Antennas where wind hits a round surface. Flat Antennas include flat panels, dishes without radomes and cameras, where wind hits a flat surface.  
 \*Please contact Tylon directly for more information.

## Common Accessories

Accessory:	M200	M300	M400	M500			
<b>Cable Safety Climb Kits</b> <i>no slider</i>	4.99.0495.250	4.99.0495.250	4.99.0495.250	4.99.0495.250			
<b>Step-Bolt Kit</b> <i>leg mounted</i>	4.630.S200.203	4.630.S300.203	4.630.S400.203	4.630.S500.203			
<b>Anti-Climb Shield Kits</b>	4.630.0001.213	4.630.0001.213	4.630.0001.213	4.630.0001.213			
<b>Tower Grounding Kit</b> <i>basic, three leg</i>	4.91.0103.003	4.91.0103.003	4.91.0103.003	4.91.0103.003			



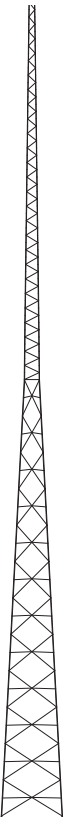
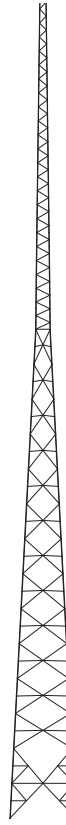

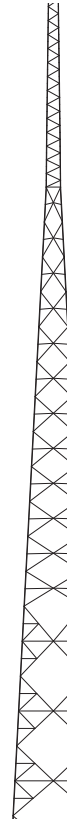
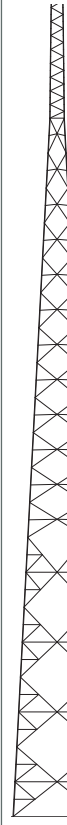
Model Designation:		M110	M210	M310	M410	M510		
Part Number:		5.630.0110.213	5.630.0210.213	5.630.0310.213	5.630.0410.213	5.630.0510.213		
Includes anchor material for concrete foundation and splice hardware.								
		#1 #2 #3 #4 #5 #6 #7 #8 #9 #10 #11 #12	#2 #3 #4 #5 #6 #7 #8 #9 #10 #11 #12 #13	#3 #4 #5 #6 #7 #8 #9 #10 #11 #12 #13 #14	#4 #5 #6 #7 #8 #9 #10 #11 #12 #13 #14 #15	#5 #6 #7 #8 #9 #10 #11 #12 #13 #14 #15 #16		
Allowable antenna area in ft <sup>2</sup> *	EIA Rev.G Class 1 90/105/120 mph wind 3/4" ice	Round: 26/-- Flat: 17/--	Round: 60/12/-- Flat: 40/8/--	Round: 104/30/-- Flat: 69/20/--	Round: 118/38/-- Flat: 79/25/--	Round: 228/41/-- Flat: 152/27/--		
	EIA Rev.G Class 2 90/105/120 mph wind 3/4" ice	Round: 16/-- Flat: 11/--	Round: 46/-- Flat: 31/--	Round: 72/-- Flat: 48/--	Round: 100/-- Flat: 67/--	Round: 174/-- Flat: 116/--		
Shipping Dimensions (L"xW"xH")		4 Bundles: 19'x10"x8" 7 Bundles: 19'x15"x8" 1 Bundle: 19'x18"x8" 1 Crate: 76"x25"x15"	5 Bundles: 19'x10"x8" 8 Bundles: 19'x15"x8" 2 Bundle: 19'x18"x8" 2 Crate: 76"x25"x15"	6 Bundles: 19'x10"x8" 9 Bundles: 19'x15"x8" 3 Bundle: 19'x18"x8" 3 Crate: 76"x25"x15"	7 Bundles: 19'x10"x8" 10 Bundles: 19'x15"x8" 4 Bundle: 19'x18"x8" 4 Crate: 76"x25"x15"	8 Bundles: 19'x10"x8" 11 Bundles: 19'x15"x8" 5 Bundle: 19'x18"x8" 5 Crate: 76"x25"x15"		
Shipping Weight (lbs)		14600	16900	19200	22100	25000		



\*Assumptions: Projected areas (PA) shown are bare; a 1.5 multiplier used for iced area; loads centrally located and balanced at tower top; considers step-pegs, safety cable, and one 1/2" tx line per 10 sq.ft.; "--" indicates tower failure.  
 \*Round antennas include omnis, dipoles, dishes with radomes, etc. Antennas where wind hits a round surface. Flat Antennas include flat panels, dishes without radomes and cameras, where wind hits a flat surface.  
 \*Please contact Trylon directly for more information.

## Common Accessories

Accessory:	M110	M210	M310	M410	M510		
<b>Cable Safety Climb Kits</b> <i>no slider</i>	4.99.0495.250	4.99.0495.250	4.99.0495.250	4.99.0495.250	4.99.0495.250		
<b>Step-Bolt Kit</b> <i>leg mounted</i>	4.630.5110.213	4.630.5210.213	4.630.5310.213	4.630.5410.213	4.630.5510.213		
<b>Anti-Climb Shield Kits</b>	4.630.0001.213	4.630.0001.213	4.630.0001.213	4.630.0001.213	4.630.0001.213		
<b>Tower Grounding Kit</b> <i>basic, three leg</i>	4.91.0103.003	4.91.0103.003	4.91.0103.003	4.91.0103.003	4.91.0103.003		

# 222' Towers

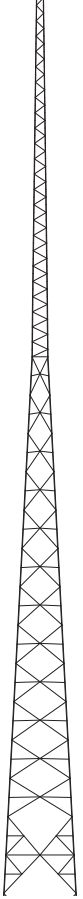
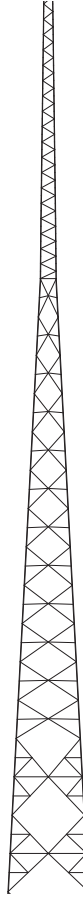
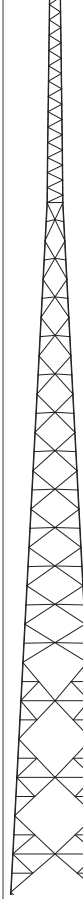
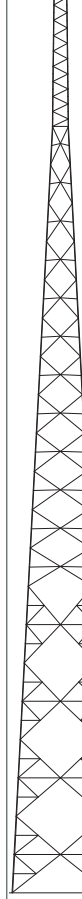

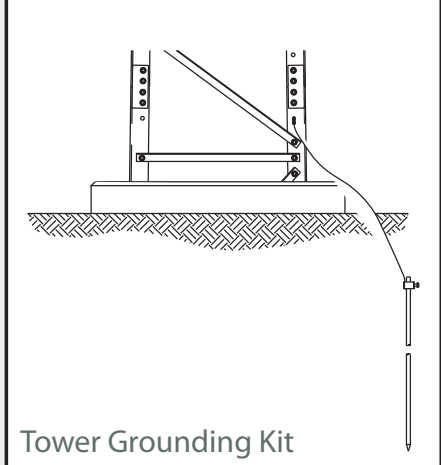

Model Designation:		M200	M300	M400	M500			
Part Number:		5.630.0219.222	5.630.0319.222	5.630.0419.222	5.630.0519.222			
Includes anchor material for concrete foundation and splice hardware.								
		#2 #3 #4 #5 #6 #7 #8 #9 #10 #11 #12 #13	#3 #4 #5 #6 #7 #8 #9 #10 #11 #12 #13 #14	#4 #5 #6 #7 #8 #9 #10 #11 #12 #13 #14 #15	#5 #6 #7 #8 #9 #10 #11 #12 #13 #14 #15 #16			
Allowable antenna area in ft <sup>2</sup> *	EIA Rev.G Class 1 90/105/120 mph wind 3/4" ice	Round: 40/4/- Flat: 27/-/-	Round: 82/16/- Flat: 55/11/-	Round: 108/26/- Flat: 72/17/-	Round: 298/32/- Flat: 132/21/-			
	EIA Rev.G Class 2 90/105/120 mph wind 3/4" ice	Round: 30/-/- Flat: 20/-/-	Round: 52/-/- Flat: 35/-/-	Round: 90/-/- Flat: 60/-/-	Round: 142/-/- Flat: 95/-/-			
Shipping Dimensions (L"xW"xH")		8 Bundles: 19"x10"x8" 12 Bundles: 19"x15"x8" 5 Bundle: 19"x18"x8" 5 Crate: 76"x25"x15"	9 Bundles: 19"x10"x8" 13 Bundles: 19"x15"x8" 6 Bundle: 19"x18"x8" 6 Crate: 76"x25"x15"	10 Bundles: 19"x10"x8" 14 Bundles: 19"x15"x8" 7 Bundle: 19"x18"x8" 7 Crate: 76"x25"x15"	11 Bundles: 19"x10"x8" 15 Bundles: 19"x15"x8" 8 Bundle: 19"x18"x8" 8 Crate: 76"x25"x15"			
Shipping Weight (lbs)		17000	19400	22400	25400			

\*Assumptions: Projected areas (PA) shown are bare; a 1.5 multiplier used for iced area; loads centrally located and balanced at tower top; considers step-pegs, safety cable, and one 1/2" tx line per 10 sq.ft.; "-" indicates tower failure.  
 \*Round antennas include omnis, dipoles, dishes with radomes, etc. Antennas where wind hits a round surface. Flat Antennas include flat panels, dishes without radomes and cameras, where wind hits a flat surface.  
 \*Please contact Trylon directly for more information.

## Common Accessories

Accessory:	M200	M300	M400	M500			
<b>Cable Safety Climb Kits</b> <i>no slider</i>	4.99.0495.250	4.99.0495.250	4.99.0495.250	4.99.0495.250			
<b>Step-Bolt Kit</b> <i>leg mounted</i>	4.630.S200.222	4.630.S300.222	4.630.S400.222	4.630.S500.222			
<b>Anti-Climb Shield Kits</b>	4.630.0001.213	4.630.0001.213	4.630.0001.213	4.630.0001.213			

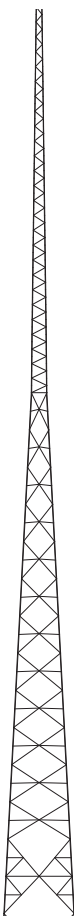
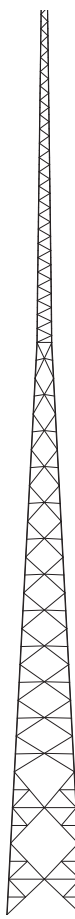
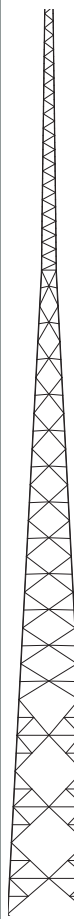
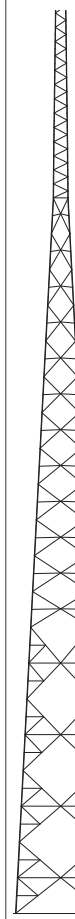

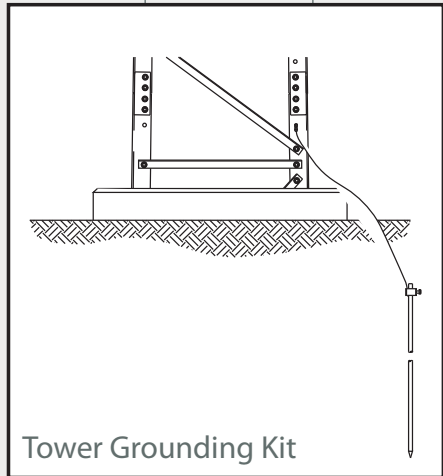
Model Designation:		M110	M210	M310	M410			
Part Number:		5.630.0110.232	5.630.0210.232	5.630.0310.232	5.630.0410.232			
Includes anchor material for concrete foundation and splice hardware.								
		#1 #2 #3 #4 #5 #6 #7 #8 #9 #10 #11 #12 #13	#2 #3 #4 #5 #6 #7 #8 #9 #10 #11 #12 #13 #14	#3 #4 #5 #6 #7 #8 #9 #10 #11 #12 #13 #14 #15	#4 #5 #6 #7 #8 #9 #10 #11 #12 #13 #14 #15 #16			
Allowable antenna area in ft <sup>2</sup> *	EIA Rev.G Class 1 90/105/120 mph wind 3/4" ice	Round: 24/-- Flat: 16/--	Round: 58/8-- Flat: 39/5--	Round: 100/14-- Flat: 67/9--	Round: 116/18-- Flat: 77/12--			
	EIA Rev.G Class 2 90/105/120 mph wind 3/4" ice	Round: 14/-- Flat: 9/--	Round: 42/-- Flat: 28/--	Round: 66/-- Flat: 44/--	Round: 98/-- Flat: 65/--			
Shipping Dimensions (L"xW"xH")		4 Bundles: 19"x10"x8" 8 Bundles: 19"x15"x8" 1 Bundle: 19"x18"x8" 1 Crate: 76"x25"x15"	5 Bundles: 19"x10"x8" 9 Bundles: 19"x15"x8" 2 Bundle: 19"x18"x8" 2 Crate: 76"x25"x15"	6 Bundles: 19"x10"x8" 10 Bundles: 19"x15"x8" 3 Bundle: 19"x18"x8" 3 Crate: 76"x25"x15"	7 Bundles: 19"x10"x8" 11 Bundles: 19"x15"x8" 4 Bundle: 19"x18"x8" 4 Crate: 76"x25"x15"			
Shipping Weight (lbs)		17200	19600	22550	25700			



\*Assumptions: Projected areas (PA) shown are bare; a 1.5 multiplier used for iced area; loads centrally located and balanced at tower top; considers step-pegs, safety cable, and one 1/2" tx line per 10 sq.ft.; "--" indicates tower failure.  
 \*Round antennas include omnis, dipoles, dishes with radomes, etc. Antennas where wind hits a round surface. Flat Antennas include flat panels, dishes without radomes and cameras, where wind hits a flat surface.  
 \*Please contact Trylon directly for more information.

## Common Accessories

Accessory:	M110	M210	M310	M410			
<b>Cable Safety Climb Kits</b> <i>no slider</i>	4.99.0495.250	4.99.0495.250	4.99.0495.250	4.99.0495.250			
<b>Step-Bolt Kit</b> <i>leg mounted</i>	4.630.5110.232	4.630.5210.232	4.630.5310.232	4.630.5410.232			
<b>Anti-Climb Shield Kits</b>	4.630.0001.213	4.630.0001.213	4.630.0001.213	4.630.0001.213			

# 241' Towers

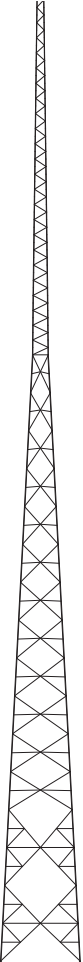
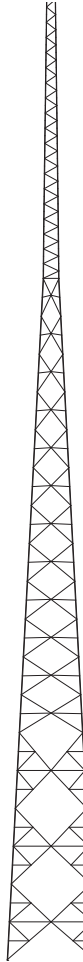
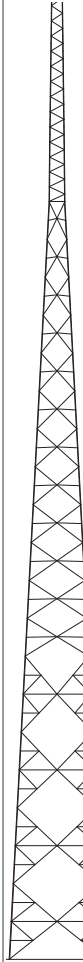

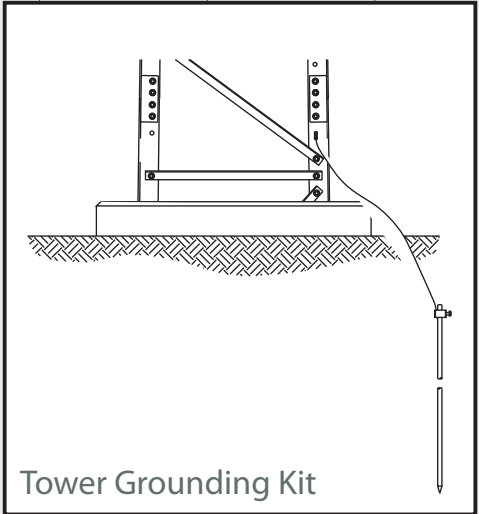

Model Designation:		M200	M300	M400				
Part Number:		5.630.0219.241	5.630.0319.241	5.630.0419.241				
Includes anchor material for concrete foundation and splice hardware.								
		#2 #3 #4 #5 #6 #7 #8 #9 #10 #11 #12 #13 #14	#3 #4 #5 #6 #7 #8 #9 #10 #11 #12 #13 #14 #15	#4 #5 #6 #7 #8 #9 #10 #11 #12 #13 #14 #15 #16				
Allowable antenna area in ft <sup>2</sup> *	EIA Rev.G Class 1 90/105/120 mph wind 3/4" ice	Round: 38/4/- Flat: 25/-/-	Round: 76/4/- Flat: 51/3/-	Round: 106/8/- Flat: 71/5/-				
	EIA Rev.G Class 2 90/105/120 mph wind 3/4" ice	Round: 30/-/- Flat: 20/-/-	Round: 50/-/- Flat: 33/-/-	Round: 86/-/- Flat: 57/-/-				
Shipping Dimensions (L"xW"xH")		4 Bundles: 19"x10"x8" 9 Bundles: 19"x15"x8" 1 Bundle: 19"x18"x8" 1 Crate: 76"x25"x15"	4 Bundles: 19"x10"x8" 9 Bundles: 19"x15"x8" 1 Bundle: 19"x18"x8" 1 Crate: 76"x25"x15"	4 Bundles: 19"x10"x8" 9 Bundles: 19"x15"x8" 1 Bundle: 19"x18"x8" 1 Crate: 76"x25"x15"				
Shipping Weight (lbs)		19700	22800	25900				

\*Assumptions: Projected areas (PA) shown are bare; a 1.5 multiplier used for iced area; loads centrally located and balanced at tower top; considers step-pegs, safety cable, and one 1/2" tx line per 10 sq.ft.; "-" indicates tower failure.  
 \*Round antennas include omnis, dipoles, dishes with radomes, etc. Antennas where wind hits a round surface. Flat Antennas include flat panels, dishes without radomes and cameras, where wind hits a flat surface.  
 \*Please contact Tylon directly for more information.

## Common Accessories

Accessory	M100	M200	M300				
<b>Cable Safety Climb Kits</b> <i>no slider</i>	4.99.0495.250	4.99.0495.250	4.99.0495.250				
<b>Step-Bolt Kit</b> <i>leg mounted</i>	4.630.S200.241	4.630.S300.241	4.630.S400.241				

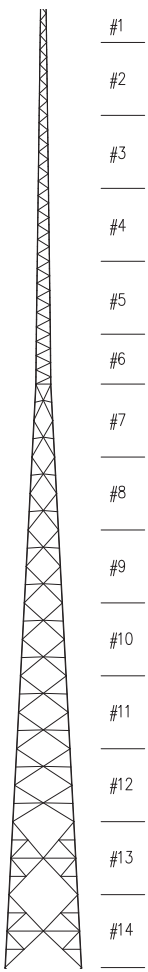
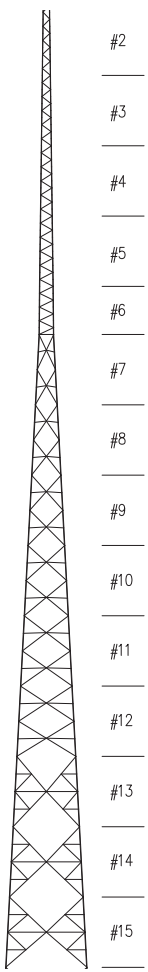
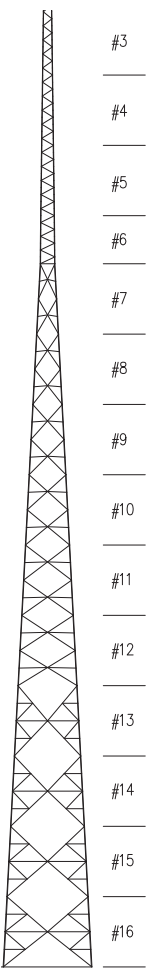

Model Designation:		M110	M210	M310			
Part Number		5.630.0110.251	5.630.0210.251	5.630.0310.251			
Includes anchor material for concrete foundation and splice hardware.							
Allowable antenna area in ft <sup>2</sup> *	EIA Rev.G Class 1 90/105/120 mph wind 3/4" ice	Round: 22/-- Flat: 15/--	Round: 54/-- Flat: 36/--	Round: 96/-- Flat: 64/--			
	EIA Rev.G Class 2 90/105/120 mph wind 3/4" ice	Round: 14/-- Flat: 9/--	Round: 38/-- Flat: 25/--	Round: 60/-- Flat: 40/--			
Shipping Dimensions (L"xW"xH")		4 Bundles: 19'x10"x8" 9 Bundles: 19'x15"x8" 1 Bundle: 19'x18"x8" 1 Crate: 76"x25"x15"	4 Bundles: 19'x10"x8" 9 Bundles: 19'x15"x8" 1 Bundle: 19'x18"x8" 1 Crate: 76"x25"x15"	4 Bundles: 19'x10"x8" 9 Bundles: 19'x15"x8" 1 Bundle: 19'x18"x8" 1 Crate: 76"x25"x15"			
Shipping Weight (lbs)		19900	23000	26100			

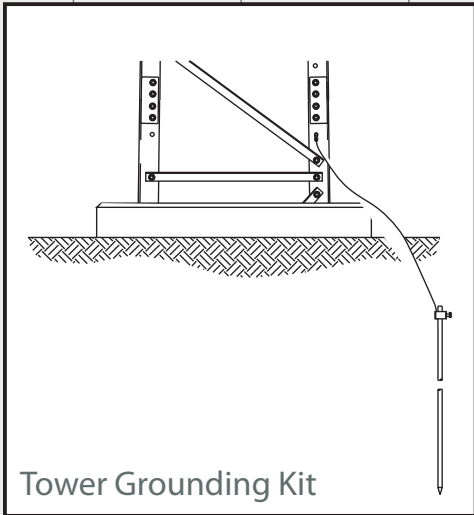



\*Assumptions: Projected areas (PA) shown are bare; a 1.5 multiplier used for iced area; loads centrally located and balanced at tower top; considers step-pegs, safety cable, and one 1/2" tx line per 10 sq.ft.; "--" indicates tower failure.  
 \*Round antennas include omnis, dipoles, dishes with radomes, etc. Antennas where wind hits a round surface. Flat Antennas include flat panels, dishes without radomes and cameras, where wind hits a flat surface.  
 \*Please contact Trylon directly for more information.

## Common Accessories

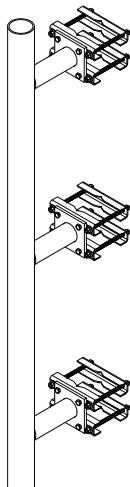
Accessory	M110	M210	M310			
<b>Cable Safety Climb Kits</b> <i>no slider</i>	4.99.0495.250	4.99.0495.250	4.99.0495.250			
<b>Step-Bolt Kit</b> <i>leg mounted</i>	4.630.S110.251	4.630.S210.251	4.630.S310.251			

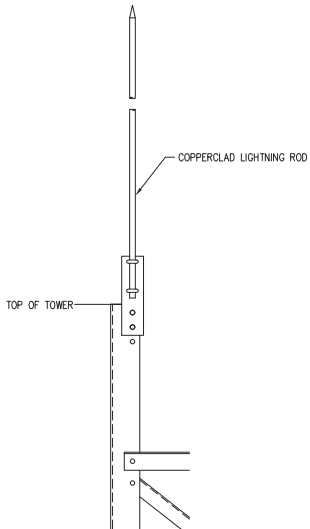
Description:	Beacon Light Kit/Strobe Kit	Heavy Stand-Off Mounts
Part Number	Varies	Varies
	 <p><i>Beacon Light Kit</i></p> <p><i>Strobe Kit</i></p>	

Description:	Lightning Rod	Factory Painted Towers - Orange & White, Water-Based
Part Number	4.90.0200.C05	Varies
	 <p>COPPERCLAD LIGHTNING ROD</p> <p>TOP OF TOWER</p>	





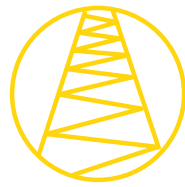

# SUPER TITAN™ WELD

- .. TIA/EIA 222 F and G Compliant
- .. Up to 150' Self-Support Tower
- .. Standard 10' sections
- .. Flat flanges provides an easy connection between sections (3 bolts per leg)
- .. All-Weld sections minimize assembly and installation time
- .. Applications:
  - ... 2-way applications
  - ... Wireless broadband
  - ... SCADA

The SuperTitan Weld is designed to meet market loading requirements and conforms to ANSI-TIA 222-G Standard. Tylon understands the importance of minimizing freight costs and as a result the tower is designed to ship nested.

The all-weld design uses flat pads allows for easy connections, which further minimizes assembly and installation time. The tower ships with integral climbing face and transmission line supports which offer additional value and eliminate the need to purchase separately. P.E. stamped drawings are available.

### SUPERTITAN WELD SPECIFICATIONS

- All-Weld sections minimize assembly and installation time
- Flat flanges provides an easy connection between sections (3 bolts per leg)
- Designed to conform with ANSI-TIA-222 F&G Standard
- Climbing horizontals on one face (7/8" or 3/4")
- Every 5th section nests for reduced freight costs
- Maximum height: 150ft
- Section height: 10ft

### SUPERTITAN WELD APPLICATIONS

- Oil and gas sites
- Railways: minimizes access time required
- Tower Contractors: minimizes assembly
- Ideal loading capacity for SCADA, WISP, Broadband and 2-Way applications

### THE SUPERTITAN WELD DIFFERENCE

- Only All-Weld Self-Support available through distribution
- 3 hole bolts pattern and flat flanges
- Towers ship nested to minimizes freight costs



**The flat pads make installation easy**



**Tower ships nested to minimize freight**



**Integral transmission line supports**

# 20' Towers



Model Designation:		W080	W100	W200	W300	W400	W500	W600
Part Number:		5.640.0080.020	5.640.0100.020	5.640.0200.020	5.640.0300.020	5.640.0400.020	5.640.0500.020	5.640.0600.020
		Sec #1 Sec #1	Sec #1 Sec #2	Sec #2 Sec #3	Sec #3 Sec #4	Sec #4 Sec #5	Sec #5 Sec #6	Sec #6 Sec #7
Allowable antenna area in ft <sup>2</sup> at:*	EIA Rev.G Class 1 90/105/120 mph wind 3/4" ice	--/--/*	<b>86/54/38</b>	<b>178/114/76</b>	<b>182/116/78</b>	<b>184/118/80</b>	<b>186/120/82</b>	<b>188/122/84</b>
	EIA Rev.G Class 2 90/105/120 mph wind 3/4" ice	--/--/*	<b>74/46/32</b>	<b>154/96/62</b>	<b>156/98/64</b>	<b>158/100/66</b>	<b>160/102/68</b>	<b>162/104/72</b>
Shipping Weight (lbs)		550	880	1071	1244	1388	1579	1631

\*Assumptions: Projected areas (PA) shown are bare; a 1.5 multiplier used for iced area; loads centrally located and balanced at tower top; considers step-pegs, safety cable, and one 1/2" tx line per 10 sq.ft.; "--" indicates tower failure.  
 \*Round antennas include omnis, dipoles, dishes with radomes, etc. Antennas where wind hits a round surface. Flat Antennas include flat panels, dishes without radomes and cameras, where wind hits a flat surface.  
 \*Please contact Trylon directly for more information.

## Common Accessories

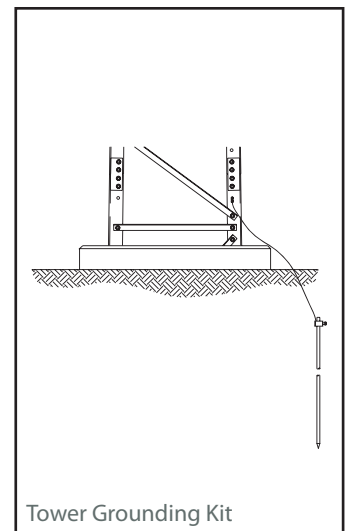

Accessory:	W080	W100	W200	W300	W400	W500	W600
<b>Cable Safety Climb Kits</b> <i>no slider</i>	4.99.0220.000	4.99.0220.000	4.99.0220.000	4.99.0220.000	4.99.0220.000	4.99.0220.000	4.99.0220.000
<b>Lighting Kit</b>	4.942.1024.150	4.942.1024.150	4.942.1024.150	4.942.1024.150	4.942.1024.150	4.942.1024.150	4.942.1024.150
<b>Anti-Climb Shield Kits</b>	4.936.0026.001	4.936.0026.002	4.936.0026.003	4.936.0026.004	4.936.0026.005	4.936.0026.006	4.936.0026.007
<b>Tower Grounding Kit</b> <i>basic, single leg</i>	4.912.1177.100	4.912.1177.100	4.912.1177.125	4.912.1177.150	4.912.1177.175	4.912.1177.175	4.912.1177.175

For more SuperTitan Weld Accessories and Replacement Parts, see pages 61 to 76.



Model Designation:		W060	W080	W100	W200	W300	W400	W500
Part Number:		5.640.0060.030	5.640.0080.030	5.640.0100.030	5.640.0200.030	5.640.0300.030	5.640.0400.030	5.640.0500.030
		Sec #1 Sec #1 Sec #1	Sec #1 Sec #1 Sec #2	Sec #1 Sec #2 Sec #3	Sec #2 Sec #3 Sec #4	Sec #3 Sec #4 Sec #5	Sec #4 Sec #5 Sec #6	Sec #5 Sec #6 Sec #7
Allowable antenna area in ft <sup>2</sup> at*:	EIA Rev.G Class 1 90/105/120 mph wind 3/4" ice	--/--*	--/--*	<b>78/50/34</b>	<b>124/78/52</b>	<b>164/104/70</b>	<b>166/106/72</b>	<b>168/108/74</b>
	EIA Rev.G Class 2 90/105/120 mph wind 3/4" ice	--/--*	--/--*	<b>66/44/30</b>	<b>106/66/46</b>	<b>142/88/58</b>	<b>144/90/60</b>	<b>146/92/62</b>
Shipping Weight (lbs)		700	1,093	1,291	1,455	1,704	1,961	2,089

\*Assumptions: Projected areas (PA) shown are bare; a 1.5 multiplier used for iced area; loads centrally located and balanced at tower top; considers step-pegs, safety cable, and one 1/2" tx line per 10 sq.ft.; "--" indicates tower failure.  
 \*Round antennas include omnis, dipoles, dishes with radomes, etc. Antennas where wind hits a round surface. Flat Antennas include flat panels, dishes without radomes and cameras, where wind hits a flat surface.  
 \*Please contact Trylon directly for more information.

## Common Accessories

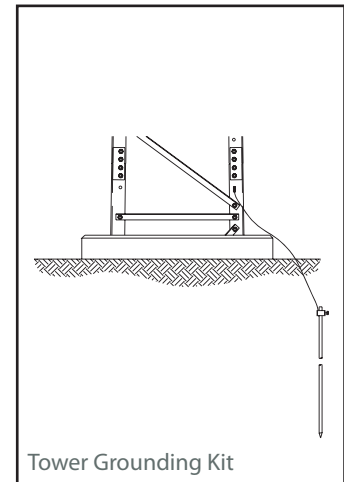

Accessory:	W060	W080	W100	W200	W300	W400	W500
<b>Cable Safety Climb Kits</b> <i>no slider</i>	4.99.0250.000	4.99.0250.000	4.99.0250.000	4.99.0250.000	4.99.0250.000	4.99.0250.000	4.99.0250.000
<b>Lighting Kit</b>	4.942.1024.150	4.942.1024.150	4.942.1024.150	4.942.1024.150	4.942.1024.150	4.942.1024.150	4.942.1024.150
<b>Anti-Climb Shield Kits</b>	4.936.0026.001	4.936.0026.002	4.936.0026.003	4.936.0026.004	4.936.0026.005	4.936.0026.006	4.936.0026.007
<b>Tower Grounding Kit</b> <i>basic, single leg</i>	4.912.1177.100	4.912.1177.100	4.912.1177.125	4.912.1177.150	4.912.1177.175	4.912.1177.175	4.912.1177.175

For more SuperTitan Weld Accessories and Replacement Parts, see pages 61 to 76.



# 40' Towers

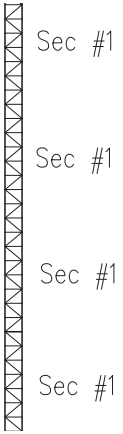
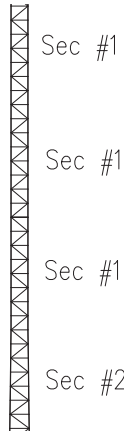
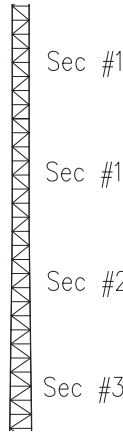
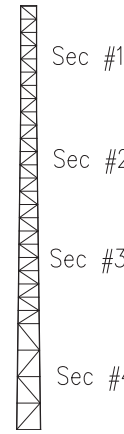
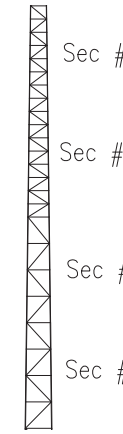
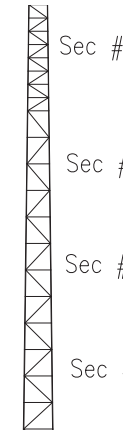
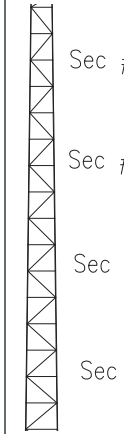

Model Designation:		W040	W060	W080	W100	W200	W300	W400
Part Number:		5.640.0040.040	5.640.0060.040	5.640.0080.040	5.640.0100.040	5.640.0200.040	5.640.0300.040	5.640.0400.040
								
Allowable antenna area in ft <sup>2</sup> at.*	EIA Rev.G Class 1 90/105/120 mph wind 3/4" ice	--/--/*	--/--/*	--/--/*	<b>72/46/32</b>	<b>116/72/50</b>	<b>154/98/64</b>	<b>156/100/66</b>
	EIA Rev.G Class 2 90/105/120 mph wind 3/4" ice	--/--/*	--/--/*	--/--/*	<b>62/40/28</b>	<b>98/62/42</b>	<b>132/82/52</b>	<b>134/84/54</b>
Shipping Weight (lbs)		1,020	1,245	1,510	1,675	1,915	2,278	2,471

\*Assumptions: Projected areas (PA) shown are bare; a 1.5 multiplier used for iced area; loads centrally located and balanced at tower top; considers step-pegs, safety cable, and one 1/2" tx line per 10 sq.ft.; "--" indicates tower failure.  
 \*Round antennas include omnis, dipoles, dishes with radomes, etc. Antennas where wind hits a round surface. Flat Antennas include flat panels, dishes without radomes and cameras, where wind hits a flat surface.  
 \*Please contact Trylon directly for more information.

## Common Accessories

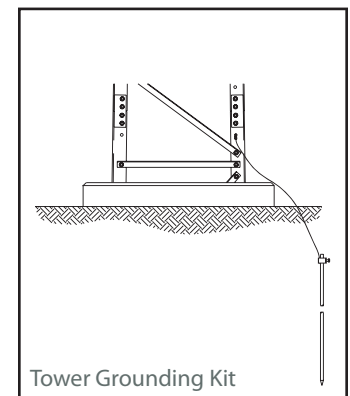

Accessory:	W040	W060	W080	W100	W200	W300	W400
<b>Cable Safety Climb Kits</b> <i>no slider</i>	4.99.0250.000	4.99.0250.000	4.99.0250.000	4.99.0250.000	4.99.0250.000	4.99.0250.000	4.99.0250.000
<b>Lighting Kit</b>	4.942.1024.150	4.942.1024.150	4.942.1024.150	4.942.1024.150	4.942.1024.150	4.942.1024.150	4.942.1024.150
<b>Anti-Climb Shield Kits</b>	4.936.0026.001	4.936.0026.002	4.936.0026.003	4.936.0026.004	4.936.0026.005	4.936.0026.006	4.936.0026.007
<b>Tower Grounding Kit</b> <i>basic, single leg</i>	4.912.1177.100	4.912.1177.100	4.912.1177.125	4.912.1177.150	4.912.1177.175	4.912.1177.175	4.912.1177.175

For more SuperTitan Weld Accessories and Replacement Parts, see pages 61 to 76.





Model Designation:	W020	W040	W060	W080	W100	W200	W300	
Part Number:	5.640.0020.050	5.640.0040.050	5.640.0060.050	5.640.0080.050	5.640.0100.050	5.640.0200.050	5.640.0300.050	
	Sec #1 Sec #1 Sec #1 Sec #1 Sec #1	Sec #1 Sec #1 Sec #1 Sec #1 Sec #2	Sec #1 Sec #1 Sec #1 Sec #2 Sec #3	Sec #1 Sec #1 Sec #2 Sec #3 Sec #4	Sec #1 Sec #2 Sec #3 Sec #4 Sec #5	Sec #2 Sec #3 Sec #4 Sec #5 Sec #6	Sec #3 Sec #4 Sec #5 Sec #6 Sec #7	
Allowable antenna area in ft <sup>2</sup> at:	EIA Rev.G Class 1 90/105/120 mph wind 3/4" ice	--/--/*	--/--/*	--/--/*	--/--/*	<b>14/6/-</b>	<b>30/16/8</b>	<b>52/34/22</b>
	EIA Rev.G Class 2 90/105/120 mph wind 3/4" ice	--/--/*	--/--/*	--/--/*	--/--/*	<b>12/-/-</b>	<b>24/12/4</b>	<b>44/28/16</b>
Shipping Weight (lbs)	1,215	1,385	1,620	1,894	2,135	2,489	2,788	

\*Assumptions: Projected areas (PA) shown are bare; a 1.5 multiplier used for iced area; loads centrally located and balanced at tower top; considers step-pegs, safety cable, and one 1/2" tx line per 10 sq.ft.; "--" indicates tower failure.  
 \*Round antennas include omnis, dipoles, dishes with radomes, etc. Antennas where wind hits a round surface. Flat Antennas include flat panels, dishes without radomes and cameras, where wind hits a flat surface.  
 \*Please contact Trylon directly for more information.

## Common Accessories

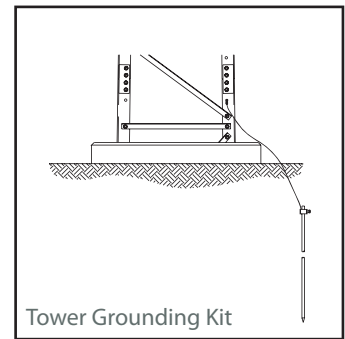
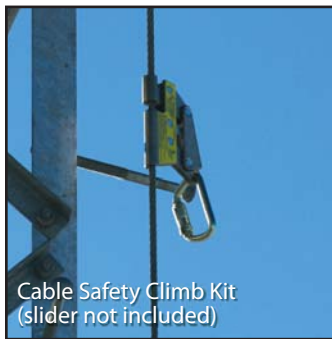

Accessory:	W020	W040	W060	W080	W100	W200	W300
<b>Cable Safety Climb Kits</b> <i>no slider</i>	4.99.0250.000	4.99.0250.000	4.99.0250.000	4.99.0250.000	4.99.0250.000	4.99.0250.000	4.99.0250.000
<b>Lighting Kit</b>	4.942.1024.150	4.942.1024.150	4.942.1024.150	4.942.1024.150	4.942.1024.150	4.942.1024.150	4.942.1024.150
<b>Anti-Climb Shield Kits</b>	4.936.0026.001	4.936.0026.002	4.936.0026.003	4.936.0026.004	4.936.0026.005	4.936.0026.006	4.936.0026.007
<b>Tower Grounding Kit</b> <i>basic, single leg</i>	4.912.1177.100	4.912.1177.100	4.912.1177.125	4.912.1177.150	4.912.1177.175	4.912.1177.175	4.912.1177.175

For more SuperTitan Weld Accessories and Replacement Parts, see pages 61 to 76.

Model Designation:		W400	W500	W600	W700	W800	W900	W1000
Part Number:		5.640.0400.050	5.640.0500.050	5.640.0600.050	5.640.0700.050	5.640.0800.050	5.640.0900.050	5.640.1000.050
Allowable antenna area in ft <sup>2</sup> at:*	EIA Rev.G Class 1 90/105/120 mph wind 3/4" ice	<b>82/50/32</b>	<b>88/54/34</b>	<b>128/84/54</b>	--/--*	--/--*	--/--*	--/--*
	EIA Rev.G Class 2 90/105/120 mph wind 3/4" ice	<b>66/42/24</b>	<b>72/44/28</b>	<b>108/68/44</b>	--/--*	--/--*	--/--*	--/--*
Shipping Weight (lbs)		3,069	3,345	3,602	3,944	4,303	4,689	5,083

\*Assumptions: Projected areas (PA) shown are bare; a 1.5 multiplier used for iced area; loads centrally located and balanced at tower top; considers step-pegs, safety cable, and one 1/2" tx line per 10 sq.ft.; "--" indicates tower failure.  
 \*Round antennas include omnis, dipoles, dishes with radomes, etc. Antennas where wind hits a round surface. Flat Antennas include flat panels, dishes without radomes and cameras, where wind hits a flat surface.  
 \*Please contact Trylon directly for more information.

## Common Accessories

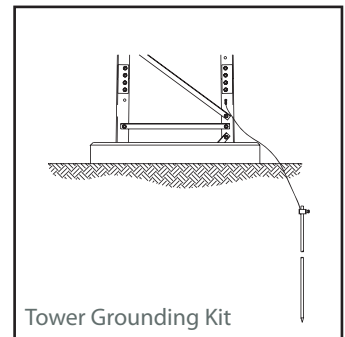
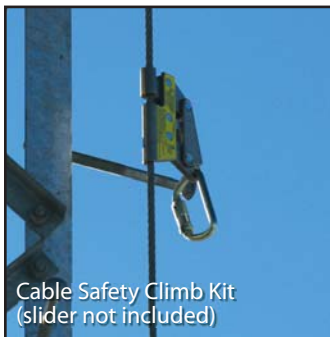

Accessory:	W400	W500	W600	W700	W800	W900	W1000
<b>Cable Safety Climb Kits</b> <i>no slider</i>	4.99.0250.000	4.99.0250.000	4.99.0250.000	4.99.0250.000	4.99.0250.000	4.99.0250.000	4.99.0250.000
<b>Lighting Kit</b>	4.942.1024.150	4.942.1024.150	4.942.1024.150	4.942.1024.150	4.942.1024.150	4.942.1024.150	4.942.1024.150
<b>Anti-Climb Shield Kits</b>	4.936.0026.008	4.936.0026.009	4.936.0026.010	4.936.0026.011	4.936.0026.012	4.936.0026.013	4.936.0026.014
<b>Tower Grounding Kit</b> <i>basic, single leg</i>	4.912.1177.225	4.912.1177.225	4.912.1177.225	4.912.1177.250	4.912.1177.250	4.912.1177.250	4.912.1177.250

For more SuperTitan Weld Accessories and Replacement Parts, see pages 61 to 76.

Model Designation:		W020	W040	W060	W080	W100	W200	W300
Part Number:		5.640.0020.060	5.640.0040.060	5.640.0060.060	5.640.0080.060	5.640.0100.060	5.640.0200.060	5.640.0300.060
Allowable antenna area in ft <sup>2</sup> at:*	EIA Rev.G Class 1 90/105/120 mph wind 3/4" ice	--/--*	--/--*	--/--*	--/--*	<b>14/4/-</b>	<b>28/14/6</b>	<b>50/30/16</b>
	EIA Rev.G Class 2 90/105/120 mph wind 3/4" ice	--/--*	--/--*	--/--*	--/--*	<b>10/-/-</b>	<b>22/10/2</b>	<b>42/22/10</b>
Shipping Weight (lbs)		1,600	1,785	2,025	2,354	2,708	2,999	3,386

\*Assumptions: Projected areas (PA) shown are bare; a 1.5 multiplier used for iced area; loads centrally located and balanced at tower top; considers step-pegs, safety cable, and one 1/2" tx line per 10 sq.ft.; "--" indicates tower failure.  
 \*Round antennas include omnis, dipoles, dishes with radomes, etc. Antennas where wind hits a round surface. Flat Antennas include flat panels, dishes without radomes and cameras, where wind hits a flat surface.  
 \*Please contact Tylon directly for more information.

## Common Accessories

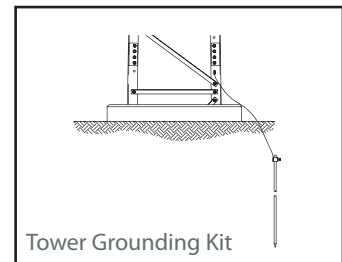
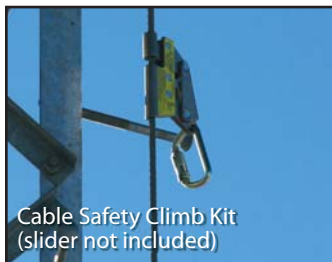

Accessory:	W020	W040	W060	W080	W100	W200	W300
<b>Cable Safety Climb Kits</b> <i>no slider</i>	4.99.0300.000	4.99.0300.000	4.99.0300.000	4.99.0300.000	4.99.0300.000	4.99.0300.000	4.99.0300.000
<b>Lighting Kit</b>	4.942.1024.150	4.942.1024.150	4.942.1024.150	4.942.1024.150	4.942.1024.150	4.942.1024.150	4.942.1024.150
<b>Anti-Climb Shield Kits</b>	4.936.0026.002	4.936.0026.003	4.936.0026.004	4.936.0026.005	4.936.0026.006	4.936.0026.007	4.936.0026.008
<b>Tower Grounding Kit</b> <i>basic, single leg</i>	4.912.1177.100	4.912.1177.125	4.912.1177.150	4.912.1177.175	4.912.1177.175	4.912.1177.175	4.912.1177.225

For more SuperTitan Weld Accessories and Replacement Parts, see pages 61 to 76.

Model Designation:		W400	W500	W600	W700	W800	W900	W1000
Part Number:		5.640.0400.060	5.640.0500.060	5.640.0600.060	5.640.0700.060	5.640.0800.060	5.640.0900.060	5.640.1000.060
Allowable antenna area in ft <sup>2</sup> at:*	EIA Rev.G Class 1 90/105/120 mph wind 3/4" ice	<b>56/32/16</b>	<b>82/50/32</b>	--/--/*	--/--/*	--/--/*	--/--/*	--/--/*
	EIA Rev.G Class 2 90/105/120 mph wind 3/4" ice	<b>46/24/12</b>	<b>66/40/24</b>	--/--/*	--/--/*	--/--/*	--/--/*	--/--/*
Shipping Weight (lbs)		3,727	4,061	4,416	4,812	5,285	5,723	6,100

\*Assumptions: Projected areas (PA) shown are bare; a 1.5 multiplier used for iced area; loads centrally located and balanced at tower top; considers step-pegs, safety cable, and one 1/2" tx line per 10 sq.ft.; "--" indicates tower failure.  
 \*Round antennas include omnis, dipoles, dishes with radomes, etc. Antennas where wind hits a round surface. Flat Antennas include flat panels, dishes without radomes and cameras, where wind hits a flat surface.  
 \*Please contact Trylon directly for more information.

## Common Accessories

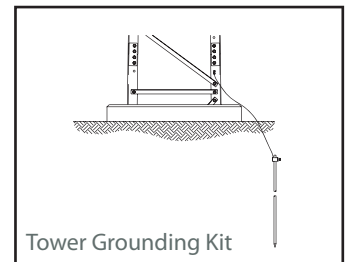
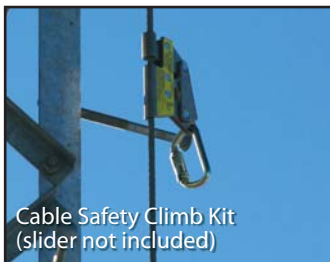

Accessory:	W400	W500	W600	W700	W800	W900	W1000
<b>Cable Safety Climb Kits</b> <i>no slider</i>	4.99.0300.000	4.99.0300.000	4.99.0300.000	4.99.0300.000	4.99.0300.000	4.99.0300.000	4.99.0300.000
<b>Lighting Kit</b>	4.942.1024.150	4.942.1024.150	4.942.1024.150	4.942.1024.150	4.942.1024.150	4.942.1024.150	4.942.1024.150
<b>Anti-Climb Shield Kits</b>	4.936.0026.009	4.936.0026.010	4.936.0026.011	4.936.0026.012	4.936.0026.013	4.936.0026.014	4.936.0026.015
<b>Tower Grounding Kit</b> <i>basic, single leg</i>	4.912.1177.225	4.912.1177.225	4.912.1177.250	4.912.1177.250	4.912.1177.250	4.912.1177.250	4.912.1177.250

For more SuperTitan Weld Accessories and Replacement Parts, see pages 61 to 76.

Model Designation:	W020	W040	W060	W080	W100	W200	W300	
Part Number:	5.640.0020.070	5.640.0040.070	5.640.0060.070	5.640.0080.070	5.640.0100.070	5.640.0200.070	5.640.0300.070	
	 Sec #1 Sec #1 Sec #1 Sec #1 Sec #1 Sec #2 Sec #3	 Sec #1 Sec #1 Sec #1 Sec #1 Sec #2 Sec #3 Sec #4	 Sec #1 Sec #1 Sec #1 Sec #2 Sec #3 Sec #4 Sec #5	 Sec #1 Sec #1 Sec #2 Sec #3 Sec #4 Sec #5 Sec #6	 Sec #1 Sec #2 Sec #3 Sec #4 Sec #5 Sec #6 Sec #7	 Sec #2 Sec #3 Sec #4 Sec #5 Sec #6 Sec #7 Sec #8	 Sec #3 Sec #4 Sec #5 Sec #6 Sec #7 Sec #8 Sec #9	
Allowable antenna area in ft <sup>2</sup> at:*	EIA Rev.G Class 1 90/105/120 mph wind 3/4" ice	--/--*	--/--*	--/--*	--/--*	<b>14/2/-</b>	<b>26/14/4</b>	<b>38/16/4</b>
	EIA Rev.G Class 2 90/105/120 mph wind 3/4" ice	--/--*	--/--*	--/--*	--/--*	<b>8/-/-</b>	<b>20/10/-</b>	<b>28/12/-</b>
Shipping Weight (lbs)	1,985	2,235	2,585	2,927	3,218	3,597	4,044	

\*Assumptions: Projected areas (PA) shown are bare; a 1.5 multiplier used for iced area; loads centrally located and balanced at tower top; considers step-pegs, safety cable, and one 1/2" tx line per 10 sq.ft.; "--" indicates tower failure.  
 \*Round antennas include omnis, dipoles, dishes with radomes, etc. Antennas where wind hits a round surface. Flat Antennas include flat panels, dishes without radomes and cameras, where wind hits a flat surface.  
 \*Please contact Trylon directly for more information.



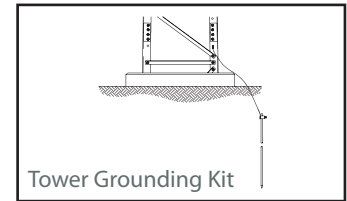



## Common Accessories



Accessory:	W020	W040	W060	W080	W100	W200	W300
<b>Cable Safety Climb Kits</b> <i>no slider</i>	4.99.0300.000	4.99.0300.000	4.99.0300.000	4.99.0300.000	4.99.0300.000	4.99.0300.000	4.99.0300.000
<b>Lighting Kit</b>	4.942.1024.150	4.942.1024.150	4.942.1024.150	4.942.1024.150	4.942.1024.150	4.942.1024.150	4.942.1024.150
<b>Anti-Climb Shield Kits</b>	4.936.0026.003	4.936.0026.004	4.936.0026.005	4.936.0026.006	4.936.0026.007	4.936.0026.008	4.936.0026.009
<b>Tower Grounding Kit</b> <i>basic, single leg</i>	4.912.1177.125	4.912.1177.150	4.912.1177.175	4.912.1177.175	4.912.1177.175	4.912.1177.225	4.912.1177.225

For more SuperTitan Weld Accessories and Replacement Parts, see pages 61 to 76.



Model Designation:		W400	W500	W600	W700	W800	W900
Part Number:		5.640.0400.070	5.640.0500.070	5.640.0600.070	5.640.0700.070	5.640.0800.070	5.640.0900.070
		 Sec #4 Sec #5 Sec #6 Sec #7 Sec #8 Sec #9 Sec #10	 Sec #5 Sec #6 Sec #7 Sec #8 Sec #9 Sec #10 Sec #11	 Sec #6 Sec #7 Sec #8 Sec #9 Sec #10 Sec #11 Sec #12	 Sec #7 Sec #8 Sec #9 Sec #10 Sec #11 Sec #12 Sec #13	 Sec #8 Sec #9 Sec #10 Sec #11 Sec #12 Sec #13 Sec #14	 Sec #9 Sec #10 Sec #11 Sec #12 Sec #13 Sec #14 Sec #15
Allowable antenna area in ft <sup>2</sup> at:*	EIA Rev.G Class 1 90/105/120 mph wind 3/4" ice	<b>52/30/14</b>	<b>78/48/30</b>	<b>88/48/28</b>	--/--/*	--/--/*	--/--/*
	EIA Rev.G Class 2 90/105/120 mph wind 3/4" ice	<b>44/22/10</b>	<b>62/38/20</b>	<b>66/36/16</b>	--/--/*	--/--/*	--/--/*
Shipping Weight (lbs)		4,443	4,874	5,283	5,793	6,320	6,740

\*Assumptions: Projected areas (PA) shown are bare; a 1.5 multiplier used for iced area; loads centrally located and balanced at tower top; considers step-pegs, safety cable, and one 1/2" tx line per 10 sq.ft.; "--" indicates tower failure.  
\*Round antennas include omnis, dipoles, dishes with radomes, etc. Antennas where wind hits a round surface. Flat Antennas include flat panels, dishes without radomes and cameras, where wind hits a flat surface.  
\*Please contact Tylon directly for more information.

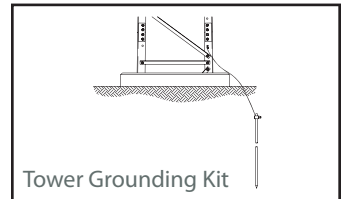
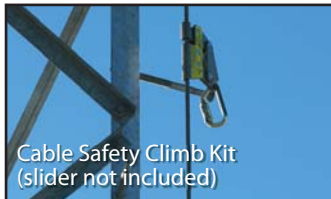

## Common Accessories



Accessory:	W400	W500	W600	W700	W800	W900
<b>Cable Safety Climb Kits</b> <i>no slider</i>	4.99.0300.000	4.99.0300.000	4.99.0300.000	4.99.0300.000	4.99.0300.000	4.99.0300.000
<b>Lighting Kit</b>	4.942.1024.150	4.942.1024.150	4.942.1024.150	4.942.1024.150	4.942.1024.150	4.942.1024.150
<b>Anti-Climb Shield Kits</b>	4.936.0026.010	4.936.0026.011	4.936.0026.012	4.936.0026.013	4.936.0026.014	4.936.0026.015
<b>Tower Grounding Kit</b> <i>basic, single leg</i>	4.912.1177.225	4.912.1177.250	4.912.1177.250	4.912.1177.250	4.912.1177.250	4.912.1177.250

For more SuperTitan Weld Accessories and Replacement Parts, see pages 61 to 76.

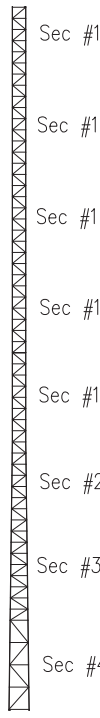
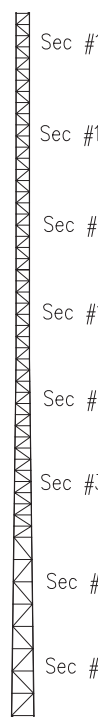
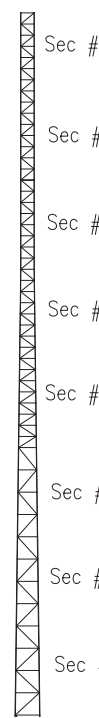
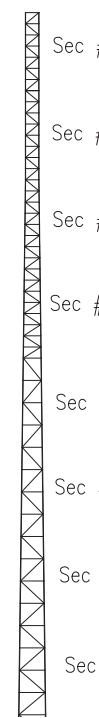
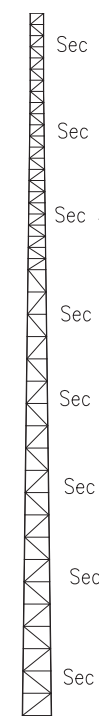
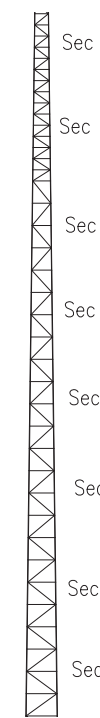





Model Designation:		W020	W040	W060	W080	W100	W200	W300
Part Number:		5.640.0020.080	5.640.0040.080	5.640.0060.080	5.640.0080.080	5.640.0100.080	5.640.0200.080	5.640.0300.080
								
Allowable antenna area in ft <sup>2</sup> at:*								
EIA Rev.G Class 1 90/105/120 mph wind 3/4" ice		--/--/*	--/--/*	--/--/*	--/--/*	<b>12/2/-</b>	<b>22/6/-</b>	<b>34/14/2</b>
EIA Rev.G Class 2 90/105/120 mph wind 3/4" ice		--/--/*	--/--/*	--/--/*	--/--/*	<b>6/-/-</b>	<b>14/-/-</b>	<b>26/10/-</b>
Shipping Weight (lbs)		2,520	2,795	3,155	3,438	3,816	4,255	4,760

\*Assumptions: Projected areas (PA) shown are bare; a 1.5 multiplier used for iced area; loads centrally located and balanced at tower top; considers step-pegs, safety cable, and one 1/2" tx line per 10 sq.ft.; "--" indicates tower failure.  
 \*Round antennas include omnis, dipoles, dishes with radomes, etc. Antennas where wind hits a round surface. Flat Antennas include flat panels, dishes without radomes and cameras, where wind hits a flat surface.  
 \*Please contact Trylon directly for more information.

## Common Accessories

Accessory:	W020	W040	W060	W080	W100	W200	W300
<b>Cable Safety Climb Kits</b> <i>no slider</i>	4.99.0300.000	4.99.0300.000	4.99.0300.000	4.99.0300.000	4.99.0300.000	4.99.0300.000	4.99.0300.000
<b>Lighting Kit</b>	4.942.1024.150	4.942.1024.150	4.942.1024.150	4.942.1024.150	4.942.1024.150	4.942.1024.150	4.942.1024.150
<b>Anti-Climb Shield Kits</b>	4.936.0026.004	4.936.0026.005	4.936.0026.006	4.936.0026.007	4.936.0026.008	4.936.0026.009	4.936.0026.010
<b>Tower Grounding Kit</b> <i>basic, single leg</i>	4.912.1177.150	4.912.1177.175	4.912.1177.175	4.912.1177.175	4.912.1177.225	4.912.1177.225	4.912.1177.225

For more SuperTitan Weld Accessories and Replacement Parts, see pages 61 to 76.

Model Designation:		W400	W500	W600	W700	W800		
Part Number:		5.640.0400.080	5.640.0500.080	5.640.0600.080	5.640.0700.080	5.640.0800.080		
		 Sec #4 Sec #5 Sec #6 Sec #7 Sec #8 Sec #9 Sec #10 Sec #11	 Sec #5 Sec #6 Sec #7 Sec #8 Sec #9 Sec #10 Sec #11 Sec #12	 Sec #6 Sec #7 Sec #8 Sec #9 Sec #10 Sec #11 Sec #12 Sec #13	 Sec #7 Sec #8 Sec #9 Sec #10 Sec #11 Sec #12 Sec #13 Sec #14	 Sec #8 Sec #9 Sec #10 Sec #11 Sec #12 Sec #13 Sec #14 Sec #15		
Allowable antenna area in ft <sup>2</sup> at:*	EIA Rev.G Class 1 90/105/120 mph wind 3/4" ice	<b>132/78/48</b>	<b>134/86/50</b>	<b>136/88/52</b>	<b>180/102/54</b>	<b>--/--*</b>		
	EIA Rev.G Class 2 90/105/120 mph wind 3/4" ice	<b>112/64/38</b>	<b>115/72/40</b>	<b>118/74/42</b>	<b>150/80/44</b>	<b>--/--*</b>		
Shipping Weight (lbs)		5,257	5,742	6,265	6,828	7,336		

\*Assumptions: Projected areas (PA) shown are bare; a 1.5 multiplier used for iced area; loads centrally located and balanced at tower top; considers step-pegs, safety cable, and one 1/2" tx line per 10 sq.ft.; "--" indicates tower failure.  
 \*Round antennas include omnis, dipoles, dishes with radomes, etc. Antennas where wind hits a round surface. Flat Antennas include flat panels, dishes without radomes and cameras, where wind hits a flat surface.  
 \*Please contact Trylon directly for more information.

## Common Accessories

Accessory:	W400	W500	W600	W700	W800		
<b>Cable Safety Climb Kits</b> <i>no slider</i>	4.99.0300.000	4.99.0300.000	4.99.0300.000	4.99.0300.000	4.99.0300.000		
<b>Lighting Kit</b>	4.942.1024.150	4.942.1024.150	4.942.1024.150	4.942.1024.150	4.942.1024.150		
<b>Anti-Climb Shield Kits</b>	4.936.0026.011	4.936.0026.012	4.936.0026.013	4.936.0026.014	4.936.0026.015		
<b>Tower Grounding Kit</b> <i>basic, single leg</i>	4.912.1177.250	4.912.1177.250	4.912.1177.250	4.912.1177.250	4.912.1177.250		

For more SuperTitan Weld Accessories and Replacement Parts, see pages 61 to 76.





Model Designation:		W020	W040	W060	W080	W100	W200	W300
Part Number:		5.640.0020.090	5.640.0040.090	5.640.0060.090	5.640.0080.090	5.640.0100.090	5.640.0200.090	5.640.0300.090
Allowable antenna area in ft <sup>2</sup> *	EIA Rev.G Class 1 90/105/120 mph wind 3/4" ice	--/--/*	--/--/*	--/--/*	--/--/*	<b>60/36/22</b>	<b>80/46/30</b>	<b>104/56/36</b>
	EIA Rev.G Class 2 90/105/120 mph wind 3/4" ice	--/--/*	--/--/*	--/--/*	--/--/*	<b>52/30/16</b>	<b>66/40/22</b>	<b>86/48/30</b>
Shipping Weight (lbs)		3,202	3,485	3,710	4,036	4,474	4,971	5,573

\*Assumptions: Projected areas (PA) shown are bare; a 1.5 multiplier used for iced area; loads centrally located and balanced at tower top; considers step-pegs, safety cable, and one 1/2" tx line per 10 sq.ft.; "--" indicates tower failure.  
 \*\*Round antennas include omnis, dipoles, dishes with radomes, etc. Antennas where wind hits a round surface. Flat Antennas include flat panels, dishes without radomes and cameras, where wind hits a flat surface.  
 \*Please contact Tylon directly for more information.

## Common Accessories

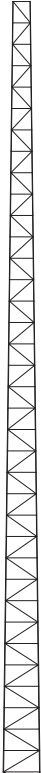
Accessory:	W020	W040	W060	W080	W100	W200	W300
<b>Cable Safety Climb Kits</b> <i>no slider</i>	4.99.0300.000	4.99.0300.000	4.99.0300.000	4.99.0300.000	4.99.0300.000	4.99.0300.000	4.99.0300.000
<b>Lighting Kit</b>	4.942.1024.150	4.942.1024.150	4.942.1024.150	4.942.1024.150	4.942.1024.150	4.942.1024.150	4.942.1024.150
<b>Anti-Climb Shield Kits</b>	4.936.0026.005	4.936.0026.006	4.936.0026.007	4.936.0026.008	4.936.0026.009	4.936.0026.010	4.936.0026.011
<b>Tower Grounding Kit</b> <i>basic, single leg</i>	4.912.1177.175	4.912.1177.175	4.912.1177.175	4.912.1177.225	4.912.1177.225	4.912.1177.225	4.912.1177.250

For more SuperTitan Weld Accessories and Replacement Parts, see pages 61 to 76.

Model Designation:		W400	W500	W600	W700			
Part Number:		5.640.0400.090	5.640.0500.090	5.640.0600.090	5.640.0700.090			
		 Sec #4 Sec #5 Sec #6 Sec #7 Sec #8 Sec #9 Sec #10 Sec #11 Sec #12	 Sec #5 Sec #6 Sec #7 Sec #8 Sec #9 Sec #10 Sec #11 Sec #12 Sec #13	 Sec #6 Sec #7 Sec #8 Sec #9 Sec #10 Sec #11 Sec #12 Sec #13 Sec #14	 Sec #7 Sec #8 Sec #9 Sec #10 Sec #11 Sec #12 Sec #13 Sec #14 Sec #15			
Allowable antenna area in ft <sup>2</sup> *	EIA Rev.G Class 1 90/105/120 mph wind 3/4" ice	<b>130/74/46</b>	<b>132/84/48</b>	<b>134/86/50</b>	<b>182/98/52</b>			
	EIA Rev.G Class 2 90/105/120 mph wind 3/4" ice	<b>108/60/40</b>	<b>111/70/42</b>	<b>114/72/44</b>	<b>148/76/46</b>			
Shipping Weight (lbs)		6,124	6,724	7,300	7,845			

\*Assumptions: Projected areas (PA) shown are bare; a 1.5 multiplier used for iced area; loads centrally located and balanced at tower top; considers step-pegs, safety cable, and one 1/2" x line per 10 sq.ft.; "-" indicates tower failure.  
 \*Round antennas include omnis, dipoles, dishes with radomes, etc. Antennas where wind hits a round surface. Flat Antennas include flat panels, dishes without radomes and cameras, where wind hits a flat surface.  
 \*Please contact Trylon directly for more information.

## Common Accessories

Accessory:	W400	W500	W600	W700			
<b>Cable Safety Climb Kits</b> <i>no slider</i>	4.99.0300.000	4.99.0300.000	4.99.0300.000	4.99.0300.000			
<b>Lighting Kit</b>	4.942.1024.150	4.942.1024.150	4.942.1024.150	4.942.1024.150			
<b>Anti-Climb Shield Kits</b>	4.936.0026.012	4.936.0026.013	4.936.0026.014	4.936.0026.015			
<b>Tower Grounding Kit</b> <i>basic, single leg</i>	4.912.1177.250	4.912.1177.250	4.912.1177.250	4.912.1177.250			

For more SuperTitan Weld Accessories and Replacement Parts, see pages 61 to 76.

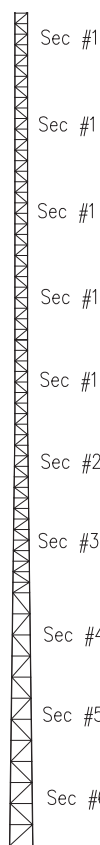
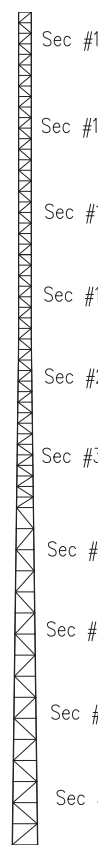
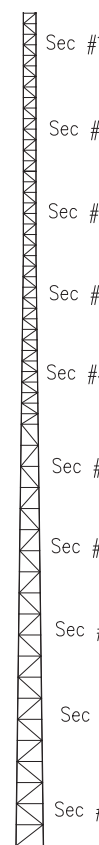
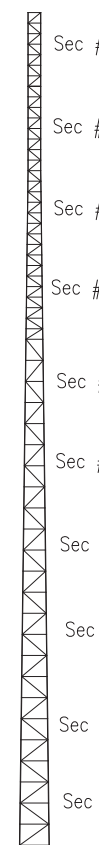
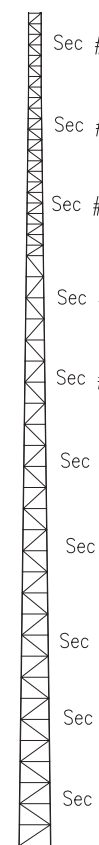
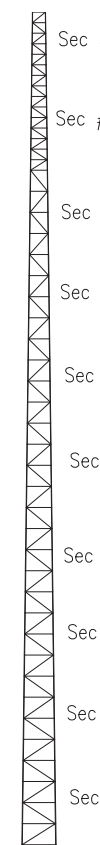
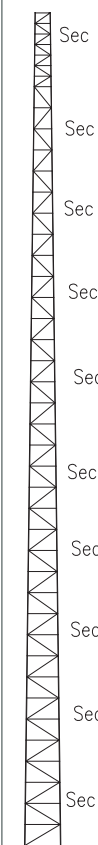

Model Designation:		W020	W040	W060	W080	W100	W200	W300
Part Number:		5.640.0020.100	5.640.0040.100	5.640.0060.100	5.640.0080.100	5.640.0100.100	5.640.0200.100	5.640.0300.100
								
Allowable antenna area in ft <sup>2</sup> *	EIA Rev.G Class 1 90/105/120 mph wind 3/4" ice	--/--*	--/--*	--/--*	--/--*	<b>58/34/20</b>	<b>78/46/28</b>	<b>100/54/34</b>
	EIA Rev.G Class 2 90/105/120 mph wind 3/4" ice	--/--*	--/--*	--/--*	--/--*	<b>50/30/14</b>	<b>64/38/20</b>	<b>82/46/30</b>
Shipping Weight (lbs)		3,795	4,035	4,315	4,694	5,190	5,784	6,440

\*Assumptions: Projected areas (PA) shown are bare; a 1.5 multiplier used for iced area; loads centrally located and balanced at tower top; considers step-pegs, safety cable, and one 1/2" tx line per 10 sq.ft.; "-" indicates tower failure.  
 \*Round antennas include omnis, dipoles, dishes with radomes, etc. Antennas where wind hits a round surface. Flat Antennas include flat panels, dishes without radomes and cameras, where wind hits a flat surface.  
 \*Please contact Tylon directly for more information.

## Common Accessories

Accessory:	W020	W040	W060	W080	W100	W200	W300
<b>Cable Safety Climb Kits</b> <i>no slider</i>	4.99.0300.000	4.99.0300.000	4.99.0300.000	4.99.0300.000	4.99.0300.000	4.99.0300.000	4.99.0300.000
<b>Lighting Kit</b>	4.942.1024.150	4.942.1024.150	4.942.1024.150	4.942.1024.150	4.942.1024.150	4.942.1024.150	4.942.1024.150
<b>Anti-Climb Shield Kits</b>	4.936.0026.006	4.936.0026.007	4.936.0026.008	4.936.0026.009	4.936.0026.010	4.936.0026.011	4.936.0026.012
<b>Tower Grounding Kit</b> <i>basic, single leg</i>	4.912.1177.175	4.912.1177.175	4.912.1177.225	4.912.1177.225	4.912.1177.225	4.912.1177.250	4.912.1177.250

For more SuperTitan Weld Accessories and Replacement Parts, see pages 61 to 76.

Model Designation:		W400	W500	W600				
Part Number:		5.640.0400.100	5.640.0500.100	5.640.0600.100				
		 Sec #4 Sec #5 Sec #6 Sec #7 Sec #8 Sec #9 Sec #10 Sec #11 Sec #12 Sec #13	 Sec #5 Sec #6 Sec #7 Sec #8 Sec #9 Sec #10 Sec #11 Sec #12 Sec #13 Sec #14	 Sec #6 Sec #7 Sec #8 Sec #9 Sec #10 Sec #11 Sec #12 Sec #13 Sec #14 Sec #15				
Allowable antenna area in ft <sup>2</sup> *	EIA Rev.G Class 1 90/105/120 mph wind 3/4" ice	<b>126/72/46</b>	<b>128/82/48</b>	<b>130/84/50</b>				
	EIA Rev.G Class 2 90/105/120 mph wind 3/4" ice	<b>104/58/36</b>	<b>110/68/38</b>	<b>112/70/40</b>				
Shipping Weight (lbs)		7,106	7,758	8,317				





\*Assumptions: Projected areas (PA) shown are bare; a 1.5 multiplier used for iced area; loads centrally located and balanced at tower top; considers step-pegs, safety cable, and one 1/2" tx line per 10 sq.ft.; "-" indicates tower failure.  
 \*Round antennas include omnis, dipoles, dishes with radomes, etc. Antennas where wind hits a round surface. Flat Antennas include flat panels, dishes without radomes and cameras, where wind hits a flat surface.  
 \*Please contact Trylon directly for more information.

## Common Accessories

Accessory:	W400	W500	W600				
<b>Cable Safety Climb Kits</b> <i>no slider</i>	4.99.0300.000	4.99.0300.000	4.99.0300.000				
<b>Lighting Kit</b>	4.942.1024.150	4.942.1024.150	4.942.1024.150				
<b>Anti-Climb Shield Kits</b>	4.936.0026.013	4.936.0026.014	4.936.0026.015				
<b>Tower Grounding Kit</b> <i>basic, single leg</i>	4.912.1177.250	4.912.1177.250	4.912.1177.250				

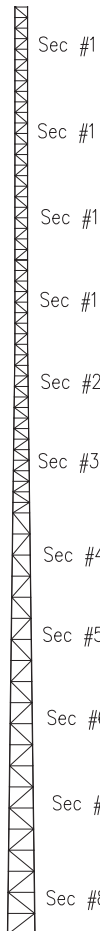
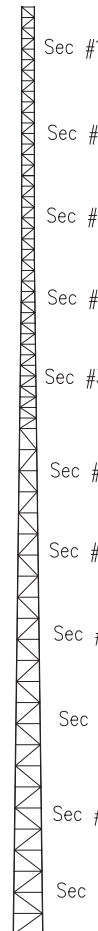
For more SuperTitan Weld Accessories and Replacement Parts, see pages 61 to 76.

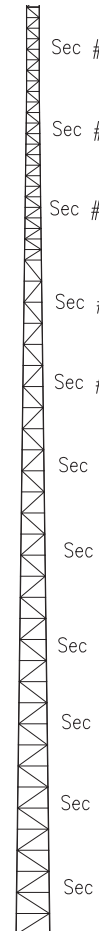
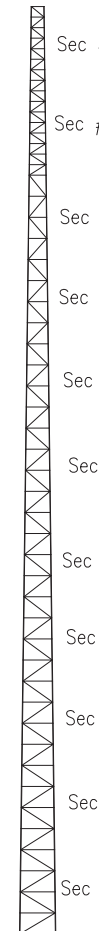
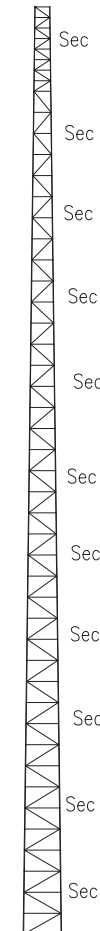

Model Designation:		W040	W060	W080	W100	W200	W300	W400
Part Number:		5.640.0040.110	5.640.0060.110	5.640.0080.110	5.640.0100.110	5.640.0200.110	5.640.0300.110	5.640.0400.110
								
		Sec #1 Sec #1 Sec #1 Sec #1 Sec #2 Sec #3 Sec #4 Sec #5 Sec #6 Sec #7 Sec #8	Sec #1 Sec #1 Sec #1 Sec #2 Sec #3 Sec #4 Sec #5 Sec #6 Sec #7 Sec #8 Sec #9	Sec #1 Sec #1 Sec #2 Sec #3 Sec #4 Sec #5 Sec #6 Sec #7 Sec #8 Sec #9 Sec #10	Sec #1 Sec #2 Sec #3 Sec #4 Sec #5 Sec #6 Sec #7 Sec #8 Sec #9 Sec #10 Sec #11	Sec #2 Sec #3 Sec #4 Sec #5 Sec #6 Sec #7 Sec #8 Sec #9 Sec #10 Sec #11 Sec #12	Sec #3 Sec #4 Sec #5 Sec #6 Sec #7 Sec #8 Sec #9 Sec #10 Sec #11 Sec #12 Sec #13	Sec #4 Sec #5 Sec #6 Sec #7 Sec #8 Sec #9 Sec #10 Sec #11 Sec #12 Sec #13 Sec #14
Allowable antenna area in ft <sup>2</sup> *	EIA Rev.G Class 1 90/105/120 mph wind 3/4" ice	--/--/*	--/--/*	--/--/*	<b>56/34/18</b>	<b>76/46/26</b>	<b>98/52/32</b>	<b>122/70/44</b>
	EIA Rev.G Class 2 90/105/120 mph wind 3/4" ice	--/--/*	--/--/*	--/--/*	<b>48/28/14</b>	<b>62/36/20</b>	<b>80/46/28</b>	<b>102/56/32</b>
Shipping Weight (lbs)		5,085	5,409	6,003	6,651	7,422	8,140	8,140

\*Assumptions: Projected areas (PA) shown are bare; a 1.5 multiplier used for iced area; loads centrally located and balanced at tower top; considers step-pegs, safety cable, and one 1/2" tx line per 10 sq.ft.; "--" indicates tower failure.  
 \*\*Round antennas include omnis, dipoles, dishes with radomes, etc. Antennas where wind hits a round surface. Flat Antennas include flat panels, dishes without radomes and cameras, where wind hits a flat surface.  
 \*\*\*Please contact Tylon directly for more information.

## Common Accessories

Accessory:	W040	W060	W080	W100	W200	W300	W400
<b>Cable Safety Climb Kits</b> <i>no slider</i>	4.99.0305.000	4.99.0305.000	4.99.0305.000	4.99.0305.000	4.99.0305.000	4.99.0305.000	4.99.0305.000
<b>Lighting Kit</b>	4.942.1024.150	4.942.1024.150	4.942.1024.150	4.942.1024.150	4.942.1024.150	4.942.1024.150	4.942.1024.150
<b>Anti-Climb Shield Kits</b>	4.936.0026.008	4.936.0026.009	4.936.0026.010	4.936.0026.011	4.936.0026.012	4.936.0026.013	4.936.0026.014

For more SuperTitan Weld Accessories and Replacement Parts, see pages 61 to 76.

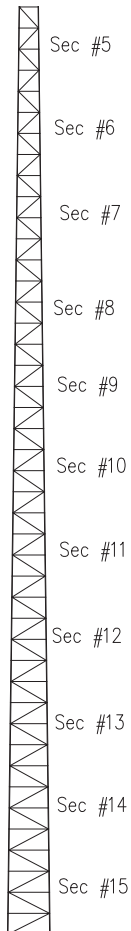





Model Designation:		W500					
Part Number:		5.640.0500.110					
							
Allowable antenna area in ft <sup>2</sup> *	EIA Rev.G Class 1 90/105/120 mph wind 3/4" ice	<b>130/80/46</b>					
	EIA Rev.G Class 2 90/105/120 mph wind 3/4" ice	<b>110/66/34</b>					
Shipping Weight (lbs)		8,775					

\*Assumptions: Projected areas (PA) shown are bare; a 1.5 multiplier used for iced area; loads centrally located and balanced at tower top; considers step-pegs, safety cable, and one 1/2" tx line per 10 sq.ft.; "--" indicates tower failure.  
 \*Round antennas include omnis, dipoles, dishes with radomes, etc. Antennas where wind hits a round surface. Flat Antennas include flat panels, dishes without radomes and cameras, where wind hits a flat surface.  
 \*Please contact Trylon directly for more information.

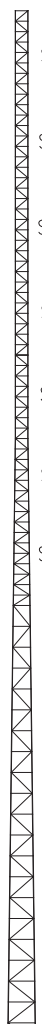
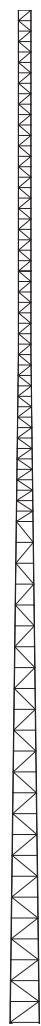
## Common Accessories

Accessory:	W500						
<b>Cable Safety Climb Kits</b> <i>no slider</i>	4.99.0305.000						
<b>Lighting Kit</b>	4.942.1024.150						
<b>Anti-Climb Shield Kits</b>	4.936.0026.015						

For more SuperTitan Weld Accessories and Replacement Parts, see pages 61 to 76.

Model Designation:		W020	W040	W060	W080	W100	W200	W300
Part Number:		5.640.0020.120	5.640.0040.120	5.640.0060.120	5.640.0080.120	5.640.0100.120	5.640.0200.120	5.640.0300.120
		 Sec #1 Sec #1 Sec #1 Sec #1 Sec #1 Sec #2 Sec #3 Sec #4 Sec #5 Sec #6 Sec #7 Sec #8	 Sec #1 Sec #1 Sec #1 Sec #1 Sec #2 Sec #3 Sec #4 Sec #5 Sec #6 Sec #7 Sec #8 Sec #9	 Sec #1 Sec #1 Sec #1 Sec #2 Sec #3 Sec #4 Sec #5 Sec #6 Sec #7 Sec #8 Sec #9 Sec #10	 Sec #1 Sec #1 Sec #2 Sec #3 Sec #4 Sec #5 Sec #6 Sec #7 Sec #8 Sec #9 Sec #10 Sec #11	 Sec #1 Sec #2 Sec #3 Sec #4 Sec #5 Sec #6 Sec #7 Sec #8 Sec #9 Sec #10 Sec #11 Sec #12	 Sec #2 Sec #3 Sec #4 Sec #5 Sec #6 Sec #7 Sec #8 Sec #9 Sec #10 Sec #11 Sec #12 Sec #13	 Sec #3 Sec #4 Sec #5 Sec #6 Sec #7 Sec #8 Sec #9 Sec #10 Sec #11 Sec #12 Sec #13 Sec #14
Allowable antenna area in ft <sup>2</sup> *	EIA Rev.G Class 1 90/105/120 mph wind 3/4" ice	--/--*	--/--*	--/--*	--/--*	<b>54/32/18</b>	<b>74/44/26</b>	<b>94/52/32</b>
	EIA Rev.G Class 2 90/105/120 mph wind 3/4" ice	--/--*	--/--*	--/--*	--/--*	<b>46/28/14</b>	<b>60/34/18</b>	<b>78/46/26</b>
Shipping Weight (lbs)		4732	5,420	5,795	6,223	6,871	7,633	8,457

\*Assumptions: Projected areas (PA) shown are bare; a 1.5 multiplier used for iced area; loads centrally located and balanced at tower top; considers step-pegs, safety cable, and one 1/2" tx line per 10 sq.ft.; "-" indicates tower failure.  
 \*\*Round antennas include omnis, dipoles, dishes with radomes, etc. Antennas where wind hits a round surface. Flat Antennas include flat panels, dishes without radomes and cameras, where wind hits a flat surface.  
 \*\*\*Please contact Trylon directly for more information.

## Common Accessories

Accessory	S100	H100	H110	S300	S310	S400	S410
<b>Cable Safety Climb Kits</b> <i>no slider</i>	4.99.0305.000	4.99.0305.000	4.99.0305.000	4.99.0305.000	4.99.0305.000	4.99.0305.000	4.99.0305.000
<b>Lighting Kit</b>	4.942.1024.150	4.942.1024.150	4.942.1024.150	4.942.1024.150	4.942.1024.150	4.942.1024.150	4.942.1024.150

For more SuperTitan Weld Accessories and Replacement Parts, see pages 61 to 76.

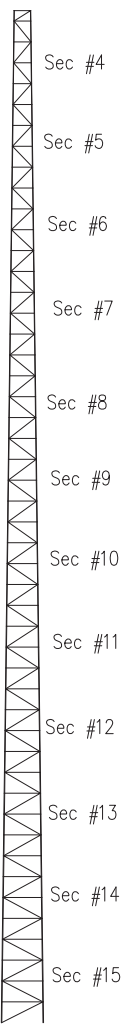
Model Designation:		W400					
Part Number:		5.640.0400.120					
							
Allowable antenna area in ft <sup>2</sup> *	EIA Rev.G Class 1 90/105/120 mph wind 3/4" ice	<b>120/68/44</b>					
	EIA Rev.G Class 2 90/105/120 mph wind 3/4" ice	<b>98/54/30</b>					
Shipping Weight (lbs)		9,157					

\*Assumptions: Projected areas (PA) shown are bare; a 1.5 multiplier used for iced area; loads centrally located and balanced at tower top; considers step-pegs, safety cable, and one 1/2" tx line per 10 sq.ft.; "-" indicates tower failure.  
\*Round antennas include omnis, dipoles, dishes with radomes, etc. Antennas where wind hits a round surface. Flat Antennas include flat panels, dishes without radomes and cameras, where wind hits a flat surface.  
\*Please contact Trylon directly for more information.

## Common Accessories

Accessory	S500					
<b>Cable Safety Climb Kits</b> <small>no slider</small>	4.99.0305.000					
<b>Lighting Kit</b>	4.942.1024.150					

For more SuperTitan Weld Accessories and Replacement Parts, see pages 61 to 76.

Model Designation:		W020	W040	W060	W080	W100	W200	W300
Part Number:		5.640.0020.130	5.640.0040.130	5.640.0060.130	5.640.0080.130	5.640.0100.130	5.640.0200.130	5.640.0300.130
Allowable antenna area in ft <sup>2</sup> *	EIA Rev.G Class 1 90/105/120 mph wind 3/4" ice	--/--/*	--/--/*	--/--/*	--/--/*	<b>54/30/16</b>	<b>72/42/24</b>	<b>92/52/30</b>
	EIA Rev.G Class 2 90/105/120 mph wind 3/4" ice	--/--/*	--/--/*	--/--/*	--/--/*	<b>46/26/14</b>	<b>58/32/16</b>	<b>74/44/26</b>
Shipping Weight (lbs)		5390	5886	6,650	7,090	7,853	8,668	9,474

\*Assumptions: Projected areas (PA) shown are bare; a 1.5 multiplier used for iced area; loads centrally located and balanced at tower top; considers step-pegs, safety cable, and one 1/2" tx line per 10 sq.ft.; "--" indicates tower failure.  
 \*Round antennas include omnis, dipoles, dishes with radomes, etc. Antennas where wind hits a round surface. Flat Antennas include flat panels, dishes without radomes and cameras, where wind hits a flat surface.  
 \*Please contact Trylon directly for more information.

## Common Accessories

Accessory	S300	S310	S400	S410	S500	S510	S600
<b>Cable Safety Climb Kits</b> <i>no slider</i>	4.99.0305.000	4.99.0305.000	4.99.0305.000	4.99.0305.000	4.99.0305.000	4.99.0305.000	4.99.0305.000
<b>Lighting Kit</b>	4.942.1024.150	4.942.1024.150	4.942.1024.150	4.942.1024.150	4.942.1024.150	4.942.1024.150	4.942.1024.150

For more SuperTitan Weld Accessories and Replacement Parts, see pages 61 to 76.

# 140' Towers

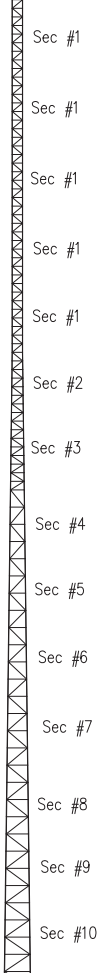
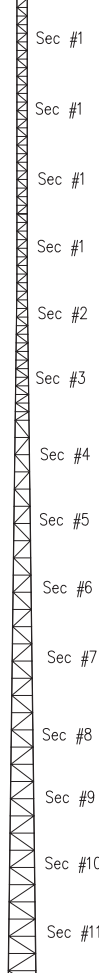
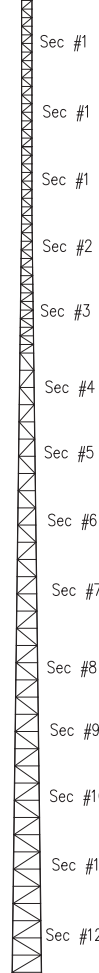
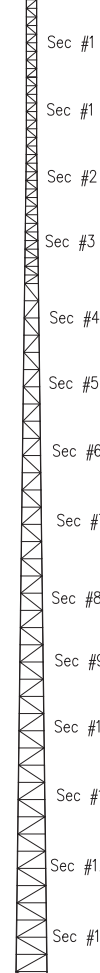
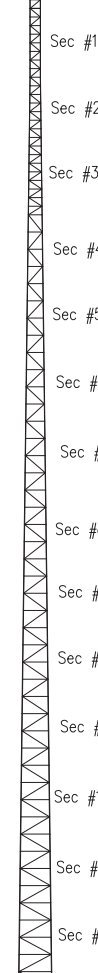
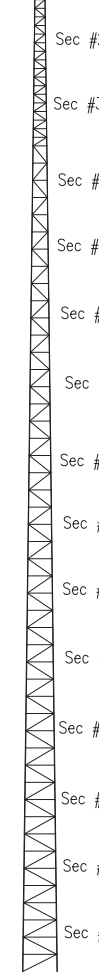

Model Designation:		W020	W040	W060	W080	W100	W200
Part Number:		5.640.0020.140	5.640.0040.140	5.640.0060.140	5.640.0080.140	5.640.0100.140	5.640.0200.140
							
Allowable antenna area in ft <sup>2</sup> *		EIA Rev.G Class 1 90/105/120 mph wind 3/4" ice --/--/--*	--/--/--*	--/--/--*	--/--/--*	<b>52/30/16</b>	<b>70/42/24</b>
		EIA Rev.G Class 2 90/105/120 mph wind 3/4" ice --/--/--*	--/--/--*	--/--/--*	--/--/--*	<b>46/26/14</b>	<b>56/32/16</b>
Shipping Weight (lbs)		6106	6700	7,595	8,072	8,887	9,685

\*Assumptions: Projected areas (PA) shown are bare; a 1.5 multiplier used for iced area; loads centrally located and balanced at tower top; considers step-pegs, safety cable, and one 1/2" tx line per 10 sq.ft.; "--" indicates tower failure.  
 \*Round antennas include omnis, dipoles, dishes with radomes, etc. Antennas where wind hits a round surface. Flat Antennas include flat panels, dishes without radomes and cameras, where wind hits a flat surface.  
 \*Please contact Tylon directly for more information.

## Common Accessories

Accessory	S300	S310	S400	S410	S500	S510
<b>Cable Safety Climb Kits</b> <i>no slider</i>	4.99.0305.000	4.99.0305.000	4.99.0305.000	4.99.0305.000	4.99.0305.000	4.99.0305.000
<b>Lighting Kit</b>	4.942.1024.150	4.942.1024.150	4.942.1024.150	4.942.1024.150	4.942.1024.150	4.942.1024.150

For more SuperTitan Weld Accessories and Replacement Parts, see pages 61 to 76.





Model Designation:		W060	W080	W100			
Part Number:		5.640.0060.150	5.640.0080.150	5.640.0100.150			
Allowable antenna area in ft <sup>2</sup> *	EIA Rev.G Class 1 90/105/120 mph wind 3/4" ice	--/--*	--/--*	<b>52/30/14</b>			
	EIA Rev.G Class 2 90/105/120 mph wind 3/4" ice	--/--*	--/--*	<b>46/26/12</b>			
Shipping Weight (lbs)		8,580	9,106	9,904			

Cable Safety Climb Kit – pg 67 (slider not included)

Step-Bolt Kit – pg 59

\*Assumptions: Projected areas (PA) shown are bare; a 1.5 multiplier used for iced area; loads centrally located and balanced at tower top; considers step-pegs, safety cable, and one 1/2" tx line per 10 sq.ft.; "--" indicates tower failure.  
 \*Round antennas include omnis, dipoles, dishes with radomes, etc. Antennas where wind hits a round surface. Flat Antennas include flat panels, dishes without radomes and cameras, where wind hits a flat surface.  
 \*Please contact Tylon directly for more information.

## Common Accessories

Accessory	W060	W080	W100			
<b>Lighting Kit</b>	4.942.1024.150	4.942.1024.150	4.942.1024.150			

For more SuperTitan Weld Accessories and Replacement Parts, see pages 61 to 76.

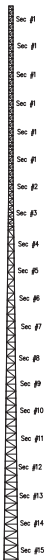
SuperTitan Weld Sections			
Part #	Description	Weight	Image
4.640.0001.000	SuperTitan Weld Section #1: Non-Tapered	220	
4.640.0002.000	SuperTitan Weld Section #2: Tapered	212	
4.640.0003.000	SuperTitan Weld Section #3: Tapered	317	
4.640.0004.000	SuperTitan Weld Section #4: Tapered	383	
4.640.0005.000	SuperTitan Weld Section #5: Tapered	459	
4.640.0006.000	SuperTitan Weld Section #6: Tapered	472	
4.640.0007.000	SuperTitan Weld Section #7: Tapered	509	
4.640.0008.000	SuperTitan Weld Section #8: Tapered	597	
4.640.0009.000	SuperTitan Weld Section #9: Tapered	640	
4.640.0010.000	SuperTitan Weld Section #10: Tapered	714	
4.640.0011.000	SuperTitan Weld Section #11: Tapered	812	
4.640.0012.000	SuperTitan Weld Section #12: Tapered	866	
4.640.0013.000	SuperTitan Weld Section #13: Tapered	981	
4.640.0014.000	SuperTitan Weld Section #14: Tapered	1033	
4.640.0015.000	SuperTitan Weld Section #15: Tapered	1054	

SuperTitan Weld Sections		
Part #	Description	Weight
4.640.0000.002	Template & Tie Rods fits Section #1	450
4.640.0000.003	Template & Tie Rods fits Section #2	452
4.640.0000.004	Template & Tie Rods fits Section #3	557
4.640.0000.005	Template & Tie Rods fits Section #4	558
4.640.0000.006	Template & Tie Rods fits Section #5	560
4.640.0000.007	Template & Tie Rods fits Section #6	667
4.640.0000.008	Template & Tie Rods fits Section #7	669
4.640.0000.009	Template & Tie Rods fits Section #8	671
4.640.0000.010	Template & Tie Rods fits Section #9	689
4.640.0000.011	Template & Tie Rods fits Section #10	690
4.640.0000.012	Template & Tie Rods fits Section #11	692
4.640.0000.013	Template & Tie Rods fits Section #12	694
4.640.0000.014	Template & Tie Rods fits Section #13	696
4.640.0000.015	Template & Tie Rods fits Section #14	698
4.640.0000.016	Template & Tie Rods fits Section #15	700



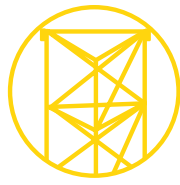
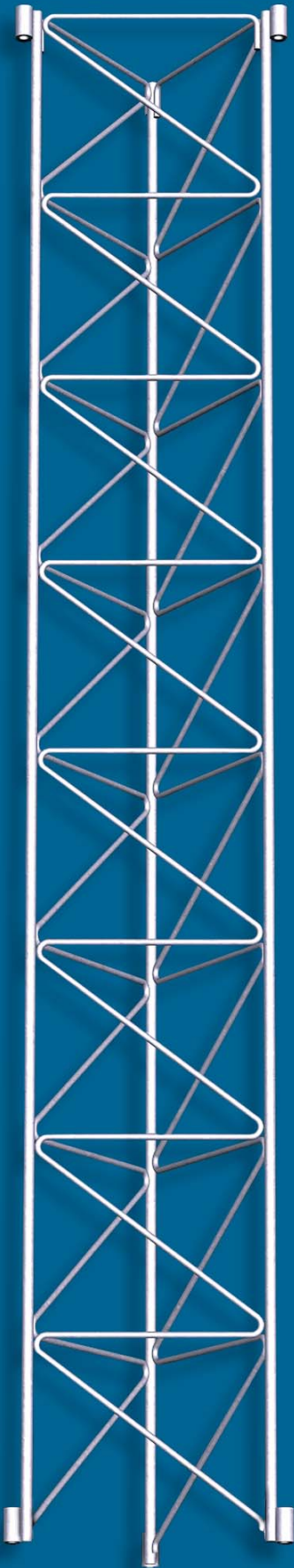

# STG SERIES

A stronger, cost-effective alternative to 45/55/65G series

- .. TIA/EIA 222 F and G compliant
- .. Just one Tylon section replaces all three Rohn – 45/55/65G!
- .. Solid rod legs, not hollow tubes
  - ... More durable during transit
  - ... Eliminates internal leg corrosion
- .. External splice spigots for easy installation
- .. Guyed to 480' tall
- .. Bracketed to 120'
- .. Free-standing to 70'

# SuperTITAN Guyed™ vs. Rohn Guyed

A stronger, cost-effective alternative to 45/55/65G series

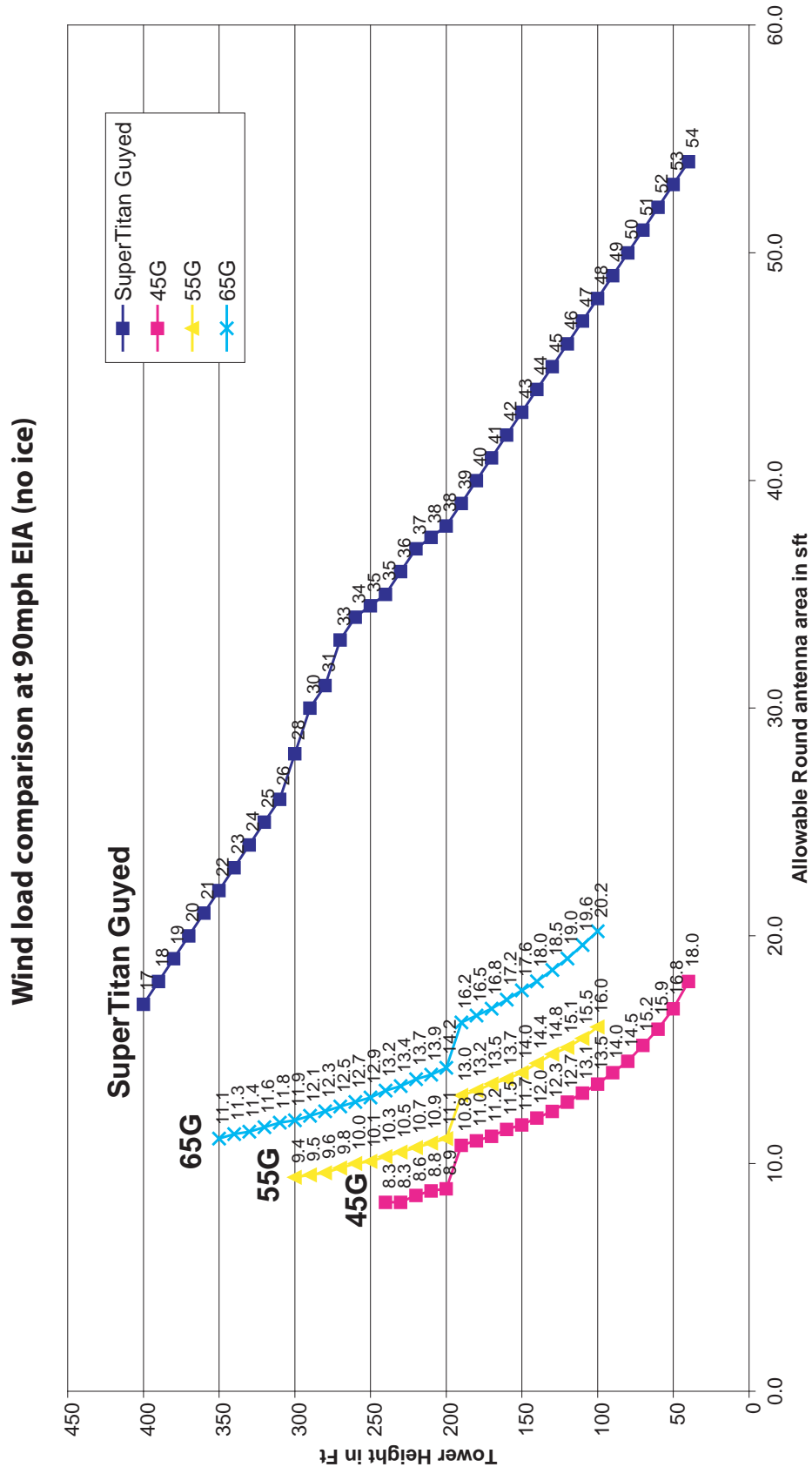

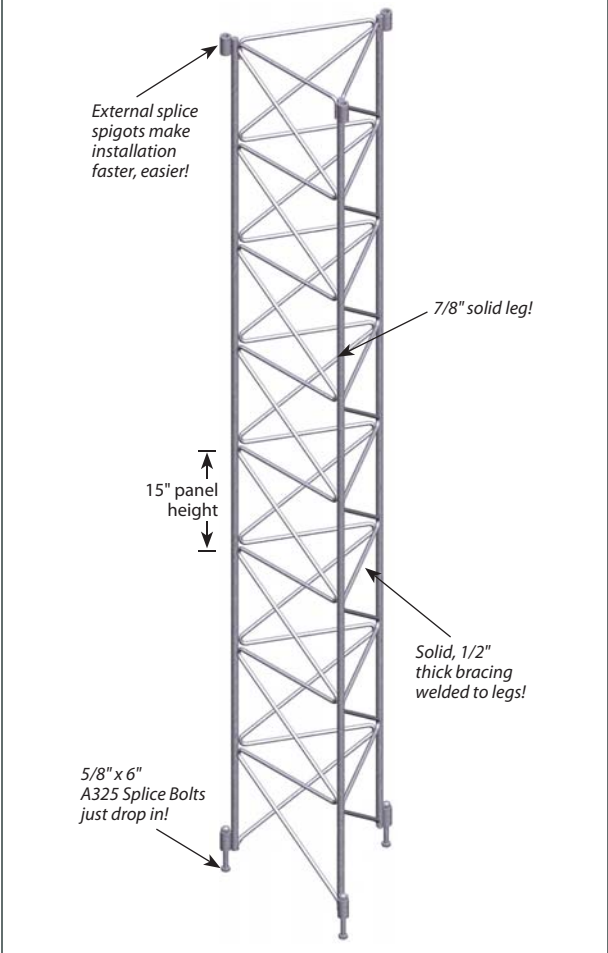
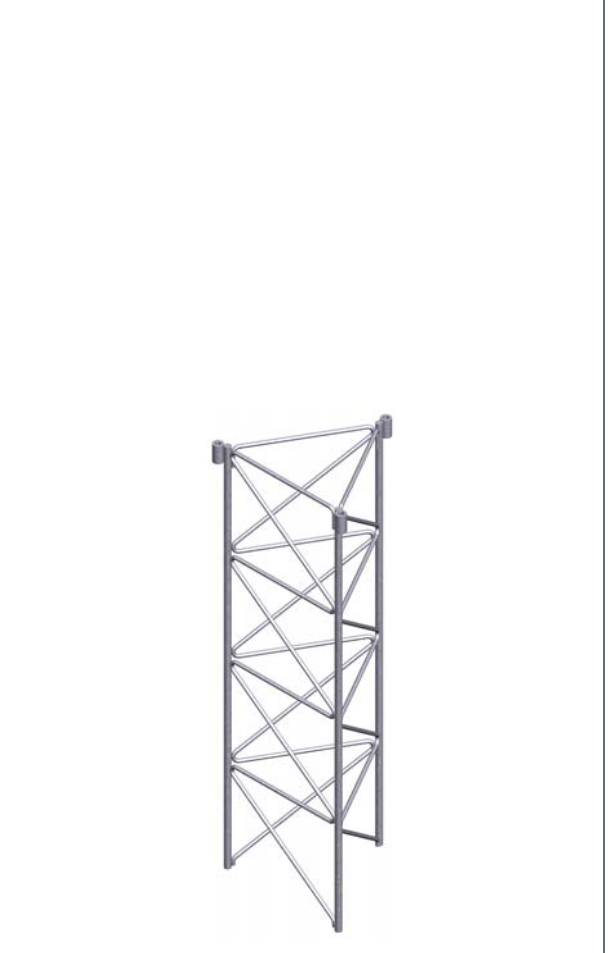
	<b>Standard Section–SuperTITAN Guyed</b> <i>(10' tall, 18" face width, c/w splice hardware)</i>	<b>5' Section–SuperTITAN Guyed</b> <i>(no hardware)</i>
Part Number	4.618.1504.010	4.618.8011.001
Weight	129 lbs [57.8 kg]	63 lbs [28.6 kg]
L"xW"xH"	120x18x18	60x18x18
		

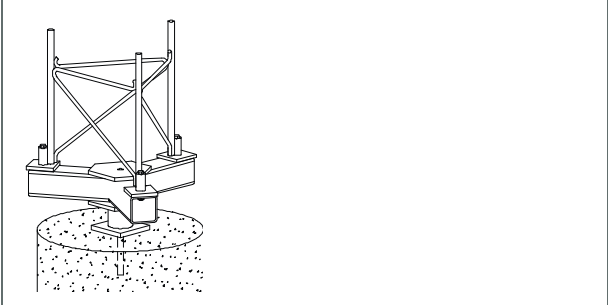
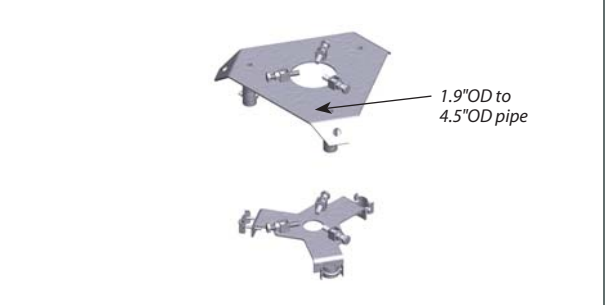
<b>Description:</b>	<b>Star Base Assembly</b> <i>(34.6 kips)</i>	<b>Top Section Adapter</b> <i>(pipe not included)</i>
Part Number	4.618.0602.021	4.618.2711.001
		

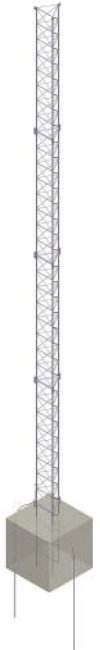

Part Number	Description	EIA 222-F Wind Load Area in ft <sup>2</sup> at 70/90/110mph*	Survival Wind Load Area in ft <sup>2</sup> at 70/90/110mph*	Ship Weight	L"xW"xH"	Image
4.618.SSTG.010	10' STG SS	54/30/20	90/50/36	311 lbs	120x18x18	
4.618.SSTG.020	20' STG SS	45/25/15	75/44/28	438 lbs	122x30x20	
4.618.SSTG.030	30' STG SS	25/12/7	45/24/14	564 lbs	122x40x20	
4.618.SSTG.040	40' STG SS	12/7/—*	27/13/7	691 lbs	122x48x20	
4.618.SSTG.050	50' STG SS	7/—/—*	17/8/2	818 lbs	122x56x20	
4.618.SSTG.060	60' STG SS	—/—/—*	10/3/—*	945 lbs	122x56x34	
4.618.SSTG.070	70' STG SS	—/—/—*	6/—/—*	1072 lbs	122x56x34	

All Self-Supporting Tower Kits come complete with an extra 5' Section so that the height in the description is the **actual** overall structure height.

\*For more information please contact Trylon directly.

4.618.SSTG.040  
Illustrated

\*Allowable antenna areas are based on one 1/2" and one 7/8" transmission line per 10 square feet; loads being centrally located and balanced over the tower top; all round members; and no ice.

## Foundation Details: Self-Support

Please email [info@trylon.com](mailto:info@trylon.com) for full installation manual.

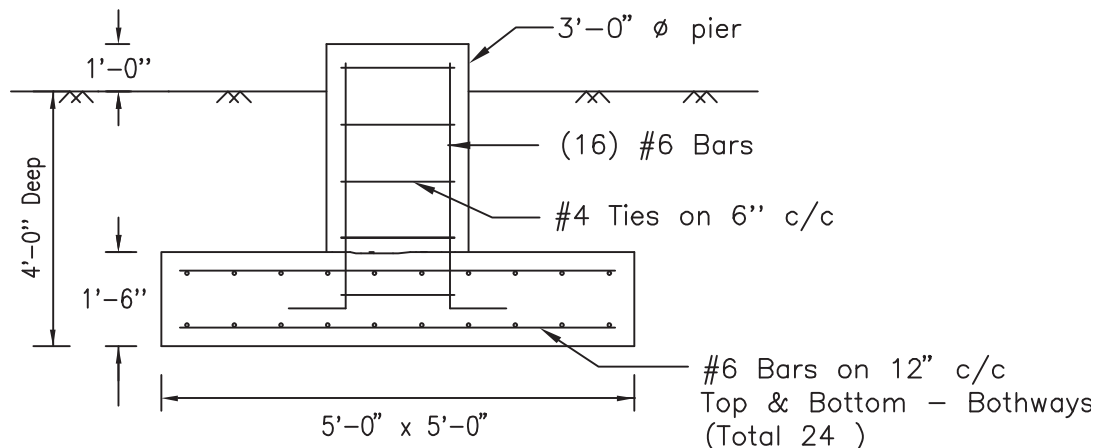

## Tower Selection Guide

Follow the steps below to determine if the bracketed STG can support your antenna load and wind pressure. The key to the strength of the tower is the number of unsupported sections above the building bracket, referred to as 'cantilever length' from here on.

**Step 1:** Select desired tower height (between 20' and 120') and write it in box (A). A

**Step 2:** Choose desired bracket attachment height (between 10' and 90' in increments of 10'). Write the bracket height in box (B). B

**Step 3:** Calculate your cantilever length (C) using the formula to the right. A - B = C

**Step 4:** Using the cantilever length calculated above, check the table below to determine if the tower height you need can support your antennas and wind pressure.

Cantilever Length "C" (above bracket)	Tower Height Range	EIA 222-F Allowable Antenna Area in ft <sup>2</sup> No ice at 70/80/90mph*	EIA 222-G Allowable Antenna Area in ft <sup>2</sup> No ice** at 85/100/110mph*
10'	20' to 60'	84/62/52	91/66/54
	70' to 90'	78/60/46	84/60/50
20'	30' to 100'	46/34/25	37/25/20
30'	40' to 110'	26/18/13	20/12/9
40'	50' to 120'	15/10/6	10/5/3

\* Allowable antenna areas are based on one 1/2" transmission line per 10 square feet; loads being centrally located and balanced over the tower top; all round members; and no ice.  
\*\* Reliability Class 1

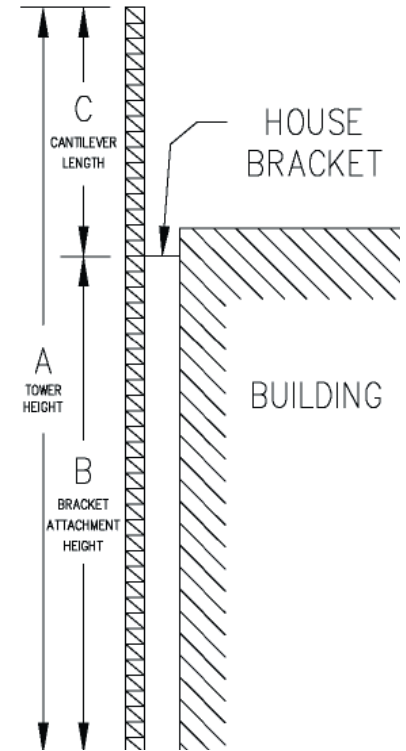

**Step 5:** Order your tower kit using part numbers from the Table below. Height shown is the overall tower height (A).

Part Number	Description	Ship Weight	L"xW"xH"
4.618.BSTG.020	20' STG Bracket	223 lbs	122x48x20
4.618.BSTG.030	30' STG Bracket	353 lbs	122x48x20
4.618.BSTG.040	40' STG Bracket	470 lbs	122x48x20
4.618.BSTG.050	50' STG Bracket	636 lbs	122x56x20
4.618.BSTG.060	60' STG Bracket	765 lbs	122x56x34
4.618.BSTG.070	70' STG Bracket	892 lbs	122x56x34
4.618.BSTG.080	80' STG Bracket	1221 lbs	122x56x34
4.618.BSTG.090	90' STG Bracket	1347 lbs	122x56x34
4.618.BSTG.100	100' STG Bracket	1274 lbs	122x56x49
4.618.BSTG.110	110' STG Bracket	1812 lbs	133x56x49
4.618.BSTG.120	120' STG Bracket	1939 lbs	133x56x49

## Foundation Details

Assumes maximum frost depth of 4'

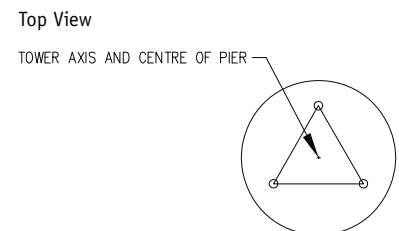
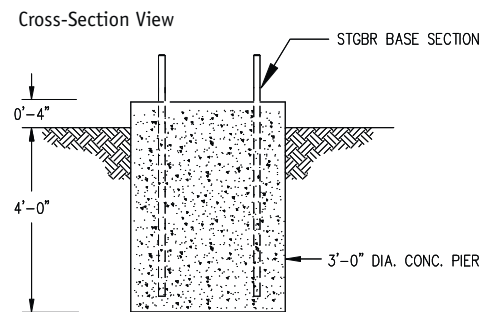

Please email [info@trylon.com](mailto:info@trylon.com) for full installation manual.

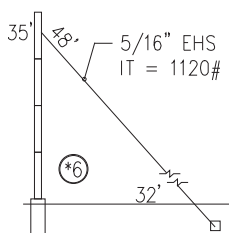
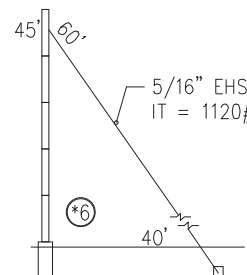
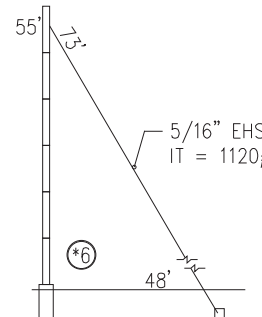
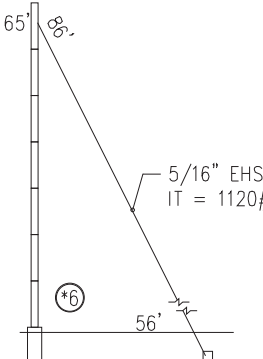
Tower Height:	40'	50'	60'	70'
Part Number	4.618.G000.040	4.618.G000.050	4.618.G000.060	4.618.G000.070
EIA 222-F* at 70/90/110mph-no ice	<b>Round: 100/54/38</b> <b>Flat: 60/32/22</b>	<b>Round: 95/53/37</b> <b>Flat: 57/31/22</b>	<b>Round: 90/52/36</b> <b>Flat: 54/31/21</b>	<b>Round: 87/51/34.5</b> <b>Flat: 52/30/20</b>
EIA 222-F* at 70/90/110mph-1/2" ice	<b>Round: 80/60/30</b> <b>Flat: 48/36/18</b>	<b>Round: 77/55/28</b> <b>Flat: 46/33/17</b>	<b>Round: 74/50/26</b> <b>Flat: 44/30/16</b>	<b>Round: 71/45/24</b> <b>Flat: 43/27/14</b>
Ship Weight	921 lbs [415 kg]	1054 lbs [474 kg]	1191 lbs [536 kg]	1324 lbs [596 kg]
Ship Dim. (L"xW"xH")	1@122x60x18 + 1@60x48x30	1@122x60x18 + 1@60x48x30	1@122x60x38 + 1@60x48x38	1@122x60x38 + 1@60x48x38
				

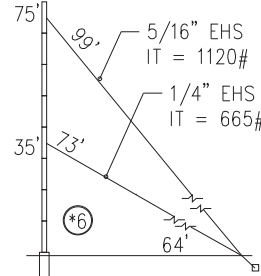
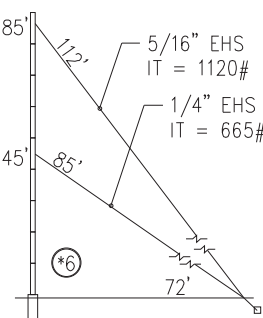
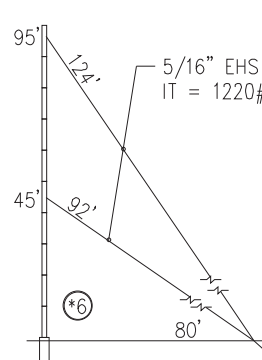
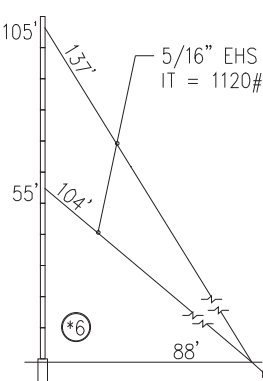
Tower Height:	80'	90'	100'	110'
Part Number	4.618.G000.080	4.618.G000.090	4.618.G000.100	4.618.G000.110
EIA 222-F* at 70/90/110mph-no ice	<b>Round: 85/50/33</b> <b>Flat: 51/30/20</b>	<b>Round: 80/49/32</b> <b>Flat: 48/29/19</b>	<b>Round: 75/48/31</b> <b>Flat: 45/28/18</b>	<b>Round: 70/47/30.5</b> <b>Flat: 42/28/18</b>
EIA 222-F* at 70/90/110mph-1/2" ice	<b>Round: 69/40/22</b> <b>Flat: 41/24/13</b>	<b>Round: 67/35/20</b> <b>Flat: 40/21/12</b>	<b>Round: 64/30/18</b> <b>Flat: 38/18/11</b>	<b>Round: 61/25/14</b> <b>Flat: 37/15/8</b>
Ship Weight	1534 lbs [690 kg]	1563 lbs [703 kg]	1860 lbs [837 kg]	2104 lbs [947 kg]
Ship Dim. (L"xW"xH")	1@122x60x38 + 1@60x48x38	1@122x60x38 + 1@60x48x38	1@122x60x38 + 1@60x48x38	1@122x60x60 + 1@60x48x40
				

\*Wind load area (ft<sup>2</sup>). See page 99 for Wind Load Data information.

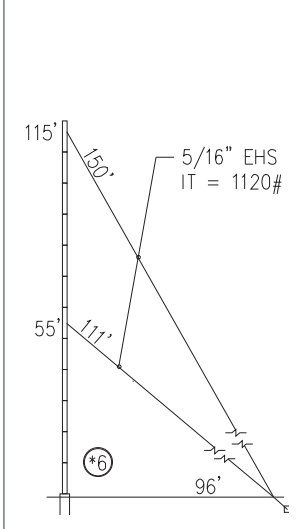
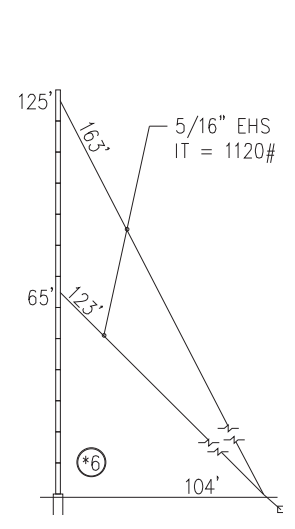
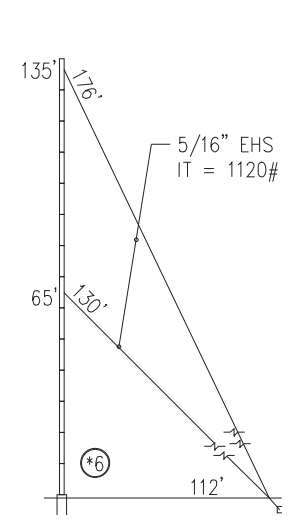
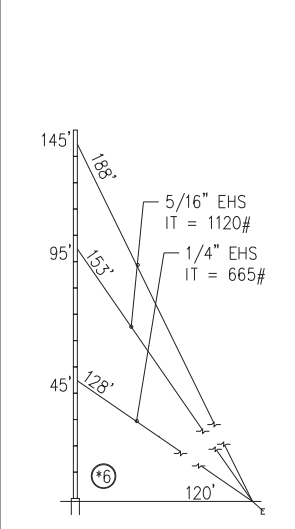
Tower Height:	120'	130'	140'	150'
Part Number	4.618.G000.120	4.618.G000.130	4.618.G000.140	4.618.G000.150
EIA 222-F* at 70/90/110mph-no ice	<b>Round: 65/46/30</b> <b>Flat: 39/27/18</b>	<b>Round: 62/45/29</b> <b>Flat: 37/27/17</b>	<b>Round: 60/44/28</b> <b>Flat: 36/26/16</b>	<b>Round: 58/43/26.5</b> <b>Flat: 34/25/15</b>
EIA 222-F* at 70/90/110mph-1/2" ice	<b>Round: 58/22/7</b> <b>Flat: 35/13/4</b>	<b>Round: 55/20/3</b> <b>Flat: 33/12/2</b>	<b>Round: 52/17/—</b> <b>Flat: 31/10/—</b>	<b>Round: 49/15/—</b> <b>Flat: 29/9/—</b>
Ship Weight	2248 lbs [1012 kg]	2391 lbs [1076 kg]	2529 lbs [1138 kg]	2777 lbs [1250 kg]
Ship Dim. (L"xW"xH")	1@122x60x60 + 1@60x48x40	1@122x60x60 + 1@60x48x42	1@122x60x60 + 1@60x48x44	1@122x60x60 + 1@60x48x46
				

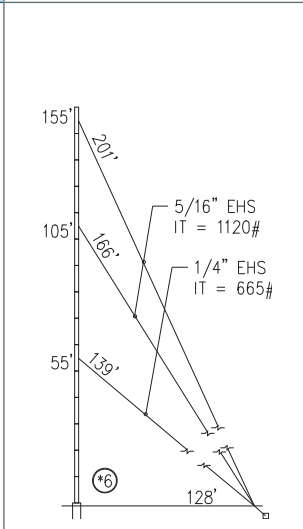
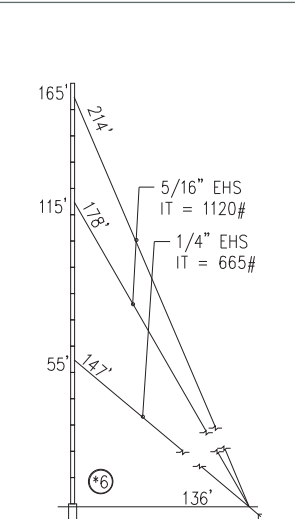
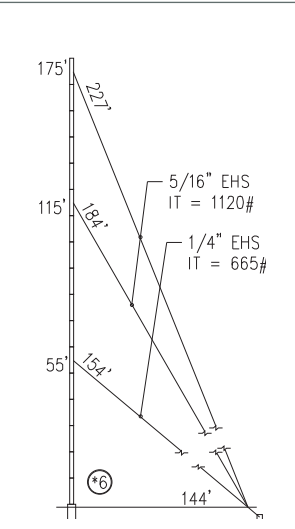
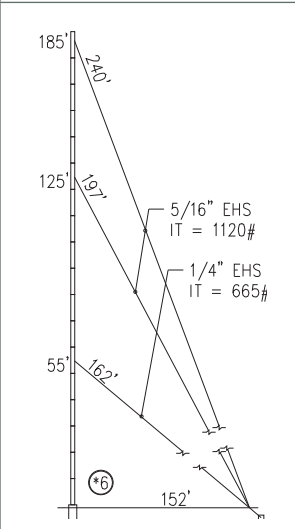
Tower Height:	160'	170'	180'	190'
Part Number	4.618.G000.160	4.618.G000.170	4.618.G000.180	4.618.G000.190
EIA 222-F* at 70/90/110mph-no ice	<b>Round: 56/42/25</b> <b>Flat: 33/25/15</b>	<b>Round: 54/41/24</b> <b>Flat: 32/24/14</b>	<b>Round: 52/40/23</b> <b>Flat: 31/24/13</b>	<b>Round: 50/39/22</b> <b>Flat: 30/23/13</b>
EIA 222-F* at 70/90/110mph-1/2" ice	<b>Round: 47/13/—</b> <b>Flat: 28/8/—</b>	<b>Round: 44/11/—</b> <b>Flat: 26/7/—</b>	<b>Round: 41/9/—</b> <b>Flat: 25/5/—</b>	<b>Round: 38/7/—</b> <b>Flat: 23/4/—</b>
Ship Weight	2924 lbs [1316 kg]	3070 lbs [1382 kg]	3217 lbs [1448 kg]	3363 lbs [1514 kg]
Ship Dim. (L"xW"xH")	1@122x60x60 + 1@60x48x48	2@122x60x60	2@122x60x60	2@122x60x60
				

\*Wind load area (ft²). See page 99 for Wind Load Data information.

Tower Height:	200'	210'	220'	230'
Part Number	4.618.G000.200	4.618.G000.210	4.618.G000.220	4.618.G000.230
EIA 222-F* at 70/90/110mph-no ice	<b>Round: 49/38/21</b> <b>Flat: 29/22/12</b>	<b>Round: 48/37.5/20</b> <b>Flat: 28/22/12</b>	<b>Round: 47/37/19</b> <b>Flat: 28/22/11</b>	<b>Round: 46/36/18</b> <b>Flat: 27/21/10</b>
EIA 222-F* at 70/90/110mph-1/2" ice	<b>Round: 36/5/—</b> <b>Flat: 22/3/—</b>	<b>Round: 34/—/—</b> <b>Flat: 20/—/—</b>	<b>Round: 31/—/—</b> <b>Flat: 19/—/—</b>	<b>Round: 28/—/—</b> <b>Flat: 17/—/—</b>
Ship Weight	3658 lbs [1646 kg]	3912 lbs [1761 kg]	4070 lbs [1832 kg]	4219 lbs [1899 kg]
Ship Dim. (L"xW"xH")	2@122x60x60	2@122x60x60	2@122x60x60	2@122x60x60

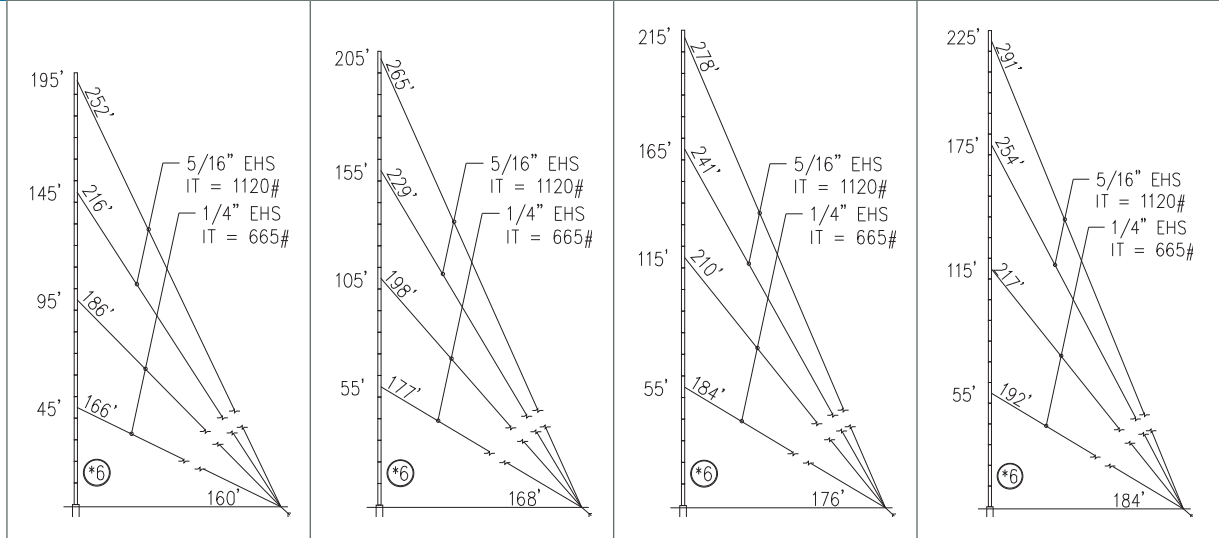

Tower Height:	240'	250'	260'	270'
Part Number	4.618.G000.240	4.618.G000.250	4.618.G000.260	4.618.G000.270
EIA 222-F* at 70/90/110mph-no ice	<b>Round: 45/35/16</b> <b>Flat: 27/21/9</b>	<b>Round: 44/34.5/15</b> <b>Flat: 26/20/9</b>	<b>Round: 43/34/13</b> <b>Flat: 25/20/7</b>	<b>Round: 42/33/12</b> <b>Flat: 25/19/7</b>
EIA 222-F* at 70/90/110mph-1/2" ice	<b>Round: 25/—/—</b> <b>Flat: 15/—/—</b>	<b>Round: 22/—/—</b> <b>Flat: 13/—/—</b>	<b>Round: 20/—/—</b> <b>Flat: 12/—/—</b>	<b>Round: 17/—/—</b> <b>Flat: 10/—/—</b>
Ship Weight	4360 lbs [1962 kg]	4513 lbs [2058 kg]	4671 lbs [2102 kg]	5052 lbs [2274 kg]
Ship Dim. (L"xW"xH")	2@122x60x60	2@122x60x60	2@122x60x60	2@122x60x60

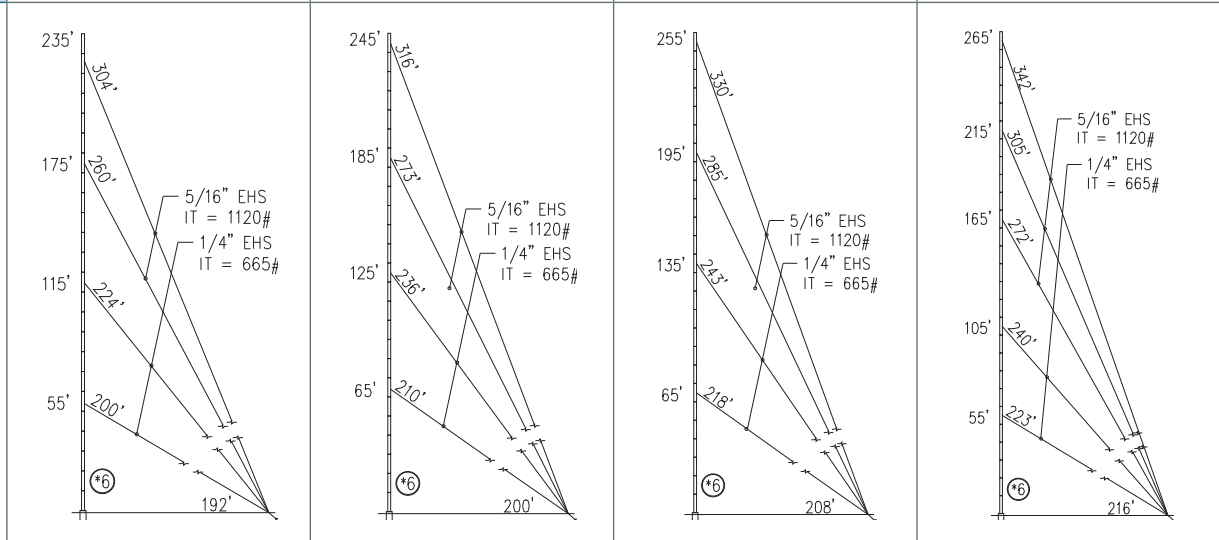

\*Wind load area (ft<sup>2</sup>). See page 99 for Wind Load Data information.

Tower Height:	280'	290'	300'	310'
Part Number	4.618.G000.280	4.618.G000.290	4.618.G000.300	4.618.G000.310
EIA 222-F* at 70/90/110mph-no ice	<b>Round: 41/32/15</b> <b>Flat: 24/18/6</b>	<b>Round: 40/31/14.5</b> <b>Flat: 24/18/3</b>	<b>Round: 39/30/14</b> <b>Flat: 23/16/3</b>	<b>Round: 38/26/—</b> <b>Flat: 22/15/—</b>
EIA 222-F* at 70/90/110mph-1/2" ice	<b>Round: 14/—/—</b> <b>Flat: 8/—/—</b>	<b>Round: 12/—/—</b> <b>Flat: 7/—/—</b>	<b>Round: 8/—/—</b> <b>Flat: 5/—/—</b>	<b>Round: 6/—/—</b> <b>Flat: 4/—/—</b>
Ship Weight	5207 lbs [2343 kg]	5363 lbs [2414 kg]	5521 lbs [2485 kg]	5782 lbs [2602 kg]
Ship Dim. (L"xW"xH")	2@122x60x60	2@122x60x60	2@122x60x60	2@122x60x60

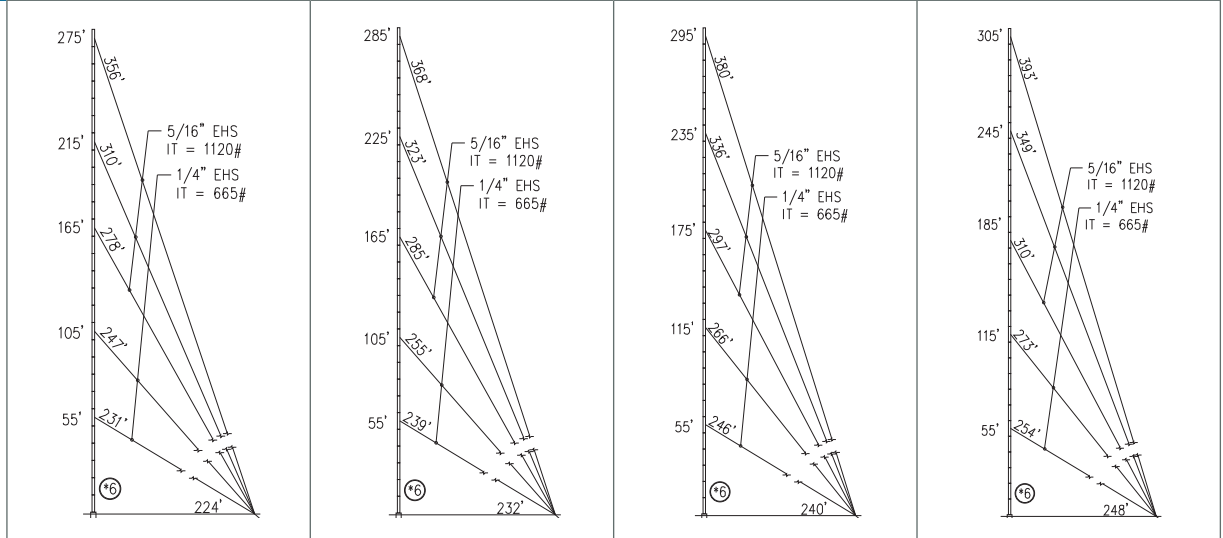

Tower Height:	320'	330'
Part Number	4.618.G000.320	4.618.G000.330
EIA 222-F* at 70/90/110mph-no ice	<b>Round: 37/2/—</b> <b>Flat: 22/15/—</b>	<b>Round: 36/24/—</b> <b>Flat: 21/14/—</b>
EIA 222-F* at 70/90/110mph-1/2" ice	<b>Round: 4/—/—</b> <b>Flat: 2/—/—</b>	<b>Round: —/—/—</b> <b>Flat: —/—/—</b>
Ship Weight	5938 lbs [2672 kg]	6292 lbs [2832 kg]
Ship Dim. (L"xW"xH")	2@122x60x60 + 1@60x48x48	2@122x60x60 + 1@122x60x24

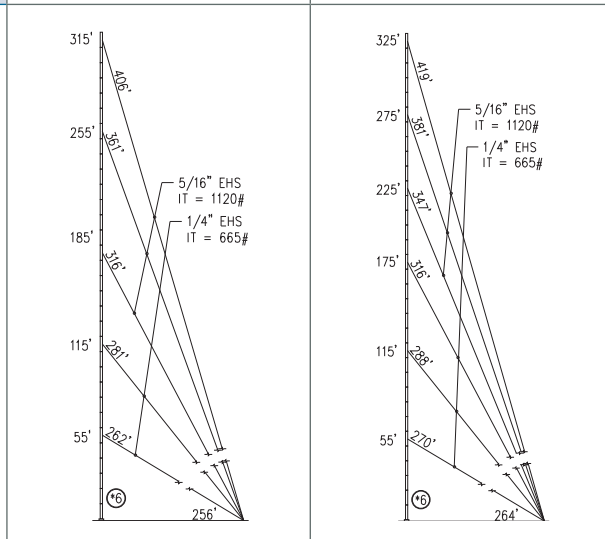

\*Wind load area (ft²). See page 99 for Wind Load Data information.



Tower Height:	340'	350'	360'	370'
Part Number	4.618.G000.340	4.618.G000.350	4.618.G000.360	4.618.G000.370
EIA 222-F* at 70/90/110mph-no ice	<b>Round: 35/23/—</b> <b>Flat: 21/13/—</b>	<b>Round: 34/22/—</b> <b>Flat: 20/13/—</b>	<b>Round: 33/21/—</b> <b>Flat: 19/12/—</b>	<b>Round: 32/20/—</b> <b>Flat: 19/12/—</b>
EIA 222-F* at 70/90/110mph-1/2" ice	<b>Round: —/—/—</b> <b>Flat: —/—/—</b>	<b>Round: —/—/—</b> <b>Flat: —/—/—</b>	<b>Round: —/—/—</b> <b>Flat: —/—/—</b>	<b>Round: —/—/—</b> <b>Flat: —/—/—</b>
Ship Weight	6456 lbs [2905 kg]	6892 lbs [3102 kg]	7067 lbs [3180 kg]	7225 lbs [3252 kg]
Ship Dim. (L"xW"xH")	2@122x60x60 + 1@122x60x24	2@122x60x60 + 1@122x60x24	2@122x60x60 + 1@122x60x24	2@122x60x60 + 1@122x60x24

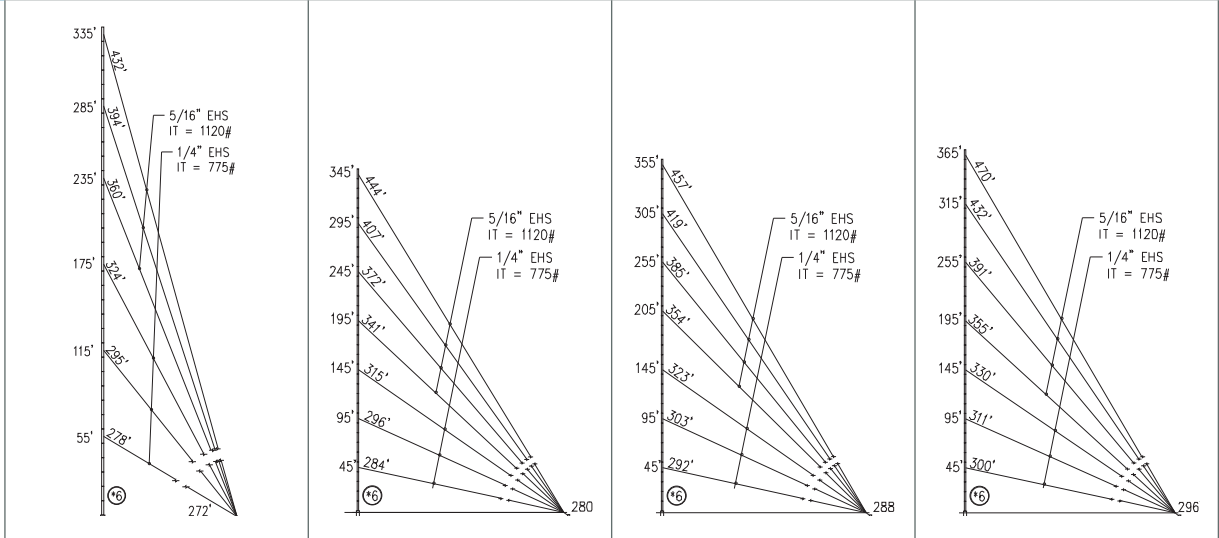

Tower Height:	380'	390'	400'	410'
Part Number	4.618.G000.380	4.618.G000.390	4.618.G000.400	4.618.G000.410
EIA 222-F* at 70/90/110mph-no ice	<b>Round: 31/19/—</b> <b>Flat: 18/11/—</b>	<b>Round: 30/18/—</b> <b>Flat: 18/10/—</b>	<b>Round: 29/17/—</b> <b>Flat: 17/10/—</b>	<b>Round: 28/—/—</b> <b>Flat: 16/—/—</b>
EIA 222-F* at 70/90/110mph-1/2" ice	<b>Round: —/—/—</b> <b>Flat: —/—/—</b>	<b>Round: —/—/—</b> <b>Flat: —/—/—</b>	<b>Round: —/—/—</b> <b>Flat: —/—/—</b>	<b>Round: —/—/—</b> <b>Flat: —/—/—</b>
Ship Weight	7389 lbs [3325 kg]	7569 lbs [3406 kg]	7728 lbs [3478 kg]	7920 lbs [3564 kg]
Ship Dim. (L"xW"xH")	2@122x60x60 + 1@122x60x38	2@122x60x60 + 1@122x60x38	2@122x60x60 + 1@122x60x38	2@122x60x60 + 1@122x60x38

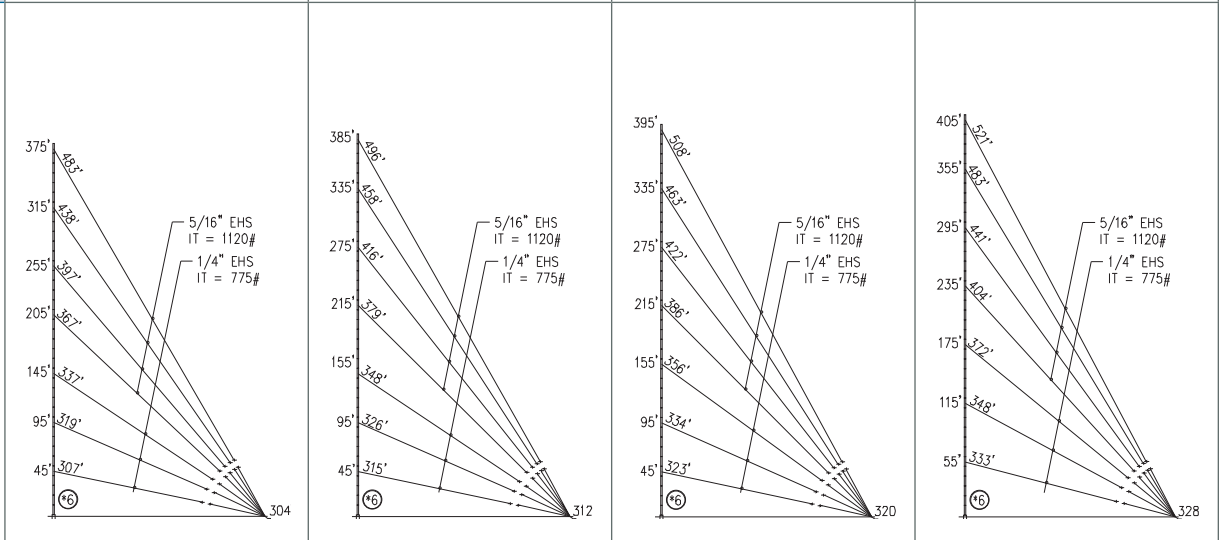

\*Wind load area (ft<sup>2</sup>). See page 99 for Wind Load Data information.

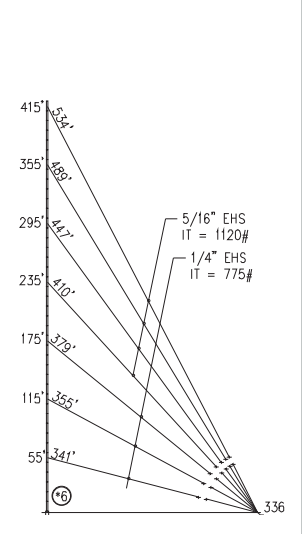
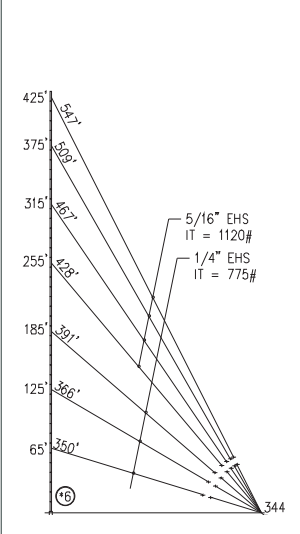
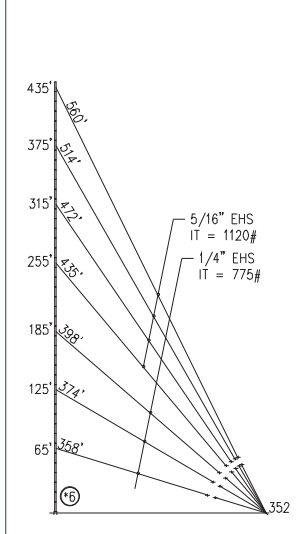
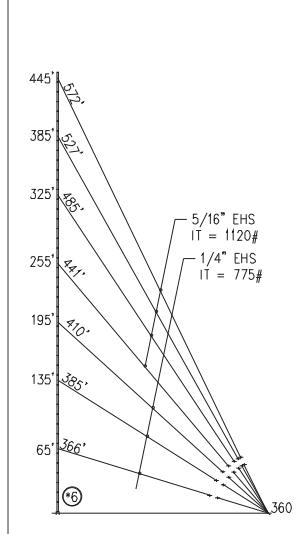
Tower Height:	420'	430'	440'	450'
Part Number	4.618.G000.420	4.618.G000.430	4.618.G000.440	4.618.G000.450
EIA 222-F* at 70/90/110mph-no ice	<b>Round: 27/—/—</b> <b>Flat: 16/—/—</b>	<b>Round: 26/—/—</b> <b>Flat: 15/—/—</b>	<b>Round: 25/—/—</b> <b>Flat: 15/—/—</b>	<b>Round: 24/—/—</b> <b>Flat: 14/—/—</b>
EIA 222-F* at 70/90/110mph-1/2" ice	<b>Round: —/—/—</b> <b>Flat: —/—/—</b>	<b>Round: —/—/—</b> <b>Flat: —/—/—</b>	<b>Round: —/—/—</b> <b>Flat: —/—/—</b>	<b>Round: —/—/—</b> <b>Flat: —/—/—</b>
Ship Weight	8078 lbs [3635 kg]	8267 lbs [3721 kg]	8420 lbs [3789 kg]	8592 lbs [3867 kg]
Ship Dim. (L"xW"xH")	2@122x60x60 + 1@122x60x38	2@122x60x60 + 1@122x60x54	2@122x60x60 + 1@122x60x54	2@122x60x60 + 1@122x60x54
				

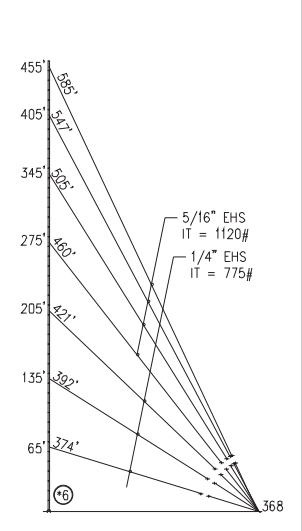
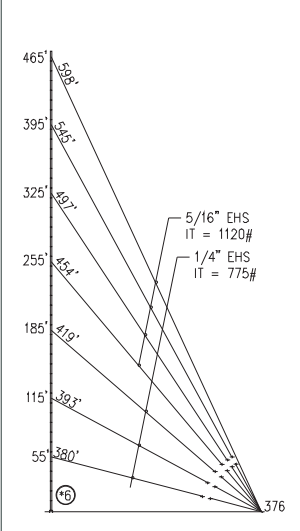
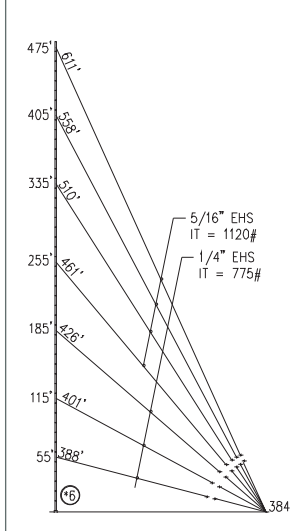
Tower Height:	460'	470'	480'
Part Number	4.618.G000.460	4.618.G000.470	4.618.G000.480
EIA 222-F* at 70/90/110mph-no ice	<b>Round: 23/—/—</b> <b>Flat: 13/—/—</b>	<b>Round: 22/—/—</b> <b>Flat: 13/—/—</b>	<b>Round: 21/—/—</b> <b>Flat: 12/—/—</b>
EIA 222-F* at 70/90/110mph-1/2" ice	<b>Round: —/—/—</b> <b>Flat: —/—/—</b>	<b>Round: —/—/—</b> <b>Flat: —/—/—</b>	<b>Round: —/—/—</b> <b>Flat: —/—/—</b>
Ship Weight	8778 lbs [3950 kg]	8908 lbs [4009 kg]	9077 lbs [4085 kg]
Ship Dim. (L"xW"xH")	2@122x60x60 + 1@122x60x54	2@122x60x60 + 1@122x60x54	3@122x60x60 + 1@60x48x60
			

\*Wind load area (ft<sup>2</sup>). Allowable antenna area for round member antennas at 70/90/110mph wind speeds with no ice; designed in accordance with national standard ANSI/EIA 222; and based on loads being centrally located and balanced over the tower top. For flat plate equivalent (FPE) areas, divide by a factor of 1.5.

 **STG SERIES** SuperTITAN Guyed™ Kits

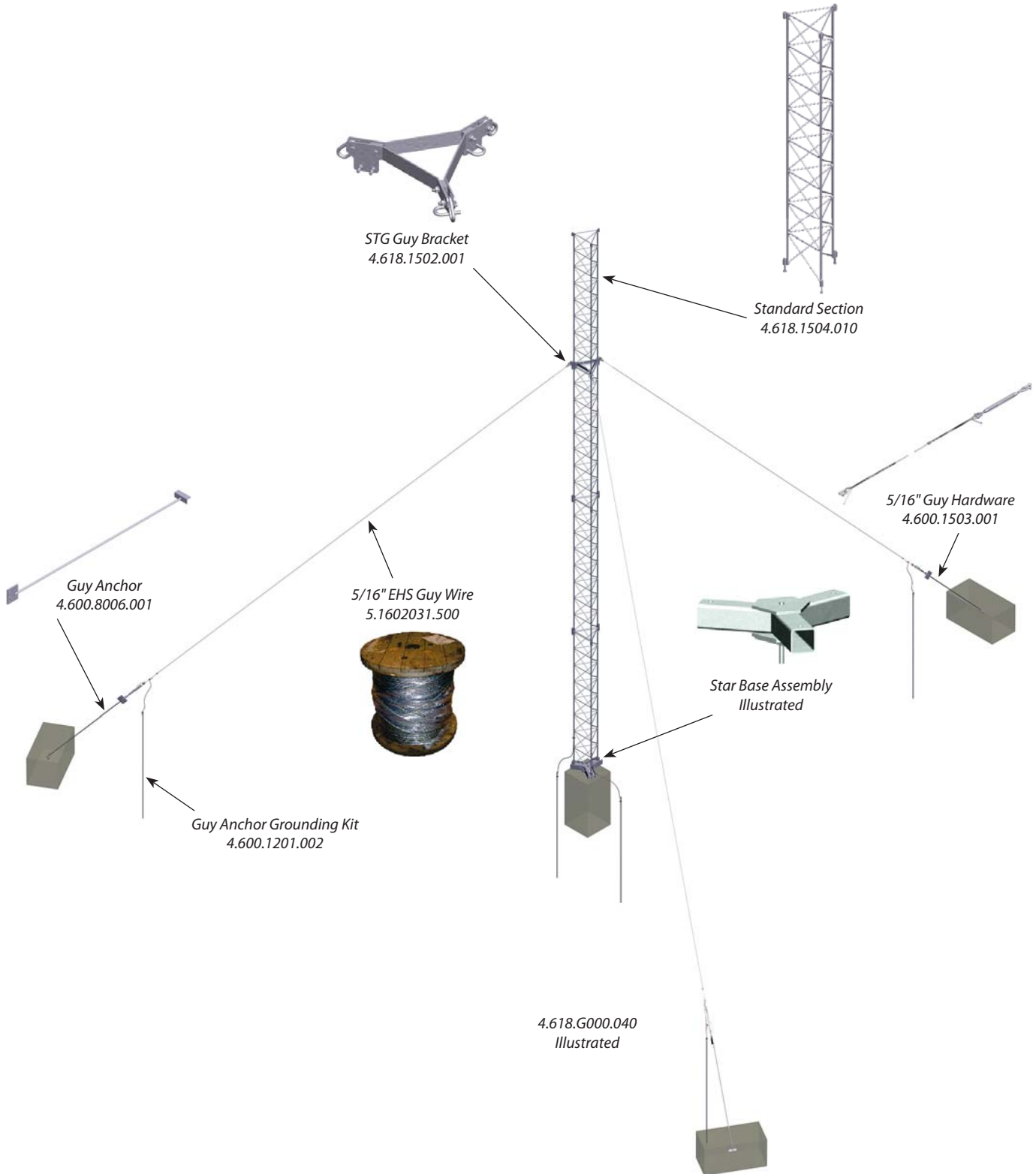

# Concrete Foundation Details STG SERIES

(Normal dry soil)



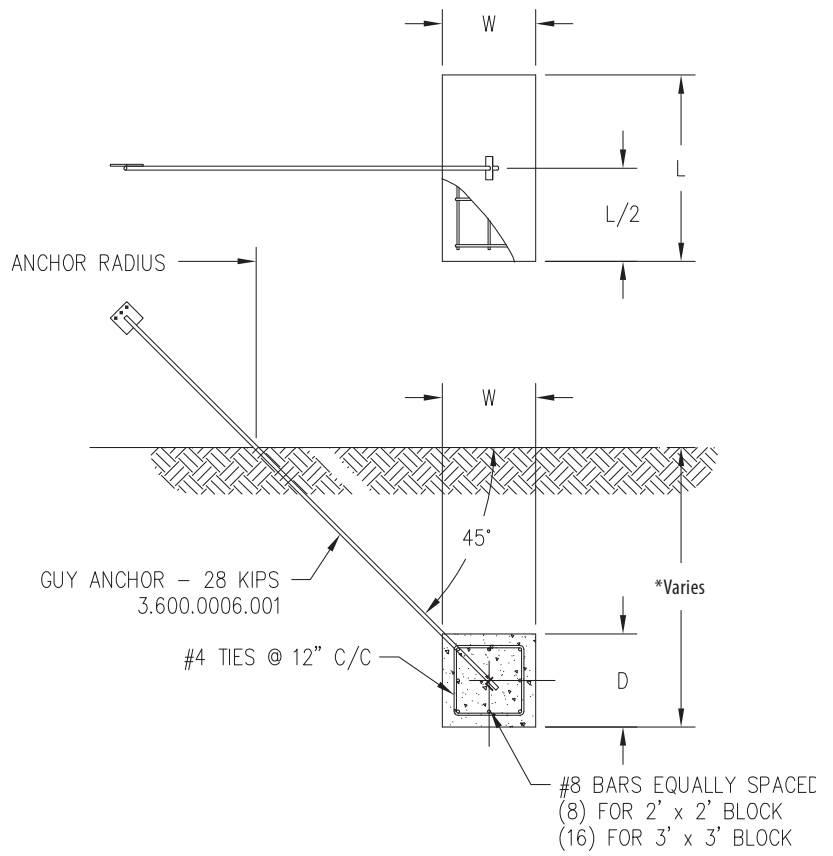
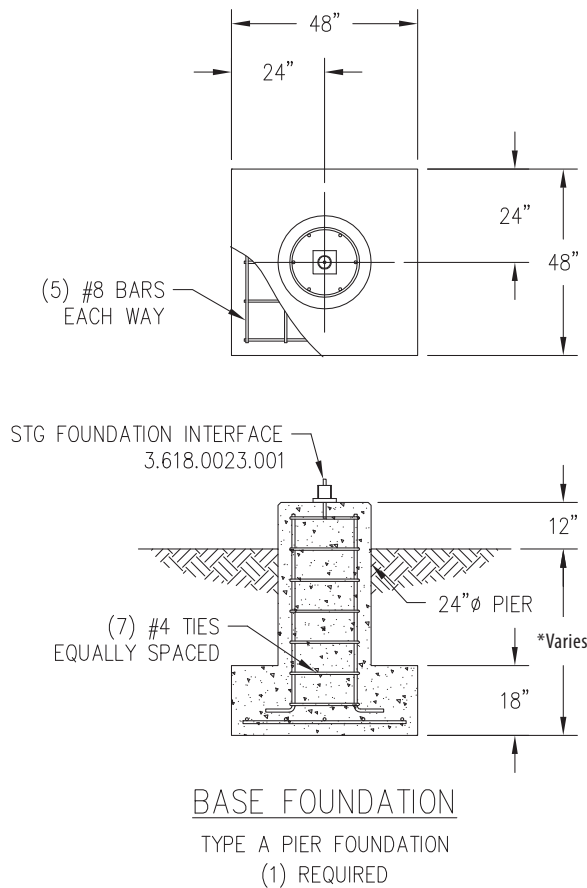

Please email [info@trylon.com](mailto:info@trylon.com) for full installation manual.







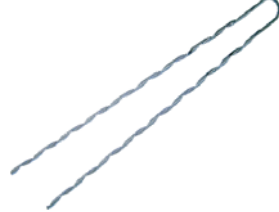
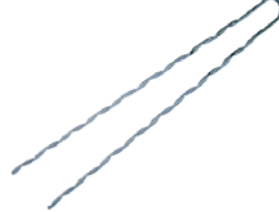

FOUNDATION TYPE	DIMENSIONS				MAX LOAD (LBS)		
	W	D	L	L/2	AXIAL	HORIZ	VERT
B	3'	3'	11'	5.5'	28,000	20,000	20,000
C	3'	3'	8'	4'	21,000	15,000	15,000
D	2'	2'	6'	3'	14,000	10,000	10,000
E	2'	2'	4'	2'	7,000	5,000	5,000

\* Note: Please contact Trylon for frost depth information.

Description:	5/16" x 500' EHS Guy Wire	5/16" x 1000' EHS Guy Wire	1/4" x 500' EHS Guy Wire	1/4" x 1000' EHS Guy Wire
Part Number	5.1602031.500	5.1602031.1000	5.1602030.500	5.1602030.1000
				

Description:	1/4" Guy Hardware	5/16" Guy Hardware	3/8" Thimble <i>(for use with 1/4" and 5/16" EHS)</i>	7/16" Shackle <i>(for use with 1/4" and 5/16" EHS)</i>
Part Number	4.600.1502.001	4.600.1503.001	5.1601650	5.1601600
				

Description:	1/4" Big Grip <i>(for use with 1/4" EHS)</i>	5/16" Big Grip <i>(for use with 5/16" EHS)</i>	Hose Clamp <i>(for 3/16", 1/4", and 5/16" EHS)</i>	1/4" End Sleeve <i>(for use with 1/4" EHS)</i>
Part Number	5.1607047	5.1607048	5.2204020	5.1607077
				

Description:	5/16" End Sleeve <i>(for use with 5/16" EHS)</i>	1/2" x 12" Turnbuckle <i>(for use with 3/16" and 1/4" EHS)</i>	5/8" x 12" Turnbuckle <i>(for use with 5/16" EHS)</i>	1/4" U-Bolt Clip
Part Number	5.1607078	5.1601700	5.1601705	5.1601302
				

**Basic Light Kit** (dual obstruction red lights, non-alarmed, steady burning, no photocell, c/w lights, cable, connectors, ty wraps, etc.)

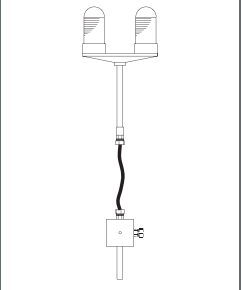
Part Number	Description	Ship Wt. (lbs)*	Image
4.93.0200.150	Basic DOL Light Kit, 0 to 150' towers	60	

\* Packaging includes three pieces: one box with lights only (20"L x 8"W x 10"H), one reel of tech cable (24"OD x 12"H), and one box of all other components (8"L x 8"W x 16"H).

**Light Kit with Photocell** (non-alarmed, c/w red lights, cable, connectors, ty wraps, etc.)

Part Number	Description	Ship Wt. (lbs)	Image
4.93.STGP.150	0-150' DOL Light Kit	90	
4.93.STGP.350	151-350' Beacon Light Kit	200	
4.93.STGP.480	351-480' Beacon Light Kit	300	

**Light Kit with Alarmed Controller and Photocell** (c/w red lights, cable, connectors, ty wraps, etc.)

Part Number	Description	Ship Wt. (lbs)	Image
4.93.STGA.150	0-150' DOL Light Kit	90	
4.93.STGA.350	151-350' Beacon Light Kit	200	
4.93.STGA.480	351-480' Beacon Light Kit	300	

**White Strobe Light Kit** (medium intensity, c/w cable, connectors, etc., no mid DOL)



Part Number	Description	Ship Wt. (lbs)	Image
4.93.STGW.150	STG White Strobe Kit, 0 to 150' towers	157	
4.93.STGW.250	STG White Strobe Kit, 151' to 250' towers	203	



**48VDC LED Light Kit with Photocell** (ideal for sites powered by solar energy)



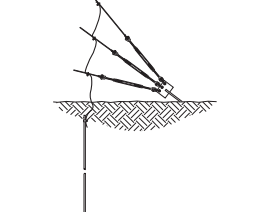

Part Number	Description	Ship Wt. (lbs)	Image
4.93.LED1.150	0'-150' LED dual obstruction light kit, photocell, no SOL	150	
4.93.LED3.200	160'-190' LED beacon light kit, photocell, two LED SOL	180	

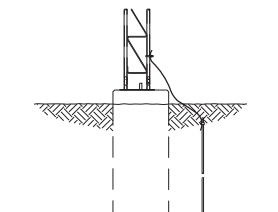
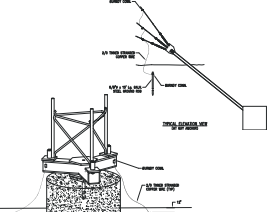

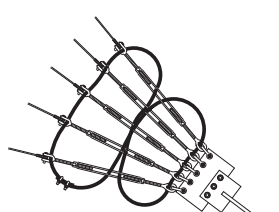
Description:	STG Splice Kit	STG Guy Bracket Assembly	STG Torsion Resistor	Guy Anchor (28 kips)
Part Number	4.618.1501.001	4.618.1502.001	4.618.2101.001	4.600.8006.001
				

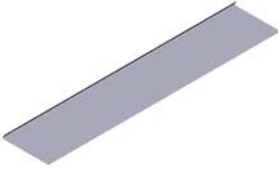
Description:	5 Guy Elevation Expansion Kit	7 Guy Elevation Expansion Kit	Guy Rock Anchor (4' shaft)	Guy Anchor Grounding Kit
Part Number	4.600.0602.001	4.600.0602.002	4.600.0603.004	4.600.1201.002
				

Description:	Tower Base Grounding Kit	2-Leg Grounding EIA Compliant	Ground Connector	Turnbuckle Anti-Rotation
Part Number	4.600.1201.001	4.91.0103.004	5.1303086	4.600.1506.001
				







Description:	STG Anti-Climb Kit (3-pak)	HD Universal House Bracket (6"-36")	GAC303 Guy Anchor (7.5 kips)	GAW25 Wall and Roof Mount
Part Number	4.618.3601.001	4.600.5401.001	4.600.8001.001	4.600.5403.001
				

Description:	STG Work Platform	25T/STG–Site Warning Package	Side Arm Bracket–1 Level	Side Arm Bracket–2 Level
Part Number	4.618.1801.001	4.600.7201.001	4.600.2701.001	4.600.2702.001

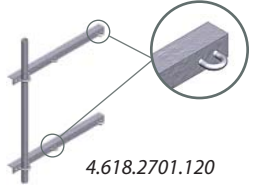
Description:	Beacon Plate Assembly	25T/STG Lightning Rod (5' long)	25T/STG Lightning Rod (8' long)	Ballast Roof Mount
Part Number	4.618.4201.001	4.90.0618.C05	4.600.1202.008	4.618.5102.001

Description:	TB3 Thrust Bearing (supports up to 2"OD Mast)	TB4 Thrust Bearing (supports up to 3"OD Mast)	Bolted Foundation Kit	Bearing Plate
Part Number	4.600.2703.001	4.600.2704.001	4.618.0605.001	4.618.2715.001

Description:	EB2525T Universal Eave Bracket
Part Number	4.600.5101.001

Part Number	Description	Ship Weight (lbs)	Ship L'xW"xH"	Image
4.618.2701.115	STG-1' Side Arm Kit c/w 1.900"OD Pipe	32	36x6x6	 <p>4.618.2701.120</p>
4.618.2701.120	STG-1' Side Arm Kit c/w 2.375"OD Pipe	41	36x6x6	
4.618.2701.125	STG-1' Side Arm Kit c/w 2.875"OD Pipe	45	36x6x6	
4.618.2701.130	STG-1' Side Arm Kit c/w 3.500"OD Pipe	50	36x6x6	
4.618.2701.135	STG-1' Side Arm Kit c/w 4.000"OD Pipe	65	36x6x6	
4.618.2701.140	STG-1' Side Arm Kit c/w 4.500"OD Pipe	71	36x6x6	
4.618.2701.215	STG-2' Side Arm Kit c/w 1.900"OD Pipe	37	48x6x6	 <p>4.618.2701.220</p>
4.618.2701.220	STG-2' Side Arm Kit c/w 2.375"OD Pipe	46	48x6x6	
4.618.2701.225	STG-2' Side Arm Kit c/w 2.875"OD Pipe	50	48x6x6	
4.618.2701.230	STG-2' Side Arm Kit c/w 3.500"OD Pipe	55	48x6x6	
4.618.2701.235	STG-2' Side Arm Kit c/w 4.000"OD Pipe	70	48x6x6	
4.618.2701.240	STG-2' Side Arm Kit c/w 4.500"OD Pipe	76	48x6x6	
4.618.2701.315	STG-3' Side Arm Kit c/w 1.900"OD Pipe	42	60x6x6	 <p>4.618.2701.320</p>
4.618.2701.320	STG-3' Side Arm Kit c/w 2.375"OD Pipe	51	60x6x6	
4.618.2701.325	STG-3' Side Arm Kit c/w 2.875"OD Pipe	55	60x6x6	
4.618.2701.330	STG-3' Side Arm Kit c/w 3.500"OD Pipe	61	60x6x6	
4.618.2701.335	STG-3' Side Arm Kit c/w 4.000"OD Pipe	75	60x6x6	
4.618.2701.340	STG-3' Side Arm Kit c/w 4.500"OD Pipe	81	60x6x6	
4.618.2701.415	STG-4' Side Arm Kit c/w 1.900"OD Pipe	55	72x6x6	 <p>4.618.2701.420</p>
4.618.2701.420	STG-4' Side Arm Kit c/w 2.375"OD Pipe	64	72x6x6	
4.618.2701.425	STG-4' Side Arm Kit c/w 2.875"OD Pipe	68	72x6x6	
4.618.2701.430	STG-4' Side Arm Kit c/w 3.500"OD Pipe	74	72x6x6	
4.618.2701.435	STG-4' Side Arm Kit c/w 4.000"OD Pipe	88	72x6x6	
4.618.2701.440	STG-4' Side Arm Kit c/w 4.500"OD Pipe	94	72x6x6	
4.618.2701.515	STG-5' Side Arm Kit c/w 1.900"OD Pipe	62	84x6x6x	 <p>4.618.2701.520</p>
4.618.2701.520	STG-5' Side Arm Kit c/w 2.375"OD Pipe	71	84x6x6x	
4.618.2701.525	STG-5' Side Arm Kit c/w 2.875"OD Pipe	75	84x6x6x	
4.618.2701.530	STG-5' Side Arm Kit c/w 3.500"OD Pipe	80	84x6x6x	
4.618.2701.535	STG-5' Side Arm Kit c/w 4.000"OD Pipe	95	84x6x6x	
4.618.2701.540	STG-5' Side Arm Kit c/w 4.500"OD Pipe	100	84x6x6x	
4.618.2701.615	STG-6' Side Arm Kit c/w 1.900"OD Pipe	68	96x6x6	 <p>4.618.2701.620</p>
4.618.2701.620	STG-6' Side Arm Kit c/w 2.375"OD Pipe	77	96x6x6	
4.618.2701.625	STG-6' Side Arm Kit c/w 2.875"OD Pipe	81	96x6x6	
4.618.2701.630	STG-6' Side Arm Kit c/w 3.500"OD Pipe	86	96x6x6	
4.618.2701.635	STG-6' Side Arm Kit c/w 4.000"OD Pipe	101	96x6x6	
4.618.2701.640	STG-6' Side Arm Kit c/w 4.500"OD Pipe	107	96x6x6	

Part Number	Description	Ship Weight (lbs)	Ship L"xW"xH"	Image
4.618.2702.115	STG-Face Mount c/w 1.900"OD Pipe	38	60x6x6	 <p>4.618.2702.120 Face Mount</p> <p>4.618.2702.220 Leg Mount</p>
4.618.2702.120	STG-Face Mount c/w 2.375"OD Pipe	53	60x6x6	
4.618.2702.125	STG-Face Mount c/w 2.875"OD Pipe	60	60x6x6	
4.618.2702.130	STG-Face Mount c/w 3.500"OD Pipe	69	60x6x6	
4.618.2702.135	STG-Face Mount c/w 4.000"OD Pipe	95	60x6x6	
4.618.2702.140	STG-Face Mount c/w 4.500"OD Pipe	104	60x6x6	
4.618.2702.215	STG-Leg Mount c/w 1.900"OD Pipe	37	60x6x6	
4.618.2702.220	STG-Leg Mount c/w 2.375"OD Pipe	52	60x6x6	
4.618.2702.225	STG-Leg Mount c/w 2.875"OD Pipe	59	60x6x6	
4.618.2702.230	STG-Leg Mount c/w 3.500"OD Pipe	69	60x6x6	
4.618.2702.235	STG-Leg Mount c/w 4.000"OD Pipe	94	60x6x6	
4.618.2702.240	STG-Leg Mount c/w 4.500"OD Pipe	104	60x6x6	

Cable Safety Climb Kits (OSHA approved; ANSI compliant; 3/8" aircraft)				
Part Number	Description	Ship Weight (lbs)	Ship L"xW"xH"	Image
4.99.0250.000	Cable Safety Climb Kit up to 50' STG, no slider	47	32x10x6	
4.99.0300.000	Cable Safety Climb Kit up to 100' STG, no slider	60	32x12x12	
4.99.0305.000	Cable Safety Climb Kit up to 150' STG, no slider	75	32x14x14	
4.99.0310.000	Cable Safety Climb Kit up to 200' STG, no slider	87	32x14x14	
4.99.0315.000	Cable Safety Climb Kit up to 250' STG, no slider	102	32x14x16	
4.99.0320.000	Cable Safety Climb Kit up to 300' STG, no slider	117	32x14x18	
4.99.0325.000	Cable Safety Climb Kit up to 350' STG, no slider	129	40x40x18	
4.99.0330.000	Cable Safety Climb Kit up to 400' STG, no slider	144	40x40x20	
4.99.0335.000	Cable Safety Climb Kit up to 450' STG, no slider	158	40x40x20	
4.99.0340.000	Cable Safety Climb Kit up to 500' STG, no slider	173	40x40x20	

Safety Climb Slider				
Part Number	Description	Ship Weight (lbs)	Ship L"xW"xH"	Image
4.99.0101.001	Cougar Stainless Steel Cable Slider w/Karabiner	4	6x4x3	

Antenna Cluster Mounts				
Part Number	Description	Ship Weight (lbs)	Ship L"xW"xH"	Image
4.84.3CLS.00A	3-cluster Antenna Mount, 1.66"OD tube	40	36x8x8	 <p>6-cluster Antenna Mount Illustrated</p>
4.84.6CLS.00A	6-cluster Antenna Mount, 1.66"OD tube	80	36x16x8	

**P.E. Stamped Drawings** (for all States except Alaska and Hawaii – contact Trylon for pricing on Alaskan and Hawaiian stamps)

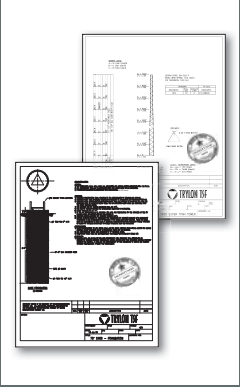
Part Number	Description	Ship Wt. (lbs)	Image
4.77.0101.900*	P.E. Stamped Dwg: Tower profile & standard FDN	2	
4.77.0101.940**	P.E. Stamped Dwg: Special soil FDN analysis & design	2	
4.77.0101.960	P.E. Stamped Dwg: Tower profile and special soil FDN	2	

- \* To order this P.E. stamped drawing, a completed "tower loading questionnaire" must accompany your PO to Trylon's distributor. Questions include: maximum design wind speed, radial ice accumulation, projected antenna area in sq. ft., etc.
- \* For bracketed structures contact Trylon for special P.E. stamped drawing quote.
- \*\* This requires an official geotechnical soils report to be submitted along with the purchase order for this special foundation design/analysis. PO will not be accepted without geotechnical soils report for the site in question.







# Terms and Conditions

---

**Acceptance.** Purchase Orders shall be considered final upon acceptance by Tylon TSF (hereafter "Supplier") by issuance of a written order confirmation. The issuance by Purchaser of a Purchase Order to Supplier shall constitute acceptance by Purchaser of these Terms and Conditions which shall supersede all additional or conflicting terms and conditions on Purchaser's Purchase Order. The contract between Purchaser and Supplier shall consist of Supplier's written confirmation and these Terms and Conditions.

**Pricing.** Price quotation and terms shall remain in effect for thirty (30) days from date of issuance. Supplier reserves the right to change published pricing at any time.

**Payment Terms.** Terms of payment shall be Net thirty (30) calendar days from the date of invoice for all Product shipped by Supplier.

**Finance and Collection Charge.** Purchaser agrees to pay a finance charge, at a monthly rate of 2%, on past due invoices where allowed by applicable law. Purchaser agrees to pay Supplier all costs of collection including but not limited to reasonable legal fees, collection fees and court costs incurred by Supplier to collect properly due payments.

**Taxes.** Purchaser is responsible for all sales, use, and similar taxes, and agrees to reimburse Supplier for any such charges paid on Purchaser's behalf.

**Credit Limits.** Credit limits shall be determined and modified at the sole discretion of the Supplier. In the event that Purchaser is delinquent in payment, Supplier may suspend any shipment or delivery or refuse to perform any work until all past due amounts, including finance charges, have been paid in full.

**Shipping Terms.** Shipping terms for shipments within Canada and the United States are F.O.B. Supplier's Point of Shipment. Shipping terms for international shipments are EXW Supplier's Point of Shipment (Incoterms 2000).

**Title and Risk of Loss.** Title to and risk of loss and damage to the Products shall pass to Purchaser immediately upon delivery of the Products to a common carrier, or to an employee or other agent of Purchaser, at Supplier's facility.

**Inspection.** Purchaser or its designated representative shall inspect all Products within seven (7) calendar days after delivery of Products (hereinafter "Inspection Period") and Purchaser shall notify Supplier of any defects, shortages, overshipments, or nonconformance in any of the Products. Any Products not rejected by Purchaser within such period shall be deemed to have been accepted by Purchaser.

**Shortages/Overshipments.** In the event that Supplier delivers less than the scheduled requirements and Supplier is notified of such shortage within the Inspection Period, Supplier shall correct such shortage within a commercially reasonable period of time after receipt of written notice from Purchaser or as otherwise agreed by the parties. If Supplier delivers more than the quantity ordered, Purchaser can return any excess Product at Supplier's expense or retain such excess as mutually agreed by the parties.

**Shipping Damage.** All claims for transportation damage shall be filed and processed by the Purchaser.

**Mode of Shipment.** In the event that the Purchaser specifies in a Purchase Order the shipping carrier, type of service, and payment method (collectively hereinafter "Mode of Shipment"), freight costs shall be charged in a manner consistent with the Purchase Order. In the event that Purchaser has not specified a Mode of Shipment on a Purchase Order, at the sole discretion of Supplier, such charges may be prepaid by Supplier and added to Supplier's invoice to Purchaser.

**Purchase Orders.** Purchaser shall order Products from Supplier by issuing a Purchase Order (hereinafter "Purchase Order(s)"). All Purchase Orders must be issued in writing and signed by Purchaser's authorized representative. Any and all pre-printed terms and conditions on Purchaser's forms and documents are null and void and hereby expressly rejected, and are superseded by the terms and conditions of this Agreement.

**Cancellation.** All requests for cancellation or changes of Purchase Orders must be submitted in writing by Purchaser. In the event that Purchaser cancels or changes a Purchase Order, Purchaser agrees to pay a restocking fee of not less than 35% for standard Products and 100% for custom Products of the dollar value of the Purchase

Order line item(s) cancelled.

## Returns.

(a) Purchaser may submit a request for return of Products once Products have been delivered to a common carrier, or to an employee or other agent of Purchaser, at Supplier's facility. All requests by Purchaser to return Products must be submitted in writing to Supplier utilizing Supplier's Return Request Form. Supplier shall not consider return requests received later than ninety (90) calendar days after shipment of Products.

(b) Supplier shall evaluate the Return Request Form in a timely manner. Supplier may, at its sole discretion, issue Purchaser written authorization to ship Product back to Supplier (hereinafter "Return Material Authorization"). The issuance of a Return Material Authorization is not acceptance of the returned Product, merely authorization to return the Product for inspection. In the event that Supplier deems that the request is not made in compliance with the terms of this Agreement, Supplier shall notify Purchaser in writing that the request for return has been denied.

(c) Upon receipt of such Products, Supplier shall inspect the Products and, at its sole discretion, accept or deny the return of such Products. In the event that Supplier accepts the return of Products from Purchaser, Supplier shall issue a credit to Purchaser in the amount of the original invoice amount for the Products less a restocking charge (hereinafter "Restocking Fee"). Purchaser acknowledges that customary Restocking Fees are 35% for standard Products and 100% for custom Products. In the event that Supplier denies the return of Products from Purchaser, Supplier shall ship Products back to Purchaser at Purchaser's sole expense. All shipping costs for the return of goods are the responsibility of the Purchaser. In the event that, upon inspection, Supplier determines that the Products are subject to the terms of Supplier's warranty or that the Products were shipped by the Supplier to Purchaser due to an error by Supplier, Supplier shall waive any Restocking Fees and shall issue a credit to Purchaser for any shipping costs for the shipment of Products back to Supplier.

**Specifications.** All Products shall be manufactured to meet Supplier's current manufacturing and engineering standards. All Products shall be packaged and labelled in accordance with Supplier's standard commercial practices. Supplier reserves the right to change or modify Products at any time.

**Warranty.** Supplier warrants that, at time of shipment, the Products furnished by Supplier are free from defects in material and workmanship. Supplier's obligation under this warranty is limited to repair and replacement of any defective Product within one (1) year from the date of shipment to the first Purchaser. Supplier shall have the sole discretion as to which of these remedies it shall provide. These warranties shall not apply to any Product which has been subjected to misuse, neglect, alteration, accidental damage, damage or defects attributable after shipment, defects during storage or installation, defects attributable to improper installation or use for purposes other than the Product was intended, and any other defects out of the reasonable control of Supplier. Seller makes no warranties, guarantees, covenants or representations other than those expressly set out in this Warranty. The warranties and remedies provided herein are Purchaser's sole and exclusive remedies and are provided expressly in lieu of all other warranties, whether express, implied, or arising by statute or otherwise in law or from a course of dealing or usage of trade, including but not limited to, warranties of merchantability or fitness for a particular purpose. Purchaser agrees that Supplier's liability under this Agreement, and any Purchase Order issued pursuant to this Agreement, shall never exceed the purchase price of the line item upon which liability is based. Under no circumstances shall Supplier be liable for consequential, incidental, special, direct, or indirect damages including but not limited to labour costs, installation costs, inconvenience, cost of replacement goods, loss of revenue or profits, or other costs of any nature as a result of the use of Products manufactured by Supplier.

**Force Majeure.** Supplier shall not be liable for failure to perform any of its obligations under this Agreement to the extent such failure is caused by fire; flood; explosion; war; riot; embargo; labour disputes; compliance with any laws, regulations, orders, acts or requirements from the government, civil or military authorities; acts of God or the public enemy; or any act or event of any nature beyond the Supplier's reasonable control. In no event shall Supplier be liable to Purchaser for any special, incidental, or consequential damages as a result of delay in performance or failure to perform hereunder.



# Trylon

21 South Field Drive, Elmira, ON N3B 0A6  
1-519-669-5421 (phone) 1-519-669-8912 (fax)  
[www.trylon.com](http://www.trylon.com) [info@trylon.com](mailto:info@trylon.com)